

MAX-PLANCK-INSTITUT FÜR WISSENSCHAFTSGESCHICHTE

Max Planck Institute for the History of Science

PREPRINT 150 (2000)

Jochen Büttner, Olivier Darrigol, Dieter Hoffmann,
Jürgen Renn, and Matthias Schemmel

Revisiting the Quantum Discontinuity

REVISITING THE QUANTUM DISCONTINUITY

Jochen Büttner, Olivier Darrigol, Dieter Hoffmann, Jürgen Renn, and Matthias Schemmel

PREFACE

This collection of essays is based on talks given on May 3, 2000 at a Boston Colloquium for Philosophy of Science dedicated to “Max Planck and the Quantum.” This colloquium was jointly organized by the Center for Philosophy and History of Science at Boston University and the Max Planck Institute for the History of Science, Berlin.

Honoring the centenary of Planck’s quantum hypothesis the colloquium discussed problems of the theoretical and experimental context of Planck’s discovery, as well as controversial issues concerning Planck’s role in the history of quantum theory. Apart from the papers collected here, the colloquium comprised the contributions “Planck’s Derivation of His Black-Body Radiation Law Revisited” by Michel Janssen (Boston University), “Helmholtz, Planck, and Berliner Theory” by Edward Jurkowitz (University of Illinois, Chicago), and “Wien and Einstein react to the Planck Spectrum: Where is the Discontinuity?” by John Stachel (Boston University).

By making available our papers in preprint form we want to encourage a continuation of the stimulating discussions at the Boston Colloquium, suggesting that it is now time for revisiting the quantum discontinuity.

Berlin, August 2000

Jochen Büttner
Olivier Darrigol
Dieter Hoffmann
Jürgen Renn
Matthias Schemmel

CONTENT

THE HISTORIANS' DISAGREEMENTS OVER THE MEANING OF PLANCK'S QUANTUM	3
---	---

Olivier Darrigol

EXPLORING THE LIMITS OF CLASSICAL PHYSICS— PLANCK, EINSTEIN, AND THE STRUCTURE OF A SCIENTIFIC REVOLUTION	23
--	----

Jochen Büttner, Jürgen Renn, and Matthias Schemmel

ON THE EXPERIMENTAL CONTEXT OF PLANCK'S FOUNDATION OF QUANTUM THEORY	45
---	----

Dieter Hoffmann

THE HISTORIANS' DISAGREEMENTS OVER THE MEANING OF PLANCK'S QUANTUM

Olivier Darrigol *

During the past twenty years, historians have disagreed over the meaning of the quanta which Max Planck introduced in his black-body theory of 1900. The source of this confusion is the publication, in 1978, of Thomas Kuhn's iconoclastic thesis that Planck did not mean his energy quanta to express a quantum discontinuity. The aim of the present essay is a comparison of the opinions of various historians on this issue.¹

Whether or not Planck introduced quantum discontinuity is an important question, for it affects our understanding of the origins of the quantum theory of Niels Bohr and Arnold Sommerfeld. Yet the focus on this question could bring with it a few misconceptions, which should be cleared out from the start. Firstly, one should not infer that the true meaning of the energy quanta was a central issue for Planck himself around 1900: what Planck emphasized was the introduction of two universal constants, h and k , and their power to bridge gas theory and radiation theory.² Secondly, one should not assume that historians of Planck's radiation theory completely disagree with each other: a consensus exists on many important features of Planck's program. Lastly, my focus on the intricacies of Planck's thoughts should not be mistaken as an indication that quantum theory was started in an exclusively individual manner. On the contrary, most early quantum concepts emerged through the confrontation and combination of the views of several physicists.³

The first section of this paper gives a classification of the various attitudes historians have taken towards Planck's quanta. In the second section, a correlation is established between the attitudes and the arguments used to support them. Next, the validity of these arguments is shown to depend on the historian's interest and methodology. In particular, it turns out that the historians who see in Planck the discoverer of quantum discontinuity relied not only on Planck's publications but also on the ways other physicists perceived and used his work. A last section is devoted to the consequences of a rigorous attention to the development of Planck's program in Planck's own understanding. Although Kuhn's thesis about the quantum discontinuity is thus

¹ T.S. Kuhn, *Black-body theory and the quantum discontinuity. 1894-1912* (Oxford, 1978). I thank John Stachel and Alfred Tauber for their hospitality at the Boston Colloquium, Edward Jurkowitz and Jürgen Renn for helpful comments.

² On this point see, e.g., M.J. Klein, "Max Planck and the beginnings of the quantum theory," *Archive for the history of exact sciences*, 1 (1962), 459-479, on 471; Kuhn, ref. 1, 110-113.

³ See the comments on the Einstein-Planck-connection in the contributions of J. Büttner, J. Renn, and M. Schemmel, and of J. Stachel to this conference, the former being reproduced in this collection.

* Chargé de recherches au CNRS Equipe REHSEIS

corroborated, his overall account turns out to be seriously flawed. The meaning of the steps taken by Planck in 1900 must instead be based on Allan Needell's profound study of Planck's attitude toward thermodynamic irreversibility.⁴

As a preliminary, it may help to recall aspects of Planck's radiation theory on which most historians would agree. In 1895, Planck started an ambitious program in which he hoped to provide an explanation of thermodynamic irreversibility based on electrodynamic processes. He was not satisfied with Boltzmann's similar attempt based on gas theory, for it led to a statistical understanding of irreversibility and thereby contradicted Planck's belief in the absolute validity of the entropy law. Besides, Planck knew from Gustav Kirchhoff that thermodynamic considerations could be applied to radiation at thermal equilibrium—the so-called black-body radiation—to derive the universality of its spectrum. Planck hoped that a simple electrodynamic model of the thermalization of radiation would lead to this fundamental spectrum, in which Berlin experimenters were increasingly interested for metrological reasons. The model he selected was a set of electric resonators (one for each frequency) enclosed in a cavity with perfectly reflecting walls.⁵

After a humbling exchange with Ludwig Boltzmann, Planck admitted that he could not obtain an irreversible evolution of his system without the *ad hoc* assumption of “natural radiation,” a formal counterpart of the assumption of molecular chaos which Boltzmann had introduced in order to justify his own irreversibility theorem (the H-theorem of 1872). Thanks to this assumption, the uncontrollable, irregular aspects of the evolution of the system were eliminated to yield a deterministic, irreversible evolution. In the case of equilibrium, Planck established the relation $u_\nu = (8\pi\nu^2/c^3)U$ between the spectral density u_ν of thermal radiation and the average energy U of a resonator at the frequency ν . His proof of irreversibility was based on the introduction of a monotonous entropy function depending on the observable properties of the resonators and the surrounding radiation.⁶

In 1899, Planck believed that the choice of this entropy function was uniquely determined by his irreversibility theorem. From the entropy $S(U)$ of a resonator, he could derive its time-averaged energy $U(T)$ through the thermodynamic relation $dS/dU = 1/T$ (T being the absolute

⁴ A. Needell, *Irreversibility and the failure of classical dynamics: Max Planck's work on the quantum theory: 1900-1915*, Diss., University of Michigan (Ann Arbor, 1980).

⁵ Cf. L. Rosenfeld, “La première phase de l'évolution de la théorie des quanta,” *Osiris*, 2 (1936), 148-196; Klein, ref. 2; “Planck, entropy, and quanta, 1901-1906,” *The natural philosopher*, 1 (1963), 83-108; Kuhn, ref. 1; Needell, ref. 4; O. Darrigol, *From c-numbers to q-numbers: The classical analogy in the history of quantum theory* (Berkeley, 1992), Part I. On the experimental side, cf. H. Kangro, *Vorgeschichte des Planckschen Strahlungsgesetzes* (Wiesbaden, 1970).

⁶ Planck could only obtain the spatial homogenization of radiation. The resonators could not change the spectrum of the radiation, as Ehrenfest and Einstein later noted.

temperature). The black-body spectrum then followed from the above relation between u_ν and U . Planck thus retrieved the exponential law which Wilhelm Wien had already suggested and which experiments seemed to confirm. A few months later, however, precise measurements of the infra-red tail of the spectrum exhibited violations of Wien's law. Planck then recognized that an infinite number of choices of the function $S(U)$, and therefore an infinite number of blackbody laws were in fact compatible with his irreversibility theorem.

In the Fall of 1900, Planck obtained a new black-body law by interpolating the second derivative d^2S/dU^2 —which played a central role in the derivation of his irreversibility theorem—between the values it takes for Wien's law (at large frequencies) and for the measured low-frequency part of the spectrum.⁷ The Berlin experimenters immediately confirmed this proposal. On December 14th, Planck presented a more fundamental proof of his new law at the German Physical Society Academy. Since the dynamics of his model had failed to provide the function $S(U)$, he appealed to Boltzmann's relation between entropy and probability $S = k \ln W$ in Planck's guise. He determined W by counting the number of discrete energy distributions over a set of identical resonators, in analogy with a prescription Boltzmann had given for a gas of molecules in 1877. Unlike Boltzmann, Planck gave to the discretizing energy-elements a completely determined value $h\nu$, where h is a universal constant with the dimension of action. Only thanks to this "most essential point" could the new black-body law be retrieved.⁸

1. HISTORIES

Statements on the meaning of Planck's energy quanta fall into three categories. According to the first category, in 1900 Planck introduced the idea that some microphysical entities (his resonators) could only have discrete energy values. According to the second, Planck did not know himself what the precise meaning of the energy quanta was. According to the third, Planck still believed that the energy of his resonators varied continuously, and he had no intention to revolutionize the laws of dynamics. Table 1 indicates the position of various historians in this scheme.

⁷ M. Planck, "Über eine Verbesserung der Wien'schen Spektralgleichung," Deutsche Physikalische Gesellschaft, *Verhandlungen*, 2 (1900), 202-204.

⁸ Planck, "Zur Theorie des Gesetzes der Energieverteilung im Normalspektrum," Deutsche Physikalische Gesellschaft, *Verhandlungen*, 2 (1900), 237-245, also in *Physikalische Abhandlungen und Vorträge* (Braunschweig, 1958), vol. 1, 698-706, on 700 (*wesentlichste Punkt*). Cf. Michel Janssen's contribution to this conference.

Table 1: Statements on Planck's quantum

Discontinuity	Indetermination	Continuity
Textbooks Klein 1961-7 Hund 1967 Jost 1995	Kangro 1970 Needell 1980, 1988 Galison 1981	Kuhn 1978
	Rosenfeld 1936 Jammer 1966	Planck 1920, 1943, 1948 Darrigol 1988, 1992

The discontinuity category is the most abundantly represented. The typical textbook story of Planck's discovery belongs to it, starting with the following extract of Sommerfeld's *Atombau und Spektrallinien*:

In several years of persistent efforts, Planck strove to penetrate electrostatics with the principles of thermodynamics. In order to thereby remain in agreement with experiments, he was finally forced to a daring challenge of the received conceptions of the wave theory, to his *hypothesis of energy quanta*: he required that the radiation energy of every frequency ν could only be emitted or absorbed by whole multiples of the elementary energy quantum $\varepsilon = h\nu$.

Accordingly, Sommerfeld made December 14th, 1900 the “birthday of the quantum theory.” Among historians, the most powerful discontinuist is Martin Klein. In papers written in the 1960s, Klein discussed Planck's program, his relation to Boltzmann, and his lack of concern for the Rayleigh-Jeans law. Although he did not dwell on the question of quantum discontinuity, he clearly took the discontinuist interpretation for granted. In 1961, comparing Einstein's and Planck's quantum considerations, he wrote: “Planck had quantized only the energy of the material oscillators and not the radiation.” In 1966, he spoke of a “strict quantization of the oscillator.” Most unambiguously, in his biography of Paul Ehrenfest he stated: “Planck had achieved his immediate goal. He had derived a radiation distribution law. But in order to do so he had taken a faithful step by requiring the energy of one of his oscillators always to be a multiple of an energy unit.” Klein admitted that Planck was not fully aware of the revolutionary character of this step: “A revolutionary idea,” he noted, “is not always recognized as such, not even by its propounder.” But the quantum step had been taken anyway. After the publication of Kuhn's contrary thesis, Klein maintained that “Planck's position in 1900...required discrete energy levels.”⁹

⁹ A. Sommerfeld, *Atombau und Spektrallinien* (Braunschweig, 1919), 3rd. ed. (1922), 44; Klein, ref. 2, 476; “Thermodynamics and quanta in Planck's work,” *Physics today*, 19:11 (1966), 23-32, on 28; *Paul Ehrenfest*, vol. 1: *The making of a theoretical physicist* (Amsterdam, 1970), 228; ref. 2, 476; Klein, contribution to “Paradigm lost? A review symposium,” *Isis*, 70 (1979), 429-433, on 430.

Physicist-historians have usually agreed with Klein's view. For example, in his *Geschichte* of 1967, Friedrich Hund wrote "Planck's hypothesis consisted in distributing energy quanta on material oscillators. A somewhat different emphasis [*Betonung*] gave the statement: harmonic oscillators have only the discrete energy $E = h\nu n$." Hund seems to have hesitated in identifying the distribution of quanta over resonators (for the purpose of an entropy calculation) with energy quantization. Yet he made Planck a quantizer by letting the *Betonung* float in the air. Most recently, in a violent reaction to Kuhn's book on quantum discontinuity, Res Jost returned to Planck's text of December 1900 and pronounced his "verdict against Kuhn": "The resonators of the frequency ν can only take energy in elements $\varepsilon = h\nu$."¹⁰

Other historians have been more nuanced discontinuists. In his old, insightful history of early quantum theory, Léon Rosenfeld insisted that Planck's definition of complexions, being based on finite energy-elements, contradicted classical statistical mechanics. But he noted that the new notion of 'energy element' entered Planck's statistical deduction of the black-body law "in a still rather obscure manner." Max Jammer, in his *Conceptual foundations* of 1966, similarly nuanced the account of Planck's quantum step: "Nowhere...did Planck bring into prominence the fundamental fact that U is an integral multiple of $h\nu$. At that time Planck was apparently not yet quite sure whether his introduction of h was merely a mathematical device or whether it expressed a fundamental innovation of profound physical significance."¹¹

This statement brings us close to the indeterminist historians, for whom Planck did not really know what he was doing, so that one should not read too much in his formal deductions. A first example of this prudent attitude is found in Hans Kangro's *Vorgeschichte* of 1970: "At that time [1900], Planck cannot have been aware of the bearing in the system of physics of the assumption of energy elements—which also exist in Boltzmann." Kangro here alluded to the analogy between Planck's and Boltzmann's combinatorics: what Boltzmann did not intend to be revolutionary could not be either in Planck's tentative transposition of Boltzmann's reasonings. In his dissertation of 1980, Allan Needell offered other reasons to leave the meaning of Planck's energy quanta in the dark: "Planck was not concerned with describing details of the motion or behavior of an oscillator...The question of whether Planck introduced quantum discontinuities in 1900 is not a major issue; the answer depends on the attitude toward physical concepts and on the level of commitment one requires to credit someone with such an introduction." Therein Needell made a historical point, that Planck, in his program, deliberately left the detailed behavior of his resonators undetermined; and a methodological point, that historians should dis-

¹⁰ F. Hund, *Geschichte der Quantentheorie*, 25; R. Jost, "Planck-Kritik des T. Kuhn," in *Das Märchen vom Elfenbeinernen Turm. Reden und Aufsätze* (Berlin, 1995), 67-78, on 72.

¹¹ Rosenfeld, ref. 5, 166; M. Jammer, *The conceptual development of quantum mechanics* (New York, 1966), 22. Armin Hermann adopted a similar attitude in his *Frühgeschichte der Quantentheorie (1899-1913)* (Mosbach, 1969), 34-35.

tinguish different degrees of commitment of a given actor on a given issue. In a review of the Klein-Kuhn controversy published in 1981, Peter Galison adopted a similar stance: “The question of the continuum vs. discreteness as such, which for us is of such overwhelming interest, was entirely peripheral to Planck’s other concerns...It is not always possible to impose a self-consistent, fully articulated set of beliefs on a scientist’s view of his problem, especially at periods of great upheaval.”¹²

The third kind of historian of Planck’s quantum is the continuist one, who makes the energy of Planck’s resonators a continuous variable despite Planck’s formal use of energy-elements. Thomas Kuhn inaugurated this trend in 1978 with his book on *Black-body theory*. A typical statement of Kuhn’s reads: “The concept of restricted resonator energy played no role in [Planck’s] thought until after the *Lectures* [of 1906].” In 1988, I have defended the same thesis on a different basis and with a twist: whereas Kuhn made Planck a persistently classical physicist, I believe with Needell that Planck left a non-classical behavior of his resonators open. Moreover, Needell has rightly noted that the word “classical” points to a post-quantum-theoretical idealization of nineteenth-century physics that does not apply to the multiple, open, evolving theories of the turn of the century.¹³

Interestingly, Planck’s own retrospective appraisals of his 1900 breakthrough do not corroborate the discontinuist account. Instead they must be situated somewhere in between the indeterminist and the continuist categories. In his Nobel lecture of 1920, Planck wrote:

Whereas [the constant h] was indispensable—for only with its help could the size of the...‘elementary domains’ or *Spielräume* of the probability be determined—it proved to block and resist every attempt at fitting it into the frame of classical theory...The failure of all attempts...soon left no doubt: either the quantum of action was only a fictitious quantity, or the derivation of the radiation law rested on a truly physical thought...Experiments have decided in favor of the second alternative. But science does not owe the prompt and indubitable character of this decision to tests of the law for the energy distribution of thermal radiation, and even less to my special derivation of this law; it owes that to the unceasing progress of the researchers who have put the quantum of action to the service of their investigations. A. Einstein made the first breakthrough in this domain.

¹² H. Kangro, ref. 5, 225-226; Needell, ref. 4; Introduction to Planck, *The theory of radiation* (Los Angeles: Tomash, 1988), xix; P. Galison, “Kuhn and the quantum controversy,” *British journal for the philosophy of science*, 32 (1981), 71-85, on 82. J. Mehra and H. Reichenberg (see the first volume of their history of quantum theory), could also be regarded as indeterminist, for they simply paraphrase Planck’s paper and do not offer any interpretation of their own.

¹³ Kuhn, ref. 1, 126; Darrigol, “Statistics and combinatorics in early quantum theory,” *Historical studies in the physical sciences*, 19 (1988), 18-80; ref. 5; Needell’s remark is in ref. 11.

Clearly, Planck did not regard the physical significance of energy quanta as established by his own work on radiation. In his own view, the decisive steps in this regard were Einstein's and others applications of the quantum to non-thermal phenomena such as the photoelectric effect, specific heats, and atomic spectra. Planck never claimed responsibility for the revolution of which a long historiographical tradition makes him the hero. "The introduction [of the constant h]," he pondered at the close of his life, "meant a much more radical break from classical theory than I had initially suspected."¹⁴

2. ARGUMENTS

The multiplicity of the interpretations of Planck's quantum corresponds to a diversity in the kind of arguments that sustain these interpretations. This is indicated in Table 2.

Table 2: Arguments

1) Tradition	Hund, Jost	Klein	
2) Planck's proof of 1900			
3) Statistical thermodynamics			
4) Contemporary readings			
5) Planck's asserted goals	Kangro, Needell, Galison		Kuhn, Darrigol
6) Formal heuristics			

Those who see quantum discontinuity in Planck's work tend to refer to historiographical tradition. Hund implicitly cites Sommerfeld by making December 14th, 1900, the birthday of the quantum theory. Jost accuses Kuhn of neglecting the collective memory of physicists. Klein, as a sophisticated historian, is more critical of traditional accounts and spends much time correcting errors regarding Planck's awareness of the Rayleigh-Jeans law or his use of Boltzmann's method. Yet his insistence on the revisionist character of Kuhn's thesis betrays a basic trust in those aspects of the history of quantum history that were never questioned before Kuhn. His review of Kuhn's book portrays it as an *abusive* revision: "By insisting so strongly on this rad-

¹⁴ Planck, "Die Entstehung und bisherige Entwicklung der Quantentheorie" (Nobel lecture, 1920), in *Physikalische Abhandlungen und Vorträge* (Braunschweig, 1958), vol. 3, 121-136, on 127; "Wissenschaftliche Selbstbiographie," *ibid.*, 374-401, on 397.

ical revision of all previous accounts, Kuhn has put himself in a position that requires him to explain away part of the available evidence and to look at the rest of it from the standpoint of his central thesis.”¹⁵

The discontinuist historians also share a reference to the supposed transparency of Planck’s original proof of the blackbody law. They usually cite the following extract of Planck’s talk of December 14th:

When E [the energy to be distributed over N resonators with the frequency ν] is regarded as an indefinitely divisible quantity, the distribution can be done in an infinite number of ways. However, we regard E —this is the most essential point of the whole calculation—as made up of a completely determined number of identical finite parts; and for this purpose we use the constant of nature $h = 6.55 \times 10^{-27}$ erg \times sec. This constant, multiplied by the common frequency ν of the resonators, gives the energy-element ϵ in erg, and by division of E by ϵ we get the number P of energy-elements which are to be distributed over the N resonators.

Therefrom it seems obvious that the energy of a resonator can only be an integral multiple of ϵ , since it is obtained by the distribution of energy-elements.¹⁶

Interestingly, the next sentence of Planck’s text has almost never been quoted. It reads: “When the thus computed ratio $[E/\epsilon]$ is not a whole number, one can take for P a neighboring whole number.” This sentence should be problematic for the discontinuist interpreter of Planck, for it clearly indicates that Planck did not expect the energy of his set of resonators to be an integral multiple of ϵ ; *a fortiori*, he could not expect the energy of an individual resonator to be quantized. But this is the kind of detail that is easily filtered out by a prejudiced reader. The one physicist-historian who does quote the embarrassing sentence, Res Jost, pronounces his anti-Kuhn “verdict” right after it.¹⁷

Another argument in favor of the discontinuist interpretation appeals to the fact that statistical mechanics, if properly applied to a classical radiating system, necessarily leads to the Rayleigh-Jeans law. In many textbook accounts, Planck is said to have been aware of this fact and to have introduced quantum discontinuity in order to avoid this absurd consequence of the classical theory. Klein rightly rejected this view and suggested instead that Planck was too unfamiliar with statistical mechanics to understand the fact. But Klein still used his own knowledge of classical implications to infer that Planck’s demonstration only made sense if the resonators were quan-

¹⁵ Hund ref. 10; Jost, ref. 10; Klein, ref. 2; ref. 9, 430.

¹⁶ Planck, ref. 8, 700-701.

¹⁷ Planck, ref. 8, 701; Jost, ref. 10. The sentence is not in Planck’s subsequent *Annalen* paper: “Über das Gesetz der Energieverteilung im Normalspectrum,” *Annalen der Physik*, 4 (1901), 553-563, also in *Physikalische Abhandlungen und Vorträge* (Braunschweig, 1948), vol. 1, 717-727.

tized. More exactly, Klein assumed that in 1900 Planck adopted Boltzmann's relation between entropy and probability; this relation could only lead to Planck's law if the resonators were quantized, against Boltzmann's original intentions and against the consequences of classical statistical mechanics (which included the equipartition theorem).¹⁸

By using this kind of argument, Klein imitated early interpreters of Planck's paper such as Hendrik Lorentz, James Jeans, and Albert Einstein. In his review of Kuhn's book, he insisted that these early readings of Planck revealed the essence of Planck's theory: "The quanta were there in [Planck's] theory, and some of his readers did draw attention to them: Lorentz in 1903, Ehrenfest and James Jeans in 1905...Lorentz wrote in 1903 about Planck's use of 'a certain number of finite portions' of energy. I see this as Lorentz's recognition of what Planck had done in his papers of 1900 and 1901." In his paper of 1961, Klein already used Jeans' and Ehrenfest's readings of Planck to characterize Planck's departure from Boltzmann's methods. In particular, he agreed with Ehrenfest that "Planck's energy elements amounted to a radical change in the *a priori* weight function introduced into phase space": whereas Boltzmann assumed a uniform weight, Planck allowed only discrete energy values.¹⁹

Klein was also sensitive to the programmatic aspects of Planck's radiation theory. He rightly emphasized that the meaning of entropy was the leading thread of Planck's program, and gave as much importance to the evolution of Planck's concept of entropy as to the steps necessary to his derivations of the black-body law. However, Klein did not pursue his exploration of Planck's program far enough to perceive contradictions with the received view on Planck and quantum discontinuity. We will see in a moment that the indeterminist and continuist readings of Planck resulted from a more sustained attention to Planck's expressed goals.²⁰

Lastly, a few historians of Planck's theory have tried to reconstruct the formal and symbolic operations through which Planck reached the various steps of his radiation theory. Although some of that is found in Rosenfeld's and Klein's pioneering studies, Kuhn and myself made the strongest efforts to capture the detailed interweaving of programmatic goals and formal procedures. We thus hoped to shed light on Planck's theoretical style in general, and on the nature of his energy-elements in particular.²¹

¹⁸ Klein, ref. 2, 464-468, 474: "It is obviously of the very essence of Planck's work that ϵ should not vanish, if the proper distribution law were to be reached. Planck apparently did not even consider the possibility of taking this limit. This is undoubtedly related to Planck's apparent unawareness of the equipartition theorem and all it implied."

¹⁹ Klein, ref. 9, 431; ref. 2, 475.

²⁰ Klein, ref. 5.

²¹ Rosenfeld, ref. 5; Klein, ref. 2; Kuhn, ref. 1; Darrigol, ref. 5.

To sum up, the continuist historians are those who have most closely studied Planck’s intricate considerations from the beginning of his program in 1894, through the quantum papers of 1900 and 1901, to later elaborations between 1906 and 1914. The indeterminist historians have focused on Planck’s expressed goals. The discontinuist ones have given more weight to historiographical tradition, to the formal structure of Planck’s reasonings of 1900 and 1901, and also, in Klein’s case, to contemporary readings of Planck’s texts.

3. METHODS

These various argumentations raise methodological questions on the assessment of individual discovery:

1. Can a historian give weight to traditional accounts?
2. Can the formal skeleton of a demonstration speak for itself?
3. Can the historian of a discovery rely on contemporary views not necessarily held by the discoverer?
4. Can he rely on contemporary accounts?
5. Does he need to retrace the discoverer’s path?
6. Should he worry about formal, technical details of this path?

(The words “discovery” and “discoverer” are used in a conventional manner, to point to the work and to the actor who have been traditionally regarded as bringing some essential new knowledge). The answer to these questions depends on the historian’s interest. Table 3 schematizes this effect for three kinds of interest to be now described.

Table 3: Interests / arguments

	Discoverer’s way	Impact of discovery	Credit
(1)	No	Yes	Yes
(2)	No	Yes	Yes
(3)	No	Yes	May be
(4)	No	Yes	May be
(5)	Yes	May be not	Not really
(6)	Yes	May be not	Not really

First suppose that we are trying to decide what the discoverer, Planck, thought he was doing in 1900. In this case, we need to handle traditional accounts with systematic suspicion, for it is well known that the simple narratives generated and stabilized by a given community of scientists may have little relation with the actual performance of the discoverer. We must also be weary of trusting the appearances of the formal apparatus of past demonstrations, for we may unconsciously interpret this apparatus in terms of later knowledge that may be incompatible with the discoverer's views. Similarly, we should be alert to possible contradictions between these views and those projected by contemporary actors on the discoverer's work. We must of course retrace the discoverer's path, because it usually contains important implicit aspects of his final reasonings. Formal, technical details of this path may thereby help, for they have every chance of being intimately connected with more qualitative elements. They are basic data to anyone interested in the process of theory construction.

A historian may, however, be less interested in the idiosyncrasies of Planck's approach than in the way his work was used by other proto-quantum-theorists. Then he would give significantly different answers to our methodological questions. If used with sufficient care, traditional accounts may be more helpful to him, because they often reveal features of the early reception of the discoverer's work: the canonical story of a discovery (if there is any) is usually formed little after its impact has been recognized, on the basis of the most common perception of the discovery, which may differ from the discoverer's own perception. The early users of the discoverer's work are in fact often *reinterpreting* this work: they extract some elements of this work and combine them with other elements and views that may be incompatible with those of the discoverer. The purely formal aspects of the discoverer's work may then be essential, for they may be all what the users retain. So can be the users' views, for they condition the process of reinterpretation. In contrast, the discoverer's path becomes irrelevant in so far as it is ignored by his followers.

Lastly, a physicist-historian could be interested in considerations of credit: Is it legitimate to make Planck the father of the quantum theory? Then our methodological questions would receive still different answers, because the factors contributing to the attribution of credit are more diverse and more inconsistent than those allowed in strict history. What the discoverer actually intended to do is only one factor. The impact of his seminal work, including useful reinterpretations or misinterpretations, may be more important. His overall achievements, both scientific and institutional, may also count. Owing to this complexity, the weight of tradition is considerable, and revisions are extremely rare.

Consider, for instance, the case of J.J. Thomson *qua* discoverer of the electron. Historians (should) know that the new particle described by Thomson in 1897 had less resemblance with the modern electron than the one announced a few months earlier by Emil Wiechert. Yet they would have a hard time convincing physicists to change the traditional story of the discovery of the electron, for this story serves pedagogical purposes, a popular empiricist view of the formation of concepts, and the memory of J.J. Thomson—who certainly achieved much as the head of the Cavendish Laboratory. As an other instance, Erwin Schrödinger is regarded as a co-founder of quantum mechanics, even though his original interpretation of the wave equation turned out to be incompatible with later quantum mechanics. In contrast, Poincaré is usually not regarded as a cofounder of relativity theory, even though he had all the formalism of Einstein's relativity theory and an interpretation of this formalism empirically equivalent to Einstein's.

To sum up, the adequacy of the arguments used by the tellers of Planck's discovery cannot be judged in an absolute manner. It varies according as our interest lies in the discoverer's way, in the impact of discovery, or in credit attribution. From the preceding discussion, it seems to follow that the continuist and indeterminist historians were more interested in Planck's genuine intentions, and the discontinuist ones in the impact of his work or in the credit to be given to him (compare Tables 2 and 3). The reality is more subtle. All historians and physicists write as if they were respecting Planck's intended meanings. Yet it seems likely that the physicist-historians were haunted by considerations of credit. Martin Klein, being a professional historian, cannot have followed this inclination. However, as Ehrenfest's biographer and as a student of Einstein's papers on radiation, he had an outstanding interest in the exploitation of Planck's work by contemporary physicists.

The discontinuist histories are acceptable and interesting, as long as they are taken for what they truly are: histories motivated by credit attribution or by assessment of the impact of discovery. They are misleading, however, if they are taken to reflect Planck's actual intentions. How credit is attributed is a genuinely interesting historical question, which may teach us a lot on the physicists' community in a given period; but the attribution of credit is not itself the historian's business. As for the impact of discovery, it is of course a legitimate interest of the historian's. But the views of the discoverer should be clearly distinguished from those of his interpreters. Unlike historians, a scientist rarely seeks to penetrate a colleague's mind very deeply; he rather extracts whatever seems useful to him and reconstructs it in harmony with his own views. These creative reinterpretations constitute an essential part of the overall process of discovery. They deserve special attention from historians and philosophers of science.²²

²² See the contribution to this conference by J. Büttner, J. Renn, and M. Schemmel, reproduced in this collection.

4. QUANTUM CONTINUITY

The previous discussion raises doubts on the soundness of the method followed by discontinuist historians. It is not sufficient, however, to disprove their claim regarding Planck's introduction of quantum discontinuity. For this purpose, a more detailed consideration of the arguments of indeterminist and continuist historians is necessary.

Kuhn's continuist thesis is essentially based on three arguments. Firstly, Planck needed the classical theory of radiation in order to derive the relation $u_\nu = (8\pi\nu^2/c^3)U$ between the spectral density u_ν of thermal radiation and the average energy U of a resonator at the frequency ν . Therefore, he could not assume a quantization of the resonator without contradicting himself. Secondly, in his combinatorial derivation of the black-body law, Planck proceeded by analogy with Boltzmann's combinatorics of 1877. Therefore, his recourse to a distribution of energy-elements is likely to have been only a shortcut to Boltzmann's fuller consideration of equiprobable energy-intervals (or cells in velocity space): for the counting of complexions, it does not matter whether a complexion is defined by giving to each molecule a discrete energy or by stipulating to which interval of the energy axis the molecule belongs. Thirdly, in 1906 Planck explicitly defined his complexions in terms of equiprobable intervals rather than discrete energies. It seems extremely unlikely that in 1900 he would have used sharp quantization, only to retreat to a more closely Boltzmannian approach in 1906.²³

Kuhn's argumentation looks strong. Yet it failed to convince Martin Klein and most of the physicists interested in the issue. It would be too easy to interpret this persistent disagreement in terms of pride and prejudice. In fact, there are flaws in Kuhn's arguments, and a few errors and omissions in his reading of both Planck and Boltzmann. For example, Allan Needell and Res Jost have rightly noted that Planck's conversion to Boltzmann's statistical conception of irreversibility occurred several years after 1900, whereas Kuhn dates this conversion in 1897-8 with the introduction of "natural radiation." Martin Klein, who has the deepest knowledge of Boltzmann's kinetic theory, noted that Kuhn had overlooked the aspects of Boltzmann's work that anticipated statistical mechanics. Kuhn had difficulty finding his way in the mathematical thicket of Boltzmann's and Planck's theories, and he sometimes got lost despite the avowed assistance of a few physicist friends. Anyone who feels this lack of ease in Kuhn's investigations, tends to distrust his more iconoclastic conclusions.²⁴

²³ Kuhn, ref. 1, especially 125-127.

²⁴ Needell, ref. 4; Jost, ref. 10, 70; Klein, ref. 9, 432; Kuhn, ref. 1, xii.

Even so, Kuhn's adversaries seem to have overlooked the gravest flaw of his argumentation. If, as Kuhn insists, Planck in 1900 was faithfully following Boltzmann's procedures, he should have reached the Rayleigh-Jeans law instead of Planck's law, for in Boltzmann's gas case the size of the cells (the counterpart of Planck's energy-elements) disappears from the final entropy formula. Then there must have been some inconsistency in Planck's application of Boltzmann's method. Now we face the following dilemma: in order to accept Kuhn's first argument about the derivation of the relation between spectral density and resonator energy, we must assume Planck to be a consistent thinker; in order to accept his second argument on the nature of Planck's combinatorial entropy derivation, we must assume Planck to be an inconsistent thinker.

One way to avoid this dilemma is found in Klein's review of Kuhn's book: we may assume that Planck was *uniformly inconsistent*. In this view, Planck tolerated or overlooked two contradictions: that between the derivation of $u_\nu = (8\pi\nu^2/c^3)U$ and resonator quantization, and that between Boltzmann's method and resonator quantization.²⁵ A more convincing way out of the dilemma is given by the opposite assumption that Planck was *uniformly consistent*: his resonator entropy calculation contradicted neither the derivation of $u_\nu = (8\pi\nu^2/c^3)U$ nor the relation between entropy and probability, *because Planck understood this relation in a way different from Boltzmann's*.

The basic point overlooked by Kuhn is that in 1900 (or before) Planck did not adopt the statistical conception of irreversibility. He did so only around 1914. Therefore, despite formal similarities Planck's entropy/probability considerations fundamentally differed from Boltzmann's. This fact turns out to be essential to a proper understanding of the status of Planck's energy-elements. Allan Needell, a student of Martin Klein, has solidly established this new vision of Planck's radiation theory in his dissertation of 1980. His argument goes as follows.²⁶

Planck's resonators, responsible for the thermalization of radiation, were not meant as elastically bound ions or other similar atomistic systems. When Planck began his program, he was hostile to microphysical speculations and preferred considerations based on general, macroscopic principles. Accordingly, he regarded his resonators as miniature versions (much smaller than the corresponding wavelength) of Heinrich Hertz's resonators with no ohmic resistance *and with indeterminate internal structure*. He derived the relation between the electric dipole of a resonator and the surrounding field by comparing the energy fluxes across well-chosen surfaces

²⁵ Klein, ref. 9, 431.

²⁶ Needell, ref. 4.

surrounding the resonator. As was shown in Edward Jurkowitz's contribution to this conference, this type of reasoning was typical of Planck and of the Berlin physics inaugurated by Hermann Helmholtz.

The resulting relations between the observable, secular properties of resonator and radiation were not completely determinate, for they involved unknown phase differences between radiation and resonator. Planck exploited the indeterminate internal structure of his resonators to drop the phase-dependent terms, so that the evolution of the controllable aspects of his system became deterministic and irreversible. The idea was that the internal intricacies of resonator dynamics conspired to rigorously cancel the unwanted terms. This assumption of "natural radiation" differed from Boltzmann's analogous "molecular chaos" in an essential manner: it yielded a strict validity of the entropy law, whereas Boltzmann only obtained a statistical validity of this law.

When in 1900 Planck appealed to Boltzmann's relation between entropy and probability, he still avoided the statistical conception of irreversibility. He reinterpreted the "probability" in Boltzmann's relation as a measure of the elementary disorder implied in natural radiation and bound to strict irreversibility. Accordingly, Planck's W depends on the indeterminate internal structure of the resonators. There follows an important corollary: the energy-elements occurring in the calculation of W pertain to the finer details of resonator dynamics and do not contradict the secular, large-scale application of electrodynamics that Planck made in his derivation of relations between radiation and resonator properties. The relevant connections of Planck's program are visualized on Table 4.

Table 4: Planck's scheme

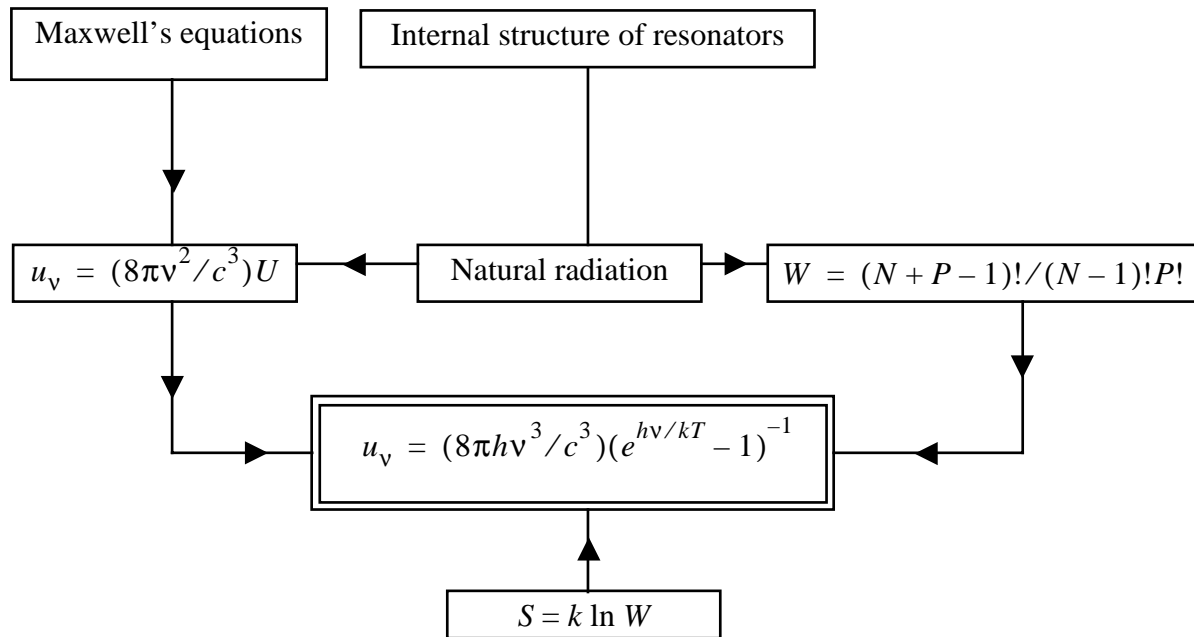

These remarks of Needell's explain why there is no contradiction between Planck's resonator-entropy calculation and his earlier derivation of the relation between U and u_ν . They also make clear that for Planck the deeper significance of the energy-elements was an open question, having to do with electrodynamics at a finer, non-observable scale. This is why Needell adopted the indeterminist position with regard to Planck's introduction of quantum discontinuity. More generally, Needell excludes any application of the modern distinction between classical and quantum physics to Planck's work, because for Planck and his contemporaries there was no such thing as a closed, uniform doctrine of physics which the black-body spectrum could be said to contradict.²⁷

In a paper published in 1988, I came to conclusions very close to Needell's (without having seen his dissertation). My motivation was different. Needell had followed the history of Planck's understanding of irreversibility, from his dissertation on the entropy law to his late conversion to Boltzmann's statistical view. Instead I was interested in the formal analogies between Boltzmann's and Planck's theories and in their role in the construction of proto-quantum formalisms. Owing to this different emphasis, I pursued the formal consequences of Planck's interpretation of combinatorial probability as a measure of elementary disorder, with the following results.²⁸

According to Planck, the kinds of disorder involved in gas theory and in radiation theory are different: the disorder is spatial in the former case, and temporal in the latter. Consequently, the "probabilities" measuring the disorder are expressed by different formulas. In other words, the

²⁷ Needell, Introduction to M. Planck, *The theory of heat radiation* (Los Angeles: Tomash, 1988), xi-xliii.

²⁸ Darrigol, ref. 5; ref. 13.

characterization of the macrostate is different for Boltzmann's gas and for Planck's resonator. For Boltzmann, a macrostate of the gas is given by the list of the numbers N_i of the molecules with the energy $i\varepsilon$ (better: whose energy lies between $i\varepsilon$ and $(i + 1)\varepsilon$), whereas for Planck a macrostate of a set of resonators is given by the total energy of this set. Naturally, Boltzmann chooses the energy-element ε so small that the distribution N_i is approximately continuous (and large enough so that the Stirling approximation can be used for $N_i!$). In contrast, this distribution has no observable significance in Planck's case, so that there is no upper limit on the size of ε . This explains why ε survived in Planck's final entropy formula whereas it disappeared in Boltzmann's. Both this strange feature and the difference between Planck's and Boltzmann's combinatorial formulas are intimately related to the temporal nature of the disorder involved in natural radiation.

Accordingly, the singularity of Planck's reasoning and his ability to retrieve the new black-body law much more depended on his definition of macrostates than on his definition of microstates or complexions. He could equally well define the complexions in the discrete manner of Boltzmann's fiction, or in the continuist guise of energy-interval ascriptions. A rudimentary knowledge of Planck's psychology, and continuity with the presentation found in his lectures of 1906 make it extremely plausible that he shared Boltzmann's preference for the continuist version. He only used the discontinuist version because, *for his definition of a macrostate*, it led to a much quicker calculation of the number of complexions. The last trace of doubt is removed by the earlier quoted clause in the paper of December 1900 ("When the thus computed ratio $[E/\varepsilon]$ is not a whole number, one can take for P a neighboring whole number") and by Planck's reference to Johannes von Kries' *Spielräume* in the *Annalen* paper of 1901. By *Spielräume*, Kries meant domains of equiprobability for probability distributions of *continuous* variables. Planck later used the word as synonymous of his own *Elementargebiete der Wahrscheinlichkeit*. For all these reasons, we must agree with Kuhn that Planck did not intend to restrict the energy of his resonators to discrete values in 1900-01.²⁹

²⁹ Planck, ref. 8, 701; ref. 17, 722; J. von Kries, *Die Principien der Wahrscheinlichkeitsrechnung* (Freiburg, 1886), 36; For Planck's identification of *Spielräume* and *Elementargebiete*, see ref. 14 (Nobel lecture), 127; Kuhn, ref. 1, 121, 286, notes Planck's reference to Kries, but overlooks its meaning. I thank Michael Heidelberger for discussing the matter with me and for lending me a copy of Kries' book.

5. CONCLUSION

In the previous section, we have tried to understand Planck's theory of radiation in its own terms, without the deforming lense of contemporary and later interpretations by other physicists. This is of course what Kuhn himself wanted to do. According to his methodology, the incommensurability of different systems of thoughts implies that the historian should penetrate the thoughts of past scientists without injecting elements of later systems. This task requires attention to small details and apparent contradictions which ultimately reveal the original coherence of the studied thought in a sort of "Gestalt"-switch. In his black-body book Kuhn wanted to reveal the true coherence of Planck's radiation physics, just as his teacher Alexandre Koyré had revealed the coherence of Aristotelian physics.³⁰

Kuhn partly succeeded in this enterprise by removing some apparent contradictions of Planck's theory and giving more continuity to its evolution. However, he failed to notice the essential aspects of this theory which Allan Needell discussed in his dissertation. He committed precisely the kind of methodological error with which he reproached other historians: he confused Planck's reinterpretation of Boltzmann with Boltzmann himself. He failed to perform the "Gestalt"-switch that would have revealed the full coherence of Planck's approach.

So far I have spoken as if Kuhn's methodology was obviously sound, as if the reconstruction of the assumed coherence of a past system was a legitimate goal. Yet we saw that Galison reproached Kuhn with assuming too much coherence in Planck's thoughts at a time of fast and chaotic change. Similarly, in his review of Kuhn's book Klein wrote: "In my opinion Kuhn tries too hard to establish the internal consistency of Planck's position. He seems to be unwilling to consider the possibility that Planck himself was not always completely clear about what he was doing." The objection seems even more pertinent for accounts such as Needell's and mine which convey to Planck's thoughts more coherence than Kuhn himself perceived. The problem is whether the coherence is artificially introduced by the historian or is a genuine characteristics of the described thoughts.³¹

Klein's doubts are understandable in the case of Kuhn's book, for Kuhn makes assumptions of internal consistency (his first point) and temporal continuity (his third point) for which he gives not textual evidence. Moreover, Kuhn appears to have arbitrarily made Planck consistent on

³⁰ Cf. Kuhn, *The essential tension* (Chicago, 1977), xii: "I offer [students] a maxim: When reading the works of an important thinker, look first for the apparent absurdities in the text and ask yourself how a sensible person could have written them. When you find an answer, I continue, when those passages make sense, then you may find that more central passages, ones you previously thought you understood, have changed their meaning."

³¹ Klein, ref. 9, 431.

some issues and inconsistent on others. Do these charges also apply to the accounts given by Needell and myself? I do not think so, for these accounts follow very closely Planck's expressed justifications. For example, Needell's crucial point that Planck understood the combinatorial probability as a measure of elementary disorder is completely explicit in the quantum papers of 1900-01. Planck starts his reasonings with the words "Entropie bedingt Unordnung," and goes on to characterize the kind of disorder affecting his resonators.³² It is in fact easier to locate statements of Planck's corroborating Needell's account than to understand why previous historians overlooked them.

In short, I believe the coherence which Needell saw in Planck's approach to the radiation problem to be real. Coherence, however, should be confused neither with consistency nor with completeness. Let us define consistency as the lack of logical contradiction in an entirely explicit, closed, conceptual system. Consistency in this sense is never achieved during the construction of a theory. It can only be reached in a later stage of consolidation and axiomatization. In contrast, coherence refers to a harmonious weaving of arguments without easily perceptible contradictions. Planck's theory was coherent in this soft sense; but it could not be made consistent in the hard sense. For example, if Planck had provided a physical mechanism for the thermalization of his resonators (such as encounters with gas molecules), he would have been forced to the absurd Rayleigh-Jeans law. His theory was incomplete in a way that hid potential contradictions.

Incompleteness was an essential characteristics of Planck's theory, as emphasized by Needell and myself. Accordingly, Planck had no definite opinion of the exact meaning of his new quanta. He strove to remain as close as possible to received dynamic conceptions, but he did not know what the exact dynamics of the resonators would be. He did not introduce quantum discontinuity, he did not intend a sharp break from received theories, but he believed that his quantum of action signalled yet unknown aspects of small-scale physics.

³² Planck, ref. 8, 698.

EXPLORING THE LIMITS OF CLASSICAL PHYSICS—

PLANCK, EINSTEIN, AND THE STRUCTURE OF A SCIENTIFIC REVOLUTION

KUHN'S NEGLECTED QUESTIONS	23
THE QUANTUM REVOLUTION – A PARADIGM OF KUHN'S THEORY?	23
THE RECEPTION OF KUHN'S THEORY	25
BACK TO KUHN'S QUESTIONS	26
EINSTEIN'S DISINTEGRATION OF CLASSICAL PHYSICS	26
PLANCK'S RESONATORS IN CONTEXT	26
PLANCK'S RESONATORS IN CRISIS	31
PLANCK'S RADIATION IN CRISIS	36
THE QUANTUM DISCONTINUITY AS A BORDERLINE PROBLEM OF CLASSICAL PHYSICS	42
BIBLIOGRAPHY	44

EXPLORING THE LIMITS OF CLASSICAL PHYSICS—
PLANCK, EINSTEIN, AND THE STRUCTURE OF A SCIENTIFIC REVOLUTION

Jochen Büttner, Jürgen Renn, and Matthias Schemmel

KUHN'S NEGLECTED QUESTIONS

THE QUANTUM REVOLUTION – A PARADIGM OF KUHN'S THEORY?

The emergence of the quantum theory in the beginning of the last century is generally seen as a scientific revolution *par excellence*. Although numerous studies have been dedicated to its historical analysis, there is so far only one major work available with an explicit historical theory of scientific revolutions in the background, Thomas Kuhn's *Black-Body Theory and the Quantum Discontinuity* of 1978.³³ But surprisingly, this study contains no explicit reference to the terminology of the program outlined in Kuhn's path breaking theoretical work, *The Structure of Scientific Revolutions*.³⁴ In commentaries on his work, Kuhn makes it, however, clear that he did consider his book as a case study exemplifying his program and illustrating what he conceived to be characteristic features of a scientific revolution.³⁵ Kuhn's theoretically guided analysis implies two dazzling conclusions. First, according to Kuhn, the assumption of a quantum discontinuity in the distribution of energy was not introduced by Planck in 1900 but only by Einstein and Ehrenfest in 1906. Second, Kuhn's analysis suggests that it makes sense to consider the short span of time between Planck's publication of his formula for heat radiation in 1900 and the more or less general recognition of the need for quantum discontinuity of some kind by 1908 as an early "quantum revolution" in its own right. Although the detailed results brought forward by Kuhn's revisionist account have meanwhile found their way into the historical literature on the quantum theory and have, even though with some modifications, to a considerable degree been accepted by other historians of science, his attempt to interpret the early history of the quantum on the background of a theory of scientific revolutions has largely been forgotten. In this paper, we will return to the theoretical ambitions of Kuhn's case study and

³³ Kuhn 1978.

³⁴ Kuhn 1970, first published in 1962.

³⁵ Kuhn 1982 and Kuhn 1984, where he states in particular: "I have generally been well satisfied by the extent to which my narrative fit the developmental schema that *Structure* provides. *Black-body* Theory is no exception."

attempt to make them fruitful for our own analysis of the emergence of the quantum discontinuity, with regard both to its historical reconstruction and to its implications for a historical epistemology of scientific revolutions.

Kuhn's account of the early quantum revolution as it presents itself when set into the framework of his theory may be summarized as follows: The search, since the middle of the 19th century, for the spectrum of heat radiation in thermal equilibrium would have to be qualified, according to Kuhn as "normal science." In 1900, this period of normal science culminated in the establishment of the radiation spectrum by precision measurements and its description by Planck's formula. In the Kuhnian scheme this result corresponds to an anomaly and hence represents the starting point of a crisis of classical physics. In fact, Planck's attempt to derive his radiation formula on the basis of classical physics involved, according to Kuhn, an error. The law itself turned out to be actually incompatible with classical physics. Its rederivation by Einstein and Ehrenfest in 1906 from the assumption of the quantization of energy amounts to a scientific revolution; this revolution essentially ended the crisis by establishing a new paradigm. The new paradigm was, however, not immediately recognized as the solution of the problem, a delay that was essentially due to the marginal position of both Einstein and Ehrenfest in the contemporary physics community. Only an authoritative lecture by the recognized master of classical physics, H.A. Lorentz, in 1908 cleared, according to Kuhn, the way for the widespread acceptance of the new paradigm.

In later commentaries Kuhn emphasizes that this development displays a number of features which he considers to be general characteristics of scientific revolutions. First of all, the change of paradigm is a sudden and total turnover which eludes further analysis. Einstein's discovery of the error in Planck's classical derivation immediately led to the establishment of a quantum derivation of the radiation law. Second and third, this paradigm shift changed both the conception of the objects of physical research and the language to designate them. According to Kuhn, Planck's classical "resonators," producing the thermal equilibrium of heat radiation and sharing many properties with Boltzmann's molecules, thus turned into non-classical "oscillators," capable of exhibiting quantum properties.³⁶

³⁶ Kuhn 1982, pp 25-32; Kuhn 1984, pp 243-245.

THE RECEPTION OF KUHN'S THEORY

Even without going into the details of Kuhn's account and only situating it in the overall history of quantum theory, it is rather obvious that there are problems with it. There is, for instance, little evidence for claiming that the period between 1900 and 1906 was actually a "crisis" of classical physics due to the introduction of a new radiation formula, and even less evidence for the claim that this crisis was essentially terminated in 1906. In the first decennium of the 20th century, physicists rather became only gradually aware that a crisis was imminent. The Solvay conference of 1911 was in fact the first international meeting in which it was widely acknowledged that Planck's formula implies the necessity of at least a partial revision of the foundations of classical physics.³⁷ It thus seems that, in this case, the crisis actually seems to follow rather than to precede the early quantum revolution.

Surprisingly, with a few exceptions, in the lively but short-lived discussion triggered by the publication of Kuhn's study, such issues concerning the structure of the quantum revolution have only played a minor role.³⁸ Many of the reviews written at the time hardly conceal a certain relief that, apparently, even Kuhn himself was no longer taking so seriously his approach since he had in fact renounced his own terminology. It therefore seemed legitimate to continue with or pass on to other research agendas, be they that of historicist, rational or social reconstruction. One prominent and, as far as physicists are concerned, rather influential participant in this discussion, the late Swiss theoretical physicist Res Jost, even prided himself of never having read and never being willing to read Kuhn's *Structure of Scientific Revolutions*.³⁹

In the twenty years that have since passed, numerous studies of the emergence of quantum theory have appeared that have incorporated and further developed specific results of Kuhn's detailed historical analysis.⁴⁰ At the same time, his attempt to analyze the quantum revolution on the background of a general *theory* of the historical development of scientific knowledge has largely fallen into oblivion.

³⁷ See the discussion of Barkan in Beller, Cohen, and Renn 1993.

³⁸ Milestones in this debate are Klein, Shimony, and Pinch 1979; Galison 1981; Jost 1995.

³⁹ Jost 1995, p 67: "*Ich* kann darüber keine Auskunft geben, denn ich werde das Werk [The Structure of Scientific Revolutions] nie gelesen haben werden [sic]."

⁴⁰ See Needell 1980; Darrigol 1991 and Darrigol 1992. For earlier contributions presenting a detailed analysis of the early quantum theory, see especially the numerous papers by Klein and, in particular, Klein 1970.

BACK TO KUHN'S QUESTIONS

In our view, none of the approaches to the history of quantum theory that have meanwhile been pursued has, however, simply superseded the general questions which Kuhn's work has raised and for which his study of the quantum revolution has provided only answers that evidently do not quite fit his own general scheme. Such questions are:

- What accounts for the breaks in the development of scientific knowledge which Kuhn describes as scientific revolutions?
- Is there a continuous growth of knowledge in spite of such breaks?
- Where and when do scientific revolutions occur?

We believe that these questions still provide a useful guidance for an analysis of the quantum revolution and, in particular, of what, according to Kuhn, was a crucial turning point of that revolution, Einstein's demonstration of the non-classical character of Planck's radiation formula. The analysis given here is based on recent scholarship and, in particular, on the substantial contributions by Olivier Darrigol. Our revision of Kuhn's revisionist account suggests that it makes sense to further pursue such thorough and fine-grained studies with the aim to answer such questions. But, as you will see, our reexamination of Kuhn's case study also suggests that the impact of Einstein's interpretation of Planck's results on the development of quantum theory becomes understandable only if it is analyzed in the context of a long-range process in the integration and disintegration of knowledge that cannot be adequately described in the framework of Kuhn's theory.

EINSTEIN'S DISINTEGRATION OF CLASSICAL PHYSICS

PLANCK'S RESONATORS IN CONTEXT

It is rather difficult to disentangle Einstein's role in the development of quantum theory from the later history of that theory, in particular from Einstein's critique of quantum mechanics, including his debate with Bohr.⁴¹ Einstein, as far as his contributions to the early history of quan-

⁴¹ For a recent account, see Beller 1992.

tum theory are concerned, is mostly remembered as an early advocate of the wave-particle duality, as the revolutionary proponent of light quanta, and as a resourceful inventor of applications of the quantum idea with empirical consequences such as the photoelectric effect. Thomas Kuhn, on the other hand, has identified Einstein's critical analysis of Planck's radiation formula as the breakthrough of the early quantum revolution. Here we will follow Kuhn in focussing on this central knot of the story. However, since, according to Kuhn's theory, such a breakthrough comes in the form of a "Gestalt"-switch, it is only natural that he limited himself to describing and analyzing what he perceived as the surfacing of the new paradigm in Einstein's approach to black body theory—without searching for the structure of this emergence. In fact, when zooming in on the heart of a Kuhnian revolution, it turns out that it has no structure.

At the time Kuhn was writing his book, there were, apart from Einstein's papers of 1904, 1905, and 1906, mentioning black body radiation, and from his correspondence, mostly from a later period, hardly any sources available on the basis of which a development of his thinking on this subject could have been traced. Meanwhile, new sources have been identified by the *Collected Papers of Albert Einstein*. Einstein's letters to Mileva Marić from around 1900 make it possible to recognize that his thinking on black body radiation did not come out of nowhere, as Kuhn's account suggests, but emerged from his early reception of Planck. Research notes from the time of Einstein's seemingly conclusive resumé at the 1911 Solvay conference document his relentless examination of the relation between Planck's radiation law and classical physics and show that, for him, the nature of this relation was then still not settled, in contrast to Kuhn's claim. We can therefore now take a closer look at Einstein's reinterpretation of Planck's radiation law, representing for Kuhn the heart of the early quantum revolution, and thus attempt to understand its structure. Here we can only provide a coarse-grained survey, ranging from Einstein's tentative engagement with Planck's theory as a student reading physics journals in his spare time to his massive rejection of this theory as a prominent participant at the Solvay conference.

Between March 1899 and July 1901 Einstein wrote about ten letters to Mileva Marić, not only documenting his close reading of Planck's papers but also his attempts to establish links between black body theory and other areas of physics. These letters display so many of the themes and ideas from Einstein's later quantum papers that one may be tempted to revise, following Kuhn's own criteria, his revision of the dating of the quantum revolution once more and to date it back again to about 1900.

For instance, in March 1901, Einstein thinks of a connection between the specific heats of solid bodies and their absorption spectra, based on the idea that Planck's electromagnetic resonators represent the atomistic constituents of matter and are responsible both for their thermal and their

optical properties.⁴² The very same model of matter would be at the heart of Einstein's revolutionary quantum theory of specific heats, published in 1907. In April 1901, Einstein criticized Planck because he had doubts that, in the case of heat radiation, the equipartition of energy, characteristic for the state of thermal equilibrium, could be achieved by Planck's resonators.⁴³ Precisely the question of how the equipartition of energy was to be applied to heat radiation would become a key subject of Einstein's later quantum papers. In May 1901, Einstein encountered Lenard's experiments on the photoelectric effect, a challenge which he included in his ponderings on the nature of radiation.⁴⁴ The interpretation of this effect by an atomistic theory of light was the key idea of his 1905 paper that would later earn him the Nobel prize.

Even before Einstein's encounter with Lenard's measurements, he had considered the inverse effect of a direct transformation of kinetic energy into light. In fact, Einstein had developed ideas on the nature of radiation that suggested a close relation between the constitution of the energy of radiation and the constitution of the internal energy of matter. He took, in particular, what he saw as the parallelism between the energy distribution among the molecules of a gas and the blackbody spectrum at a given temperature as evidence for this close relation and even for the possibility of a physical exchange between the two forms of energy.⁴⁵ This parallelism, manifesting itself for Einstein in the similarity of the radiation spectrum with the Maxwell-Boltzmann distribution, suggests to conceive heat radiation in analogy to the kinetic conception of a gas as a collection of light atoms. Indeed, on the basis of such an assumption a black body radiation law follows immediately, namely that given by Wien's formula which was in good agreement with contemporary measurements. It could thus have been Einstein's focus on Wien's formula, if not the direct influence of Wien, who had also attempted to relate the problem of heat radiation to the distribution of molecular velocities in a gas, albeit in a different way, that paved the way for Einstein's formulation of the light quantum hypothesis, as one of us has suggested many years ago.⁴⁶ In any case, in Einstein's 1905 paper the relation between Wien's

⁴² Einstein to Mileva Marić, 23 March 1901, Einstein 1987, Doc. 93: "Es scheint mir nämlich nicht ausgeschlossen, daß die latente kinetische Energie der Wärme in festen Körpern und Flüssigkeiten als elektrische Resonatorenenergie auffaßbar sei."

⁴³ Einstein to Mileva Marić, 10 April 1901, Einstein 1987, Doc. 97: "Was mich gegen Plancks Betrachtung über die Natur der Strahlung einnimmt, ist leicht gesagt. Planck nimmt an, daß eine ganz bestimmte Art von Resonatoren (bestimmte Periode und Dämpfung) den Umsatz der Energie der Strahlung bedinge, mit welcher Voraussetzung ich mich nicht recht befreunden kann."

⁴⁴ Einstein to Mileva Marić, 28? May 1901, Einstein 1987, Doc. 111.

⁴⁵ Einstein to Mileva Marić, 30 April 1901, Einstein 1987, Doc. 102: "Neulich kam mir die Idee, daß bei der Entstehung des Lichts vielleicht eine direkte Verwandlung von Bewegungsenergie in Licht stattfindet wegen des Parallelismus Lebendige Kraft der Moleküle - absolute Temperatur - Spektrum (Strahlende Raumenergie im Gleichgewichtszustand)."

⁴⁶ Renn 1993, p. 331-332. It was earlier presented as core of a talk entitled "Einstein's Double Discovery of the Light Quantum" at a symposium held in Jerusalem and Tel Aviv 1990 (Beller, Cohen, and Renn 1993) and has now been followed up with a detailed analysis in a recent paper by John Stachel (Stachel in press).

formula and light quanta is used as an argument for the corpuscular nature of light, exploiting the converging of Planck's distribution with Wien's law for the case of high frequencies and low temperatures.⁴⁷

Was the only reason why this flow of revolutionary ideas did not initiate the early quantum revolution the fact that Einstein did not publish his insights but confided them only to his fiancé Mileva? It seems not since these ideas had, at the time, evidently an epistemic status different from that which they assumed after 1905, as becomes clear from their role in Einstein's early thinking. In fact, Einstein was, at that time, readily prepared to change or give up these ideas either because he realized that they conflicted with available evidence or simply because other ideas were more attractive to him.⁴⁸ For instance, the incorporation of Planck's resonator model into a theory of specific heat was merely a playful idea and not conceived as a rupture with classical physics as it would be the case when Einstein repropounded this idea in 1907, using it to explain the anomalous behavior of specific heats.⁴⁹ Even Einstein's early critique of Planck's use of resonators for distributing the energy over different frequencies in order to generate the thermal equilibrium of heat radiation was not yet intended to question the compatibility of Planck's theory with classical physics.

What accounts for the difference in epistemic status between Einstein's ideas of 1901 and their reappearance in the quantum revolution? While Einstein had cast a wide net of inferences, linking heat radiation with several different knowledge areas, this net was not yet rigid and tight enough as to establish the incompatibility between Planck's radiation law and classical physics. The explanation of the characteristics of heat radiation by an atomistic theory of light, for instance, could at this point be no more than a speculative interpretation becoming obsolete as soon as a classical explanation of these characteristics turned out to be possible.

The above considerations of the epistemic status of Einstein's early ponderings on the nature of radiation hold, *mutatis mutandis*, also for the status of Planck's radiation law in the period immediately following its formulation. Below we will argue that the question of its classical or non-classical character simply could not be settled as long as it remained in "epistemic isolation." In other words, as long as it had not been thoroughly explored how the new results on heat radiation could be integrated into the available physical knowledge, it must have been unclear whether or not Planck's radiation law transcended the limits of classical physics.

⁴⁷ Einstein 1905b (Einstein 1989, Doc. 14).

⁴⁸ See e.g. Einstein to Mileva Marić, second half of May 1901, Einstein 1987, Doc. 110.

⁴⁹ Einstein 1907 (Einstein 1989, Doc. 38).

What does it mean in this case to integrate a new law into the canon of established knowledge? An explanation of heat radiation on the basis of a statistical thermodynamics requires a rule for distributing energy within the radiation field in thermal equilibrium. Such a rule, linking the knowledge area of electrodynamics with that of thermodynamics, was, however, at the time of Einstein's first encounter with Planck, not established as part of the canon of classical physics. It was precisely this missing link which Planck attempted to provide with his resonators to which he adapted Boltzmann's counting of complexions.⁵⁰ But as long as it was not firmly established what the classical solution to the problem of the radiation formula would be, it was simply impossible to decide whether or not Planck's link implied a break with classical physics.

We therefore claim that the question of whether Planck stepped beyond the limits of classical physics, which lies in the center of the discussion provoked by Kuhn's revisionist account, is actually not well posed. Even if Planck would have pronounced himself more explicitly on the matter or would have proceeded more carefully in adapting Boltzmann's approach to his purpose,⁵¹ that question could not have been settled as long as his radiation law was not more closely interwoven with the fabric of classical physics.

In contrast to Planck, the Einstein of 1901 considered the application of statistical methods to radiation as part of a larger problem, of which he became aware when pursuing various questions of the atomistic constitution of matter and radiation.⁵² He was not only looking, as Planck did, for a specific link between Boltzmann's techniques and the problem of heat radiation but he perceived a systematic gap in the available methods of statistical physics, which, in his view, were not general enough to be applied to problems beyond those of the kinetic theory of gases, such as radiation.⁵³ His early letters show in fact that his work on a general theory of statistical mechanics was stimulated by a reflection on this gap. Einstein's statistical mechanics therefore turns out to be shaped by his early reception of Planck and was not, as Kuhn suggested on the basis of the evidence he then had available,⁵⁴ the independent starting point of a new route to black-body theory, culminating in the non-classical derivation of the black-body radiation law, the new paradigm.

⁵⁰ For an account on the relation between Planck's approach to the problem of heat radiation and Boltzmann's theory, see in particular Kuhn 1978, chapter II and pp 102-110 and Darrigol 1988.

⁵¹ See Galison 1981, p 82.

⁵² See Renn 1993; Renn 1997; Renn and Darrigol in press.

⁵³ For a discussion of Planck's perspective on foundational problems, see Renn, Castagnetti, and Rieger 1999, for a survey of Einstein's early work on statistical physics see the editorial note "Einstein on the foundation of statistical physics" in Einstein 1989, 41-55.

⁵⁴ See Kuhn 1978, pp 170-171.

As we will show now, the crucial point of the early quantum revolution was indeed not a non-classical interpretation of Planck's law. On the contrary, it was the integration of the law into classical physics and the revelation of contradictions generated by this integration that altered its meaning and established its revolutionary character. From this perspective, it becomes understandable why, as was mentioned before, in the case of the early quantum revolution, the crisis seems to follow, rather than to precede, the emergence of the new paradigm, to speak in Kuhnian parlance.

PLANCK'S RESONATORS IN CRISIS

In order to demonstrate how the linking of Planck's radiation law with other knowledge areas of classical physics changed the meaning of this law, we begin by briefly recapitulating the structure of Planck's derivation. For this purpose, we refer to the flow diagram of fig. 1 in which various mental models, physical properties, and knowledge areas of physics are related to each other. The diagram shows how, by relating different models to each other, inferences concerning their physical properties become possible, and also how these inferences rely on and connect different knowledge areas. As we are here mainly interested in such a network of mental models functioning as the background of arguments developed in the early history of quantum theory, we can renounce a discussion of their internal structure. For our purposes, a mental model merely represents a cognitive structure that can be built from the resources of the knowledge socially available at the time and that governs the basic, often only qualitative understanding of a certain domain. Examples of mental models structuring the socially available knowledge of physics at the turn of the century are the model according to which heat can be conceived as the random motion of particles or the model according to which an electrical current can be conceived as the flow of electrically charged particles. It is furthermore relevant to our discussion that mental models can be combined with each other, as, in the cases at hand, one can think of a gas consisting of electrically charged particles. In this way, the integrated or "composite model" becomes the starting point for the integration of knowledge from different domains, here from gas theory and electricity.

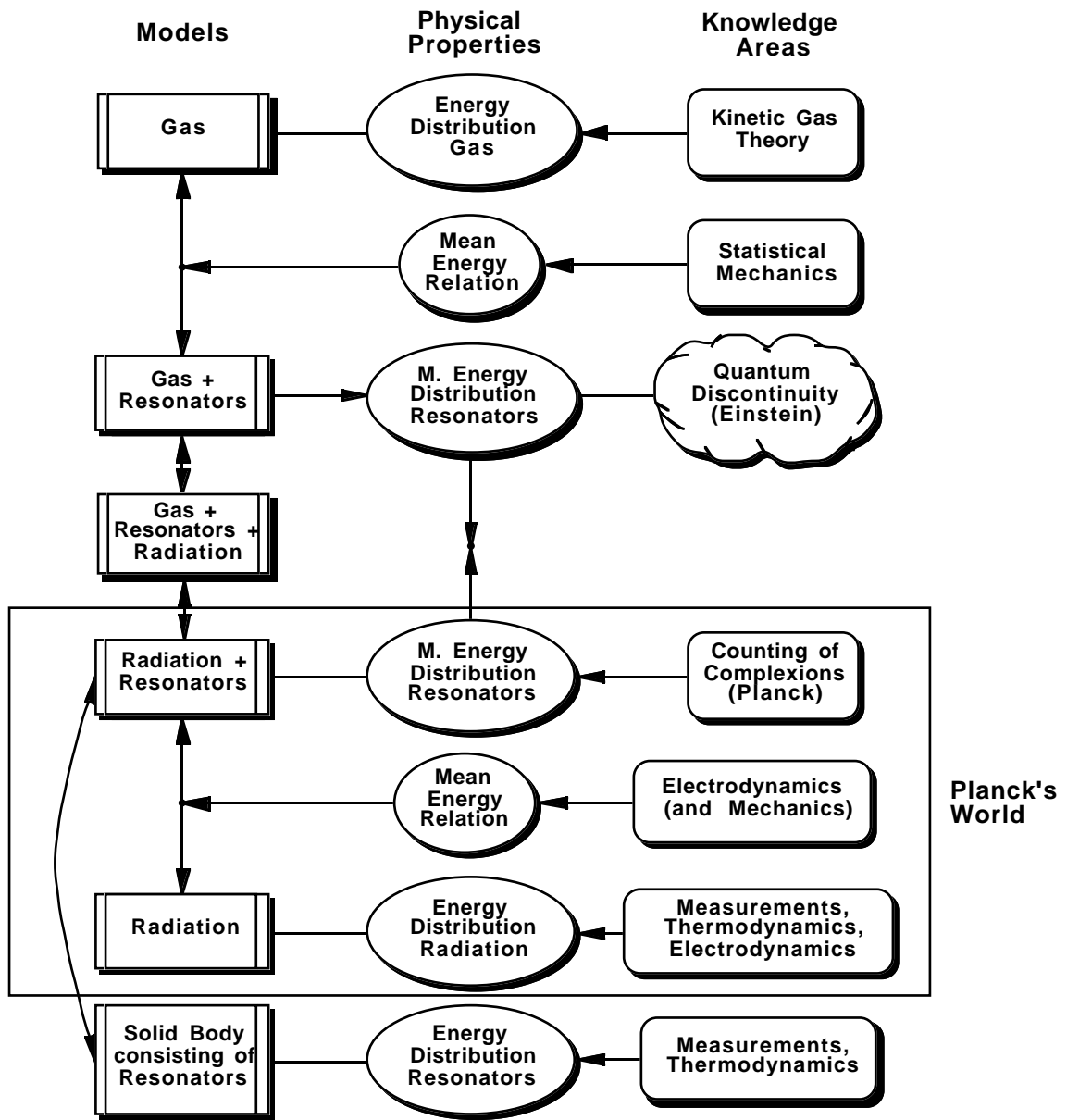

Figure 1: The network of mental models as established by Einstein and others, integrating Planck's radiation law and its derivation into a wider physical context.

Planck's derivations of his radiation law are based on analyzing the general model of heat radiation in thermal equilibrium on the basis of a specific model in which heat radiation is in thermal exchange with what he called resonators.⁵⁵ The lines between different models in our diagram link models to each other which, for the arguments under discussion, can be considered as being equivalent to each other. In this case, Planck's resonators simply represent a specification of the matter that is considered to be in thermal equilibrium with heat radiation. He had good reasons to expect that this specification would not affect the generality of his arguments. A relation derived from electrodynamics made it possible for Planck to relate for a particular frequency the mean energy of the resonators to the mean energy of the radiation.⁵⁶ The precision measurements performed at the PTR, together with laws of heat radiation following from classical physics and implying its independence from specific material properties, had provided the basis for Planck's formulation of his radiation formula, determining the energy spectrum for the general model.⁵⁷ The link between the general and the specific model was his conduit for an interpretation of the radiation spectrum in terms of the mean energy distribution of the resonators. After attempts to derive the latter by purely thermodynamic arguments had failed, Planck resorted to a statistical method taken over from Boltzmann which he adapted in such a way that this mean energy distribution followed. But while the black-body radiation law itself was firmly rooted in precision measurements combined with laws of classical physics, and while the relation between the mean energies of radiation and resonators was equally firmly grounded in classical physics, Planck's statistical arguments could not be anchored in an equally well established knowledge area of classical physics.

Now, what could be done in order to assimilate the statistical behavior of the resonators to the available knowledge of classical physics in the absence of a canonical domain concerned with such behavior? Einstein reacted to this problem by developing, in his early quantum papers, a network of mental models which provides the resonators with physical meaning. This was achieved by incorporating, at the same time, resonators and other physical entities into these models and thereby relating Planck's resonators to various domains of classical physics.

⁵⁵ Even though there are major differences in the technical details of the two derivations given by Planck in 1900 (Planck 1900e) and 1901 (Planck 1901a) (as discussed by Michel Janssen in his talk at the Boston Colloquium, 3 May 2000) they can, for our purposes, be considered to be equivalent.

⁵⁶ This relation presents one of the major achievements of a research program taken up in 1895 by Max Planck. The program culminated in a series of five memoirs entitled "Über irreversible Strahlungsvorgänge" (Planck 1897a; Planck 1897b; Planck 1897c; Planck 1898; Planck 1899; Planck 1900).

⁵⁷ Kuhn has shown how Planck, working backwards from the radiation formula he had introduced to account for the new experimental results (Planck 1900c), could have arrived at an expression for the entropy that then provides the starting point for the statistical interpretations of the 1900 and 1901 papers (Kuhn 1978, pp 97-102).

In particular, Einstein introduced a composite model in which resonators and radiation are combined with a gas.⁵⁸ For such a model there must exist a state of thermodynamic equilibrium. In this state the energy distributions for the single components must be the same as they would be if they were separate from each other, since otherwise a flow of energy from one component to the other would follow. Therefore, it becomes possible to draw conclusions on the statistical behavior of one component from knowledge about the other. For instance, using the knowledge about the energy distribution of the gas molecules, given by kinetic gas theory, the mean energy of the resonators can be inferred. In fact, assuming that the resonators behave like mechanical systems, it follows from statistical mechanics that their mean energy must be the same as that of the gas molecules determined by the equipartition theorem of gas theory. At this point, the network of models gives rise to a clash between two inference paths that cross. The mean energy of the resonators turns out to be independent of frequency, a result that conflicts with the frequency-dependent mean energy distribution following from Planck's radiation law.

It turns out, moreover, that Einstein's network allows to derive a radiation formula which, in contrast to Planck's, can be unproblematically anchored in classical physics. In fact, using the energy distribution following from gas theory, a radiation law, today known as the Rayleigh-Jeans law, could easily be obtained along the lines of Planck's reasoning, as Einstein showed in his 1905 paper. In comparison with Planck's derivation of his own law, this derivation is now no longer shaky because the problematic knowledge area involved in Planck's derivation, Boltzmann's complexion counting, has been replaced by a firm foundation in classical physics, the kinetic theory of gas. But, as it turned out, the resulting radiation law was not only in conflict with the precision measurements of black-body radiation but did not even make sense as a description of a state of thermal equilibrium.

So, what had been accomplished for the understanding of Planck's law by Einstein's attempt to overcome its epistemic isolation by embedding Planck's original model in a network of models and thus loading it with physical content? In a process of normal growth of scientific knowl-

⁵⁸ When Einstein first published his composite model in 1905, he explained it at length: "In einem von vollkommen reflektierenden Wänden eingeschlossenen Raumes [sic] befindet sich eine Anzahl Gasmoleküle und Elektronen, welche frei beweglich sind und aufeinander konservative Kräfte ausüben, wenn sie einander sehr nahe kommen, d.h. miteinander wie Gasmoleküle nach der kinetischen Gastheorie zusammenstoßen können." Here an important footnote is added: "Diese Annahme ist gleichbedeutend mit der Voraussetzung, daß die mittleren kinetischen Energien von Gasmolekülen und Elektronen bei Temperaturgleichgewicht einander gleich seien. [...]" Einstein continues by introducing his model of a resonator: "Eine Anzahl Elektronen sei ferner an voneinander weit entfernte Punkte des Raumes gekettet durch nach diesen Punkten gerichtete, den Elongationen proportionale Kräfte. Auch diese Elektronen sollen mit den freien Molekülen und Elektronen in konservative Wechselwirkung treten, wenn ihnen letztere sehr nahe kommen. Wir nennen die an Raumpunkte geketteten Elektronen "Resonatoren"; sie senden elektromagnetische Wellen bestimmter Periode aus und absorbieren solche." After having given an expression for the mean energy of the resonators in the two separated systems, one containing gas and resonators the other radiation and resonators, he claims that these energies have to be equal if: "die Strahlungsenergie von der Frequenz ν nicht beständig im Ganzen weder vermindert noch vermehrt werden [soll]" that is, if thermodynamic equilibrium holds. See Einstein 1905b (Einstein 1989, Doc.14).

edge, one would expect that a network like that developed by Einstein should make it possible to integrate a new insight smoothly into the established body of knowledge and thus to clarify its meaning in the light of the structure of this knowledge. In this case, however, the smooth integration failed. But still, the embedding of the new radiation law in a wider physical context yielded a clarification of its meaning, namely the recognition of the precise way in which it is in conflict with specific tenets of classical physics. As long as this clarification had not taken place, a break with classical physics had actually not occurred and, consequently, there was no substance for a crisis.

The substance for a crisis was still rather small even after Einstein had localized the conflict of the black-body radiation law with classical physics in the behavior of Planck's resonators. In fact, Planck's resonators largely remained, even after Einstein's analysis, in epistemic isolation. True, it had become clear that the resonators in equilibrium with radiation did not behave according to classical physics and that the energy exchange mediated by these resonators had to exhibit some discontinuity. This insight was, according to Kuhn, the core of the early quantum revolution. But what actually had been quantized remained rather unclear. Due to the unspecific nature of the resonators that was an open question. In the historical situation, it was, in particular, open whether the non-classical behavior of resonators was merely a not yet sufficiently explored effect of matter in interaction with black-body radiation or whether it demanded a revision of the entire foundations of classical physics. In the light of the knowledge available in the first decennium after the formulation of Planck's law, it was in fact difficult to decide between these alternatives which hence became the subject of heated controversies among contemporary physicists who followed different pathways in their reaction to the challenge represented by this law. Planck, for instance, preferred to confine the quantum discontinuity to the discrete behavior of resonators and thus attempted to preserve the knowledge of classical electrodynamics as a basis for his theory of heat radiation.⁵⁹

There were, however, hints pointing at a fundamental character of the crisis. For instance, whenever Planck tried to draw a line around the quantum, the confinement turned out to be too restrictive. On the basis of our analysis, we can now understand the reasons for this failure. In fact, the same type of network relating different models by which the conflicts between the radiation law and classical physics had been established prevented such a confinement and propagated the quantum crisis from black-body radiation to other areas of physics. Einstein, for instance, could now take up his innocent play from 1901 with a theory of solid bodies based on Planck's resonators in order to trace further consequences of the quantum discontinuity and to give more physical meaning to Planck's resonators. Just as he had in 1905 considered Planck's

⁵⁹ See e.g. Planck 1906a; Planck 1911.

resonators as parts of a system to which the kinetic gas theory could be applied, he identified them, in 1907, with the microscopic constituents of solid bodies. In this way, he could infer from Planck's radiation law a distribution of the internal energy of a solid body and hence derive a formula for its specific heat which in turn could be confronted with empirical measurements.⁶⁰ These measurements had already yielded puzzling results deviating from classical expectations. But these results achieved a revolutionary character only by their integration into a network of mental models, just as it was the case for the new radiation law.

In the light of this analysis, it is therefore not surprising that it took about a decennium after Planck's derivation of his revolutionary radiation law in 1900 for the quantum crisis to unfold and reach general awareness among the international physics community. From this perspective, the crucial contributions of this period, such as Einstein's specific heat paper of 1907 or Lorentz's Rome lecture of 1908⁶¹, are not, as Kuhn claimed, facets of the promotion of an already established new paradigm, including the conversion even of Planck by 1910⁶². They can rather be recognized as building up, just as Einstein's network of models, a physical context which first created the basis for revealing the contradictions constituting the revolutionary character of Planck's law.

PLANCK'S RADIATION IN CRISIS

For Einstein the interpretation of Planck's law, involved, as we have seen, from the beginning the question of the nature of radiation, in contrast to what was the case for most of his contemporaries. His network of models, however, as we have so far considered it, leaves a loophole precisely at this point since it does not allow to draw inferences on the nature of radiation. In fact, all inferences which it makes possible concerning radiation involve the behavior of resonators and therefore do not allow to disentangle quantum properties of resonators from those of radiation. The network is, in other words, not yet tight enough to probe into the nature of radiation. In 1905, Einstein had already published arguments for a corpuscular structure of radiation.⁶³ But these arguments were less stringent than those for resonators. As plausible as they may have been, they did in fact not involve demonstrating that the alternative assumption, namely that of a continuous nature of light, leads to contradictions. It was, for instance, in the

⁶⁰ Einstein 1907 (Einstein 1989, Doc. 38).

⁶¹ Lorentz 1908.

⁶² See Kuhn 1978, pp 196-202.

⁶³ Einstein 1905b, pp 142-143 (Einstein 1989, Doc. 14).

period here under discussion, still conceivable to account for the photoelectric effect by a theory different from that of Einstein.⁶⁴ This openness stands in contrast to the firm conclusions Einstein had, as we have seen, been able to reach for the behavior of resonators.

If now the resonators of Einstein's composite models could be replaced by another component, then it might be possible to circumvent the "resonator blockade," barring the pathway towards an exploration of the nature of radiation. A composite model that might lend itself to such an exploration was suggested by Einstein's success in exploring the microscopic constitution of matter through his analysis of Brownian motion in solutions. For a probe suspended in a solution it follows from statistical mechanics that, if it is considered as a microscopic constituent of the system, it must have its share of the mean kinetic energy. It can, on the other hand, be considered as a macroscopic object exposed to a friction force, that is, to the dissipation in the surrounding solution. This force, in turn, is, on the average, balanced by the impact of fluctuations due to the microscopic constitution of the solution. From the two elements, average energy and dissipation, it is possible to determine the fluctuations and thus to derive the Brownian behavior of the probe.⁶⁵

It turned out that this dissipation-fluctuation balance could be recovered for an appropriately modified radiation model. In fact, if one replaces the resonators in the composite model containing radiation and gas by a moveable mirror exposed both to the fluctuations of the gas and of the radiation, the Brownian motion of this probe allows for conclusions on the nature of radiation, just as ordinary Brownian motion does with respect to the constitution of a solution. To begin with, the requirement of thermodynamic equilibrium for the composite system entails that the moving mirror must receive its share of the mean kinetic energy. Furthermore, the thermodynamic equilibrium must hold for each component taken separately so that one can just focus on the interaction between mirror and radiation. Considered as a macroscopic object, the mirror suffers friction from radiation pressure which can be determined on the basis of classical electrodynamics; considered as a microscopic object, the mirror is exposed to the fluctuations of the radiation field. In this way, it is possible to determine the fluctuations of the radiation field with the help of the dissipation-fluctuation balance.

⁶⁴ See e.g. the excerpts of discussions following lectures delivered at the 83rd meeting of the Gesellschaft Deutscher Naturforscher und Ärzte, 25 and 27 September 1911 (Einstein 1993b, Doc. 24).

⁶⁵ See the editorial note "Einstein on Brownian motion", in Einstein 1989, pp 206-222, and Einstein's papers on that subject; Einstein 1905a(Einstein 1989, Doc. 16); Einstein 1906 (Einstein 1989, Doc. 32); Einstein 1908 (Einstein 1989, Doc. 50).

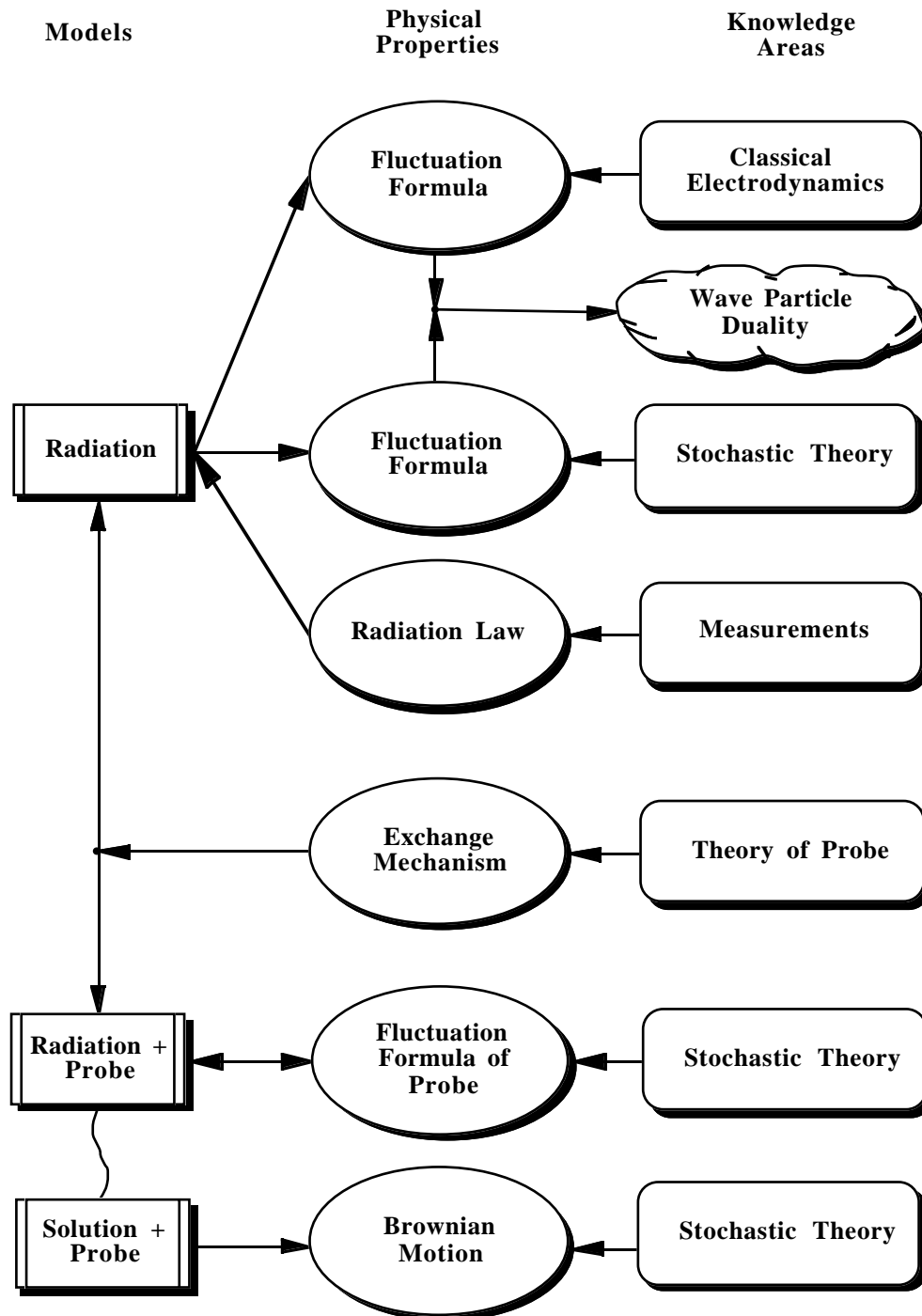

Figure 2: Einstein’s network of mental models that allowed him to expand the quantum problem to the domain of electrodynamics by exploiting an analogy with his treatment of Brownian motion.

In the case of the mirror in a radiation field, the fluctuations can actually be found in two ways, yielding conflicting results. On the one hand, an expression for the fluctuations follows from the above argument if the radiation field satisfies Planck's law determining the dissipation due to the radiation field. On the other hand, a different expression for the fluctuations follows from the interferences occurring in a classical radiation field. Taken together, these two conflicting fluctuation expressions show that Planck's law is not compatible with a radiation field obeying the laws of classical electrodynamics. The mirror model thus allows to carry the quantum conflict directly into the domain of electromagnetic radiation theory, circumventing the resonator blockade.

Did this model actually fix the hole in Einstein's net and definitely capture the non-classical nature of radiation? Which traces did this model leave in the early history of the quantum discontinuity? From later recollections it appears that Einstein had conceived the mirror model as early as 1905.⁶⁶ At that time, a theory of stochastic processes such as it was initiated by his own work on Brownian motion, was, however, only in its infancy. Even when he published it in 1909, this theory was not yet part of a well established domain of knowledge, so that Einstein's pursuit of this line of reasoning remained a rather isolated endeavor.⁶⁷ But apart from the delicate status of Einstein's statistical arguments, there remained a principal epistemic weakness. Just as we have seen in the case of the resonator, arguments on radiation depending just on one specific component of a model involving radiation leave doubts as to whether the non-classical character is to be attributed to that component or to the radiation field itself. Such doubts were indeed expressed in the contemporary discussion.⁶⁸ These doubts could be addressed only by extending the network of models and hence the areas of physics involved in establishing the non-classical character of radiation. It thus becomes understandable why it was so difficult for contemporary physicists to realize whether or not the quantum crisis concerned the nature of radiation. It also becomes understandable why Einstein restlessly searched for further models strengthening the conflict between a radiation field described by Planck's formula and classical physics.

⁶⁶ See Einstein 1979 and Einstein's remarks in a letter to Max von Laue, 17 January 1952, Albert Einstein Archives, 16-168: "Aber 1905 wusste ich schon sicher, dass sie [die Maxwell'sche Theorie] zu falschen Schwankungen des Strahlungsdruckes fuehrt und damit zu einer unrichtigen Brown'schen Bewegung eines Spiegels in einem Planck'schen Strahlungs-Hohlraum."

⁶⁷ Einstein 1909 (Einstein 1989, Doc. 56).

⁶⁸ See e.g. Planck's remarks in response to a talk presented by Einstein on 21 September 1909 at the 81st meeting of the Gesellschaft Deutsche Naturforscher und Ärzte in Salzburg (Einstein 1989, Doc. 61).

An example is found in a hitherto unpublished part of Einstein's so-called Zurich notebook. It is part of a series of considerations related to the quantum problem, which can be dated to a period preceding the 1911 Solvay conference and probably to the time around Einstein's visit to Leiden in February of this year.⁶⁹ On pages 1R and L Einstein considers the model of an absorber in a radiation field, a model to which he later gave a prominent place in his talk at the Solvay conference. He probably developed this model as a response to a criticism of his mirror model by Planck who had argued that the best explanation of reflection at hand involves absorption and emission and hence, as a matter of fact, again the concept of resonators.⁷⁰ By modifying and, at the same time, minimizing the physical assumptions involved, this model made it possible to arrive at conclusions concerning the fluctuations of heat radiation equivalent to those obtained by the mirror model. The place of the kinetic energy of the mirror is here taken by the internal energy of the absorber, while the macroscopic effect of friction due to radiation pressure is here simply replaced by the cooling or heating of the absorber due to the surrounding radiation. This model had thus the advantage of capturing the fluctuations of the radiation field without introducing problematic intermediary processes such as the radiation pressure acting on a mirror. But in spite of its simpler structure, Einstein discussed at great length possible objections to the conclusions about the radiation field drawn from it, even taking into consideration ruptures with classical physics other than that due to a non-classical nature of the radiation field.⁷¹

⁶⁹ Considerations concerning a pendulum of varying length that can be found on p. 4L of the notebook are mentioned in the Solvay discussion (Einstein 1993b, Doc. 26, p 561) as the subject of a conversation between Lorentz and Einstein, probably during a visit to Leiden in early 1911. Notes for a lecture on fluctuations on 10 February 1911 suggest, that this lecture was planned to cover temperature fluctuations of a body immersed in heat radiation as well as the Brownian mirror immersed in heat radiation (Einstein 1993b, Doc. 19). A letter to Lorentz, 15 February 1911 (Einstein 1993a, Doc. 254), contains further clues for dating these notes, among the earliest entries in Einstein's Zurich notebook, to this period.

⁷⁰ See Planck's critique of Einstein's use of the radiation pressure in his argument (Einstein 1989, Doc. 61). As mentioned above Planck admits the necessity of the introduction of certain quanta (*gewisse Quanten*) but raises the question where to search for them. He criticizes Einstein for his introduction of a corpuscular structure of light, a step that, according to his opinion, is not yet necessary. He goes on to explain that Einstein's inference is not conclusive because the interaction of radiation and matter is not fully understood: "Dieser Schluß scheint mir nur dann ganz einwurfsfrei, wenn man die Wechselwirkung zwischen der Strahlung im Vakuum und der Bewegung der Materie vollständig kennt. [...] Sie beruht im wesentlichen auf der Emission und Absorption des Lichtes. Auch der Strahlungsdruck besteht im wesentlichen darin, wenigstens nach der allgemein als gültig angenommenen Dispersionstheorie, welche auch die Reflexion auf Absorption und Emission zurückführt. Nun ist gerade die Emission und die Absorption der dunkle Punkt. [...] An diesem Punkt kann, glaube ich, mit Nutzen die Quantentheorie einsetzen."

⁷¹ In a letter to Laub, 4 November 1910 (Einstein 1993a, Doc. 231), Einstein writes: "Gegenwärtig habe ich große Hoffnung, das Strahlungsproblem zu lösen, u. zwar *ohne Lichtquanten*. [...] Auf das Energieprinzip in seiner heutigen Form müsste man verzichten."

There can be no doubt that the principal aim of this argument, as well as the phalanx of related arguments Einstein had accumulated by the time of the Solvay conference, was not to speculate about a future quantum theory but, as we have claimed, to explore the abyss of the quantum crisis. In fact, in conclusion of his presentation of this argument at the Solvay conference Einstein remarked:⁷²

It was here only my intention to show how deeply the difficulties are rooted in which the radiation formula involves us, even if we consider it as something given purely empirically.

THE QUANTUM DISCONTINUITY AS A BORDERLINE PROBLEM OF CLASSICAL PHYSICS

In conclusion, let us return to the questions posed in the beginning and consider some of the implications of our reexamination of what Kuhn sees as the early quantum revolution for the understanding of breaks in the history of science, for the possibility of a transmission of knowledge across such breaks, and for the localization of a scientific revolution in specific historical conditions of the development of knowledge.

According to Kuhn's theory, a sudden "Gestalt"-switch which can usually be ascribed to an individual ends a period of crisis resulting from anomalies and brings about a new paradigm. Here we attempted to show that, in the early history of the quantum discontinuity, breaks with classical physics were rather the result of the gradual and tedious exploration, not only by an individual scientist but by the scientific community, of a network of mental models linking the new radiation law with other areas of physics. Only once this network had reached a stage in which results could be obtained along different inferential pathways so that contradictions could arise was it possible to recognize that Planck's new radiation law demanded a conceptual revision of the foundations of classical physics.

In the process of exploring such a network, which determines the structure of a scientific revolution, the same fundamental cognitive activities are involved as in the process of integration of knowledge, characteristic of what Kuhn calls "normal science," only with a different result, namely the disintegration of knowledge. The fact that the knowledge being integrated or disintegrated is structured by mental models shaping and also surviving, at least in part, its reorganization in a scientific revolution makes it conceivable how knowledge is transmitted over

⁷² Einstein 1914 (Einstein 1993b, Doc. 26): "Es war hier nur meine Absicht, zu zeigen, wie fundamental die Schwierigkeiten wurzeln, in welche uns die Strahlungsformel verwickelt, auch wenn wir sie als etwas rein empirisch Gegebenes ansehen."

longer historical distances and even across conceptual breaks. The basic knowledge about heat radiation, for instance, is embodied in what we have called the general model of heat radiation, making it possible to understand essential properties of the concrete experimental situations suitable to generate radiation in thermal equilibrium. The knowledge embodied in this model is in effect largely indifferent with respect to the conceptualization of heat radiation either in terms of classical or of quantum physics. This example points, at the same time, to the fact that the backbone of the long-term transmission of mental models is the transmission of their material counterparts, such as the technology used to produce cavities with heat radiation in thermal equilibrium.

According to Kuhn, there exists a general scheme characterizing the emergence and development of a scientific revolution, essentially regardless of the where and when. The risks of such an abstraction are revealed by the difficulties of pressing the early history of the quantum discontinuity into this general pattern. In the light of our discussion, the identification of an early quantum revolution turns out to be an artefact. We have shown that a state of general crisis prevails at a time for which Kuhn claims that a stage of normal science has long returned. For him, this stage was hardly of great epistemological interest. Focussing on scientific revolutions one loses, however, sight of the long-range development of knowledge becoming effective through “normal science,” as it is exemplified by the development of the experimental techniques that only made the precision measurements possible on which the formulation of Planck’s radiation law is based.⁷³

Only such long-range developments bring about the accumulation of highly structured knowledge that is the prerequisite for the construction of contradictions determining the where and when of a scientific revolution. It was, in particular, only the emergence of large knowledge blocks with their own conceptual autonomy accumulated in the specialized disciplines of 19th century science that created the precondition for their encounter in borderline problems with revolutionary consequences. Just as the electrodynamics of moving bodies constituted a borderline problem between electrodynamics and mechanics, eventually triggering the relativity revolution, heat radiation represented a borderline problem between thermodynamics and electrodynamics. It could thus become the germ for the integration of different knowledge traditions but also the point at which conceptual conflicts arise between these traditions. In this way, the problem of heat radiation could trigger a crisis of classical physics and eventually become the birthplace of quantum theory.

⁷³ This aspect has in detail been discussed by Dieter Hoffman in his talk at the Boston Colloquium, 3 May 2000, see the next contribution in this collection.

Without an adequate description of the knowledge structures involved in such a transformation it must, however, remain a riddle how the knowledge of classical physics could be exploited to create what Kuhn would call a new paradigm incompatible with it. Here we have suggested that a description of such knowledge structures in terms of mental models makes it possible to understand how the early quantum crisis emerged from the exploration of the limits of classical physics. It seems promising to us to investigate to which extent also the quantum revolution as a whole results from restructuring the knowledge of classical physics.

BIBLIOGRAPHY

- Beller, M. 1992. The Birth of Bohr's Complementarity: The Context and the Dialogues. *Stud.Hist.Phil.Sci.*, 23(1), 147-180.
- Beller, M., R. S. Cohen, and J. Renn (ed.). 1993. *Einstein in Context: A Special Issue of Science in Context*. Cambridge: Cambridge University Press.
- Darrigol, O. 1988. Statistics and Combinations in Early Quantum Theory. In *Historical Studies in the Physical and Biological Sciences*, 17-80. Berkeley: Univ. of California Press.
- Darrigol, O. 1991. Statistics and Combinatorics in Early Quantum Theory, II: Early Symptoma of Indistinguishability and Holism. In *Historical Studies in the Physical and Biological Sciences*, 237-298 Berkeley: Univ. of California Press.
- Darrigol, O. 1992. *From "c"-Numbers to "q"-Numbers: The Classical Analogy in the History of Quantum Theory*. Berkeley: University of California Press.
- Einstein, A. 1905a. Über die von der molekularkinetischen Theorie der Wärme geforderte Bewegung von in ruhenden Flüssigkeiten suspendierten Teilchen. *Annalen der Physik*, 17, 549-560.
- Einstein, A. 1905b. Über einen die Erzeugung und Verwandlung des Lichtes betreffenden heuristischen Gesichtspunkt. *Annalen der Physik*, 17, 132-148.
- Einstein, A. 1906. Zur Theorie der Brownschen Bewegung. *Annalen der Physik*, 19, 371-381.
- Einstein, A. 1907. Die Plancksche Theorie der Strahlung und die Theorie der spezifischen Wärme. *Annalen der Physik*, 22, 180-190.
- Einstein, A. 1908. Elementare Theorie der Brownschen Bewegung. *Zeitschrift für Elektrochemie und angewandte physikalische Chemie*, 14, 235-239.
- Einstein, A. 1909. Zum gegenwärtigen Stand des Strahlungsproblems. *Physikalische Zeitschrift*, 10(6), 185-193.

Einstein, A. 1914. Zum gegenwärtigen Stande des Problems der spezifischen Wärme. In A. Eucken (ed.), *Die Theorie der Strahlung und der Quanten. Verhandlungen auf einer von E. Solvay einberufenen Zusammenkunft (30. Oktober bis 3. November 1911), mit einer Abhandlung über die Entwicklung der Quantentheorie vom Herbst 1911 bis Sommer 1913*, 330-352. Abhandlungen der Deutschen Bunsen Gesellschaft für angewandte physikalische Chemievol. 3. Halle a. S.: Knapp.

Einstein, A. 1979. *Autobiographical Notes* (A. Schilpp, Trans.). La Salle: Open Court.

Einstein, A. 1987. *The Early Years, 1879-1902*. The Collected Papers of Albert Einstein, vol. 1. Princeton: Princeton University Press.

Einstein, A. 1989. *The Swiss Years: Writings, 1900-1909*. The Collected Papers of Albert Einstein, vol. 2. Princeton: Princeton University Press.

Einstein, A. 1993a. *The Swiss Years: Correspondence, 1902-1914*. The Collected Papers of Albert Einstein, vol. 5. Princeton: Princeton Univ. Press.

Einstein, A. 1993b. *The Swiss Years: Writings, 1909-1911*. The Collected Papers of Albert Einstein, vol. 3. Princeton: Princeton University Press.

Galison, P. 1981. Kuhn and the Quantum Controversy. *The British Journal for the Philosophy of Science*, 32(1), 71-85.

Jost, R. 1995. *Das Märchen vom Elfenbeinernen Turm: Reden und Aufsätze*. Lecture Notes in Physics: N.s M, Monographs, vol. 34. Berlin: Springer.

Klein, M. J. (ed.). 1970. *The Making of a Theoretical Physicist*. Paul Ehrenfest, vol. 1. Amsterdam: North Holland Publ.

Klein, M. J., A. Shimony, and T. J. Pinch. 1979. Paradigm Lost ? A Review Symposium. *ISIS*, 70(253), 429-440.

Kuhn, T. S. 1970. *The Structure of Scientific Revolutions* (2. ed.). International Encyclopedia of Unified Science. Chicago: University of Chicago Press.

Kuhn, T. S. 1978. *Black-Body Theory and the Quantum Discontinuity, 1894-1912*. New York: Oxford University Press.

Kuhn, T. S. 1982. *Was sind wissenschaftliche Revolutionen?: 10. Werner-Heisenberg-Vorlesung gehalten in München-Nymphenburg am 24. Febr. 1981*. München-Nymphenburg: Carl-Friedrich-von-Siemens-Stiftung.

Kuhn, T. S. 1984. Revisiting Planck. *HSPS*, 14(2), 232-252.

Lorentz, H. A. 1908. Le partage de l'énergie entre la matière pondérable et l'éther. *Nuovo cimento*, 16, 5-38.

Needell, A. A. 1980 *Irreversibility and the Failure of Classical Dynamics: Max Planck's Work on the Quantum Theory, 1900-1915*. Yale University.

Planck, M. 1897a. Über irreversible Strahlungsvorgänge (Dritte Mitteilung). *Sitzungsberichte der Königlich Preussischen Akademie der Wissenschaften*, 419-422.

Planck, M. 1897b. Über irreversible Strahlungsvorgänge (Erste Mitteilung). *Sitzungsberichte der Königlich Preussischen Akademie der Wissenschaften*, 57-68.

Planck, M. 1897c. Über irreversible Strahlungsvorgänge (Zweite Mitteilung). *Sitzungsberichte der Königlich Preussischen Akademie der Wissenschaften*, 715-717.

Planck, M. 1898. Über irreversible Strahlungsvorgänge (Vierte Mitteilung). *Sitzungsberichte der Königlich Preussischen Akademie der Wissenschaften*, 449-476.

Planck, M. 1899. Über irreversible Strahlungsvorgänge (Fünfte Mitteilung / Schluss). *Sitzungsberichte der Königlich Preussischen Akademie der Wissenschaften*, 25, 440-480.

Planck, M. 1900. Über irreversible Strahlungsvorgänge. *Annalen der Physik*, 1, 69-122.

Planck, M. 1900c. Über eine Verbesserung der Wien'schen Spectralgleichung. *Verhandlungen der Deutschen Physikalischen Gesellschaft*, 2(13), 202-204.

Planck, M. 1900e. Zur Theorie des Gesetzes der Energieverteilung im Normalspectrum. *Verhandlungen der Deutschen Physikalischen Gesellschaft*, 2(17), 237-245.

Planck, M. 1901a. Über das Gesetz der Energieverteilung im Normalspectrum. *Annalen der Physik*, 4(3), 553-563.

Planck, M. 1906a. *Vorlesungen über die Theorie der Wärmestrahlung*. Leipzig: Barth.

Planck, M. 1911. Eine neue Strahlungshypothese. *Verhandlungen der Deutschen Physikalischen Gesellschaft*, 13(3), 138-148.

Renn, J. 1993. Einstein as a Disciple of Galileo: A Comparative Study of Conceptual Development in Physics. *Science in Context*, 6, 311-341.

Renn, J. 1997. *Einstein's Controversy with Drude and the Origin of Statistical Mechanics in his Atomism: A New Glimpse from the "Love Letters"*. Max-Planck-Institut für Wissenschaftsgeschichte; Preprint, vol. 55: Max-Planck-Institut für Wissenschaftsgeschichte.

Renn, J., G. Castagnetti, and S. Rieger. 1999. *Adolf von Harnack und Max Planck*. Max-Planck-Institut für Wissenschaftsgeschichte; Preprint, vol. 113. Berlin: Max-Planck-Institut für Wissenschaftsgeschichte.

Renn, J., and O. Darrigol. in press. Statistical Mechanics. In S. Petruccioli (ed.), *History of Science: The Scientific Revolution*, vol. VI-VII. Rom: Istituto della Enciclopedia Italiana.

Stachel, J. in press. Einstein's Light-Quantum Hypothesis, or Why Didn't Einstein Propose a Quantum Gas a Decade-And-A-Half Earlier? In *The Young Einstein*. Einstein Studies. vol. 8. Boston: Birkhäuser.

ON THE EXPERIMENTAL CONTEXT OF PLANCK'S FOUNDATION OF QUANTUM THEORY

Dieter Hoffmann

INTRODUCTION

One of the great anticlimaxes in all of literature occurs at the end of Shakespeare's Hamlet. On a stage strewn with noble and heroic corpus—Hamlet, Laertes, Claudius, and Gertrude—the ambassadors from England arrive and announce that “Rosencrantz and Guildenstern are dead”. No one cares. A similar reaction might be produced among a group of physicists, or even among historians and philosophers of science, were someone to announce that “Lummer and Pringsheim are dead.”⁷⁴

Allan Franklin's book, “The Neglect of Experiment”, begins with this quotation. Unfortunately the situation has not changed during the last decade—Otto Lummer, Ernst Pringsheim and a lot of other important experimental physicists are still standing in the shadow of such heroes like Planck, Einstein, Bohr, Heisenberg or other theoreticians. Therefore I would like to pick up these figures in my paper. However I shall not give a necrolog of Lummer and Pringsheim, but on the occasion of this year's quantum centenary I will tell a rather different story of the pre-history of quantum theory than you can read in the common literature about this subject. The latter is—as today's history of physics in general—dominated by approaches, which put the theoretical work in the centre and describe Planck's discovery mostly in a highly theoretical context: for instance, discussing Planck's “Akt der Verzweiflung” and the several steps in the derivation of his radiation law or tracing the development of the various radiation laws in general. In contrast to these investigations there are only a few exceptional examples, in which you can learn something more on the experimental framework of the establishment of the radiation theory: first of all, one has to mention Hans Kangro's still fundamental study on the “History of Planck's Radiation Law”⁷⁵ and second, a paper by the Halle historian of physics Rolf Grabow⁷⁶, but later found in the historiography of quantum theory a very little resonance. I will follow the traces of these investigations from the 1970's and focussing on the experimental side of the quantum story. Putting this approach into a more postmodern terminology, one could say, that the paper would like to throw more light on the material culture of the foundation of the

⁷⁴ A. Franklin: *The Neglect Experiment*. Cambridge 1986, S.1.

⁷⁵ H. Kangro: *Early History of Planck's Radiation Law*. London 1976.

⁷⁶ R. Grabow: *Zur Vorgeschichte der Planckschen Strahlungsgleichung*. *Physik in der Schule* 13(1975) 12, 521-528; 14(1976)1/2, 10-16.

quantum theory or in a provocative manner, that the birthplace⁷⁷ of this scientific revolution was not located at the lecturer room of the Physical Institute of Berlin's University, where Planck gave his famous talk on December 14th, 1900, or in Planck's office at the Institute of Theoretical Physics—both places are just located in the centre of Berlin—but five miles away at the Physikalisch-Technische Reichsanstalt (PTR) in Berlin-Charlottenburg (figure 1), in its optics laboratory.

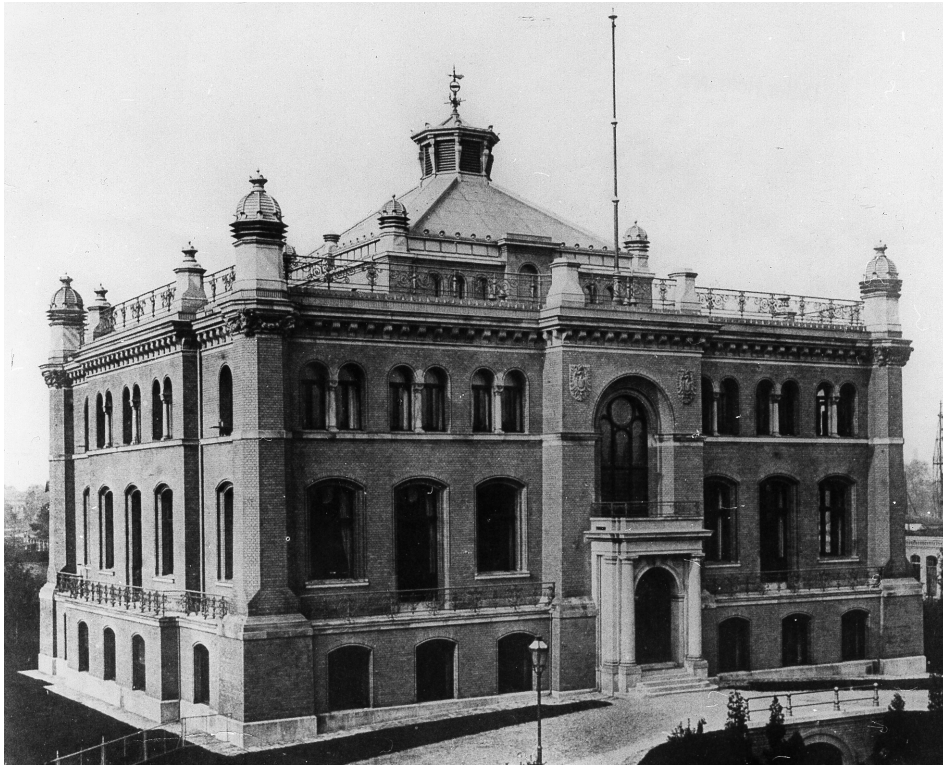

Figure 1: The Observatorium of the Physikalisch-Technische Reichsanstalt in Berlin-Charlottenburg. The black body experiments were carried out in its “clock hall”.

FROM A STANDARD OF LIGHT TO THE FABRICATION OF A BLACK-BODY

The optics Laboratory of the PTR, which is shown on figure 2, had carried out the crucial measurements of the energy distribution of a black body, which disclosed the fundamental discrepancies of the radiation law. The laboratory was part of a culture of precision measurement, which the PTR had cultivated since its foundation. It was also the result of its very successful engagement in the field of radiation research. The latter was embedded into the search for a re-

⁷⁷ A. Sommerfeld characterized in the introduction of his famous book “Atombau und Spektrallinien”. (Leipzig 1919, p.4.) the December 14th, 1900 as the “birthdate of quantum theory”.

liable standard of light. Such a standard was widely sought and employed during the second half of the 19th century, when the gas light became more and more common. The rising of electric lighting and the keen competition between electrical and gas light provided an additional incentive for such developments. Not by chance the PTR became the place where such work was concentrated which had already started shortly after the foundation of the institute in 1887.⁷⁸

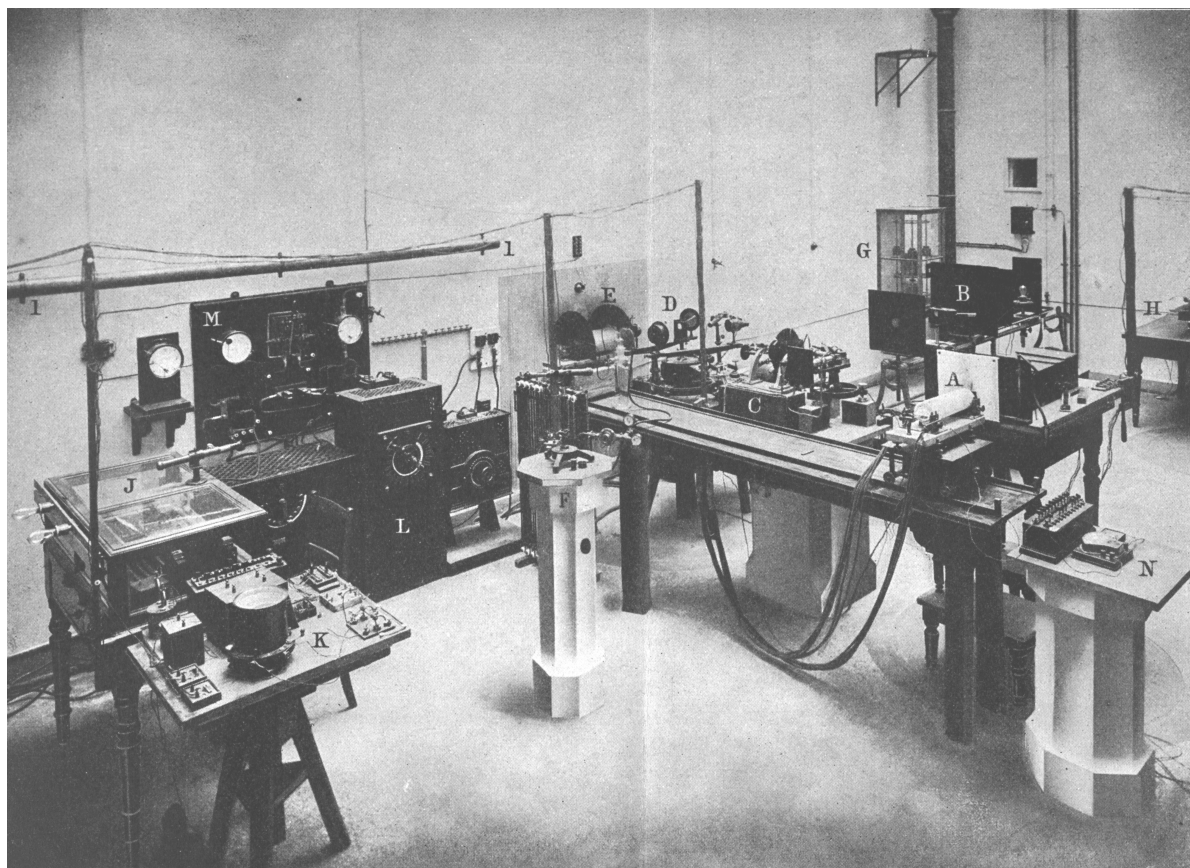

Figure 2: The Optics laboratory with the black body (in front of A), the bolometer (behind A), the spectrolometer (D) and some other instruments of contemporary radiation research.

Already in 1888 the German Association of Gas and Water Craftsmen (Deutscher Verein für Gas- und Wasserfachmänner) approached with the request to PTR's president Hermann von Helmholtz, to evaluate the practical used standards of light and to achieve a general and world-wide accepted unit of luminous intensity. Such standards were not trivial to generate. The accuracy of the oil lamps and candles, which were used as standards until the mid of the 19th century, was poor and so were the methods of investigations. Improved standards were proposed all over the world. For instance in 1884 the Paris' Electrical Congress had already suggested to define the unit of luminosity by the radiation, which is emitted from a melting Platinum plate of 1cm^2 . Although it turned out well to produce a melting "pond" of platinum

⁷⁸ See D. Cahan: *An Institute for an Empire*. Cambridge 1989.

and to keep it on a definite temperature for a long time, this method was not very reliable to establish a practically used light standard—above all the expenses for such a procedure were too high. Instead another practical solution was established during this time with the design of the so called Hefner candle. This candle was an oil lamp burning amyl acetate and provided an usable and relative cheap unit for the luminous intensity—in Germany it was introduced as a standard of light in 1883 and was used as such up to the 1940's. With its foundation the PTR became in charge with the calibration of the Hefner candle. However the Hefner candle did not solve the fundamental problem. Its intensity was conditional on humidity, air pressure and other external variables. Furthermore the calibration of the Hefner candle was only a comparative and therefore the problem remains of an absolute measurement of light and the definition of an absolute unit of light. Therefore the physicists of the PTR—as everywhere in the world—were highly interested “in determining of the absolute quantity of light radiation”.⁷⁹

Otto Lummer, a former student of Helmholtz and one of his most gifted staff member in this field, became the central figure in solving the related problems and in organizing a powerful laboratory for radiation research.⁸⁰ He was a fellow of the PTR from its very beginning in 1887. Already in 1889 he had a name for himself as an innovative researcher in the field of optics, in particular with the design of the so called Lummer-Broduhn contrast photometer.⁸¹ It took the place of the so called “grease-spot” photometer, designed by Robert Bunsen in 1843. The new photometer was an important improvement in photometry as well as for radiation research in general. The sensitivity of the new instrument was twice as much as the old technique and it became one of the most powerful and widely used devices for light measurement. The new instrument tackled the problem of an accurate comparison of different light sources, for instance comparing them to the Hefner candle. But the contemporary light sources such as the incandescent bulb or the gas light radiate more energy in the invisible part of the spectrum as in the visible. Therefore it became a more and more interesting problem to improve the knowledge about this part of the spectrum and to determine the intensity of the radiation of the whole spectrum, too.

⁷⁹ Die Tätigkeit der Physikalisch-Technischen Reichsanstalt in den Jahren 1891 und 1892. *Zeitschrift für Instrumentenkunde* 13(1893) 120.

⁸⁰ S. Nündel, D. Hoffmann: Otto Lummer - ein Experimentalphysiker von Format. *metrologische Abhandlungen* 5(1985)4, 283-294.

⁸¹ O. Lummer, E. Broduhn: Photometrische Untersuchungen. *Zeitschrift für Instrumentenkunde* 9(1899) 41-50.



Ferdinand Kurlbaum
1857 - 1927

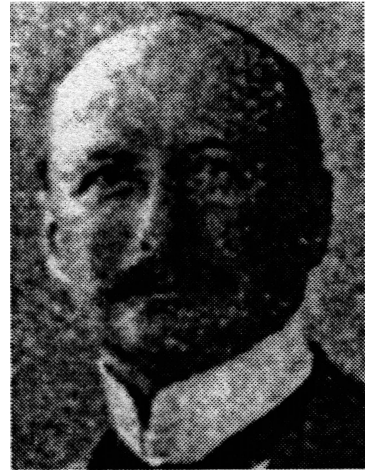

Ernst Pringsheim
1859 - 1917

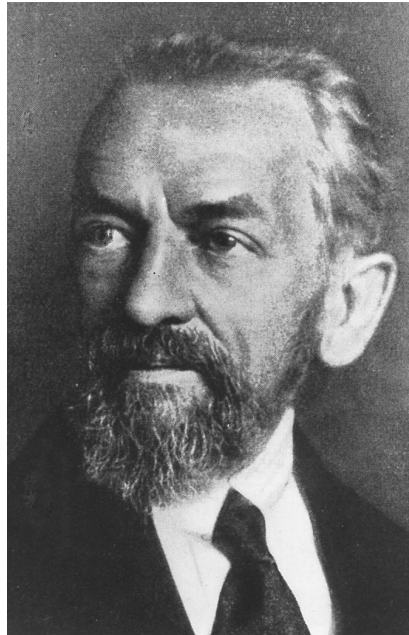

Otto Lummer
1860 - 1925



Heinrich Rubens
1865 - 1922

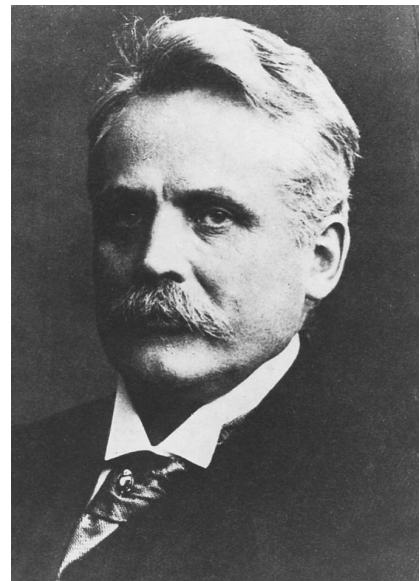

Wilhelm Wien
1864 - 1928

For such a turning of photometry to radiometry it was necessary to improve the techniques of light measurement basically and to know more about the general radiation laws. This was done by Otto Lummer and his colleagues at the PTR in particular. Their research—Lummer worked together Wilhelm Wien first, but he left the institute for a professorship at the TH Aachen already in 1896, and later with Ernst Pringsheim and Ferdinand Kurlbaum (see pictures on previous page)—enabled to examine the fundamental laws of light radiation in earnest during the last decade of the 19th century. Such fundamental radiation laws were already known since decades. First Gustav Robert Kirchhoff has shown in 1859, that “the ratio of power of emission to the power of absorption, e/a , common to all bodies, is a function depending on the wavelength (of the radiation emitted or absorbed) and the temperature”⁸²; 25 years later, in 1884 Ludwig Boltzmann had given a theoretical derivation of a law obtained empirically by Joseph Stefan in 1879, that the total intensity of the radiation emitted by a heated body is proportional to the fourth power of the absolute temperature.⁸³ But the problem of these fundamental laws of light radiation was, that they were only theoretical derivations and their experimental verification was still underway. A crucial precondition of both laws was still unfulfilled, since the heated body had been a “completely black body”. This was already defined in Kirchhoff’s famous paper⁸⁴ as a body, which absorbs all radiation falling upon it. That means $a = 1$ and Kirchhoff’s law becomes:

$$f(T,v) = e/1 = E_{bb}$$

Therefore it was for the experimental verification of these laws central to design such a completely black body, since it does not exist in nature. It was already Kirchhoff, who gave in his famous paper an idea for the technical realization of a black body, when he wrote:

“If a space is surrounded by bodies with the same temperature and rays can not penetrate those, then each ray in the cavity has such a quality and intensity as if it comes from a complete black body of the same temperature”.⁸⁵

⁸² G. Kirchhoff: Abhandlungen über Emission und Absorption. Ostwalds Klassiker, Nr. 100, Leipzig 1900 ... Annalen der Physik (1859) 726.

⁸³ L. Boltzmann: Ableitung des Stefanschen Gesetzes, betreffend die Abhängigkeit der Wärmestrahlung von der Temperatur aus der elektromagnetischen Lichttheorie. Annalen der Physik 22(1884) 291-294.

⁸⁴ G. Kirchhoff: Über das Verhältnis zwischen dem Emissionsvermögen und dem Absorptionsvermögen der Körper für Licht und Wärme, Annalen der Physik 19(1860) 276.

⁸⁵ G. Kirchhoff: Über das Verhältnis... a.a.o., S. 301.

(Wenn ein Raum von Körpern gleicher Temperatur umschlossen ist und durch diese Körper keine Strahlen durchdringen können, so ist ein jedes Strahlenbündel im Innern des Raumes seiner Qualität und Intensität nach gerade so beschaffen, als ob es von einem vollkommen schwarzen Körper derselben Temperatur herkäme, ist also unabhängig von der Beschaffenheit und Gestalt der Körper und nur durch die Temperatur bedingt.)⁸⁶

However the experimentalists did not follow Kirchhoff's idea in performing their investigations for the verification of the radiation laws in the first instance; in general "the problem of the blackness of the bodies and its importance for the radiation"⁸⁷ was more or less neglected (*"die Frage nach der Schwärze der Körper und ihrer Bedeutung für die Strahlung (hat man überhaupt) außer acht gelassen"*). One was satisfied with metal sheets, whose surfaces were prepared with special methods or materials—oxidizing, covering with lamp black, roughen up etc.—to get a maximum of blackness. All these arrangements had shown, that the realization of a black body was managed only for a limited range of wavelength and temperature, but the complete black body was still far away. For instance the Danish physicists Christian Christiansen had already carried out such experiments around 1880 and had tested the emissivity of uneven surfaces and the optical behavior of powders as soot and others.⁸⁸ In connection with these experiments he had made the experience, that conical holes, which were drilled into the so called Leslie cube, radiate with an emissivity of about 1. That means they act as a "small black spots"⁸⁹. Another example were the investigations of the American physicists Charles Edward St. John, who worked not far from his PTR colleagues at the Physical Institute of Berlin's University and were investigating the emissivity of radiating bodies consisting of rare earth. In a paper, published in 1895, he had shown, that the radiation, which is emitted by a heating space of homogenous temperature, shows very similar properties to these of a black body.⁹⁰

(“Die Strahlung, welche von irgend einem Körper in einem gleichförmig temperirten, fest geschlossenen Heizraum herkommt, hat nach Kirchhoff sehr nahe dieselbe Beschaffenheit, als käme sie von einem schwarzen Körper, und kann daher mit grossem Vortheil zu absoluten und relativen Messungen über Strahlung gebraucht werden”.)

But in general the contemporary radiation investigations indicate, that the used radiators were very different from a completely black body yet.

⁸⁶ Since the above quotation is my English translation, I also present in brackets the original German text.

⁸⁷ Müller-Pouillet's Lehrbuch der Physik, Braunschweig 1909, Bd.2/3 (Optik), S.626.

⁸⁸ Ch. Christiansen: Über die Emission der Wärme von unebenen Oberflächen. Annalen der Physik 21(1884)364-369; derselbe: Untersuchungen über die optischen Eigenschaften von fein vertheilten Körpern Annalen der Physik 23(1884)298-306.

⁸⁹ Ch. Christiansen: Über ... a.a.o., S. 367.

⁹⁰ Chas.E.St. John: Über die Vergleichung des Lichtemissionsvermögens der Körper bei hohen Temperaturen, und über den Auer'schen Brenner. Annalen der Physik 56(1895) 450.

The turning point for the design of a complete black body was reached, when Wilhelm Wien and Otto Lummer recognize in 1895, that one “had change from the artificial blacked metal sheets” (*man “überhaupt von den künstlich geschwärzten Blechen absehen muß”*) and instead

“one had to assume the radiation of a black body as the state of a thermodynamical equilibrium...to found on this fact a working method for producing a black body radiation it is necessary to realize a cavity, which was brought to as uniform a temperature as possible, and radiation allowed to pass outwards through an opening”.⁹¹

(und stattdessen “die Strahlung eines schwarzen Körpers als den Zustand des Wärme Gleichgewichts aufzufassen (hat)... Um hierauf auch eine praktisch brauchbare Methode zu gründen, durch die man die Strahlung eines schwarzen Körpers in beliebiger Annäherung herstellen kann, muss man einen Hohlraum auf gleichmässige Temperatur bringen und durch die Öffnung seine Strahlung nach aussen gelangen lassen”.)

Indeed this was the above mentioned idea of Kirchhoff, which one can also find in Boltzmann in his famous publication from 1884.⁹² Although Boltzmann had already made some unsuccessful experiments in this direction, it is a little bit mysterious—not only from the present perspective—that this idea was picked up very late by the experimental physicists. Already Lummer was surprised about this “professional blindness” (*Betriebsblindheit*), when he mentioned later, in 1909:

“It is curious, that in spite of Kirchhoff’s theory of cavity it needs more than 40 years for the experimental realization of the black body radiation. From his deduction to its experimental utilization is it a minute step only, but Kirchhoff himself missed it, although he expected a big progress in this way”.⁹³

(Es ist merkwürdig, daß man trotz der Hohlraumtheorie Kirchhofs fast 40 Jahre gebraucht hat, ehe man zur experimentellen Verwirklichung der schwarzen Strahlung gelangt ist. Denn von dieser Folgerung bis zu ihrer experimentellen Ausnutzung bedeutet es nur einen winzigen Schritt, der freilich selbst Kirchhoff entgangen zu sein scheint, obwohl er von ihm mit Recht einen großen Fortschritt erwartete.)

⁹¹ W. Wien, O. Lummer: Methode zur Prüfung des Strahlungsgesetzes absolut schwarzer Körper. *Annalen der Physik* 56(1895)453.

⁹² L. Boltzmann: Ableitung des Stefanschen Gesetzes..., a.a.o., S.293.

⁹³ Müller-Pouillet's Lehrbuch der Physik, Braunschweig 1909, Bd. 2/3 (Optik), S. 627.

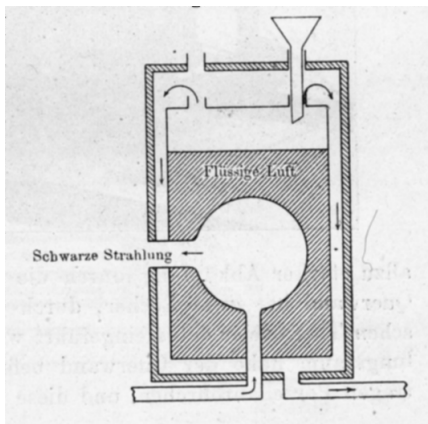

Liquid air

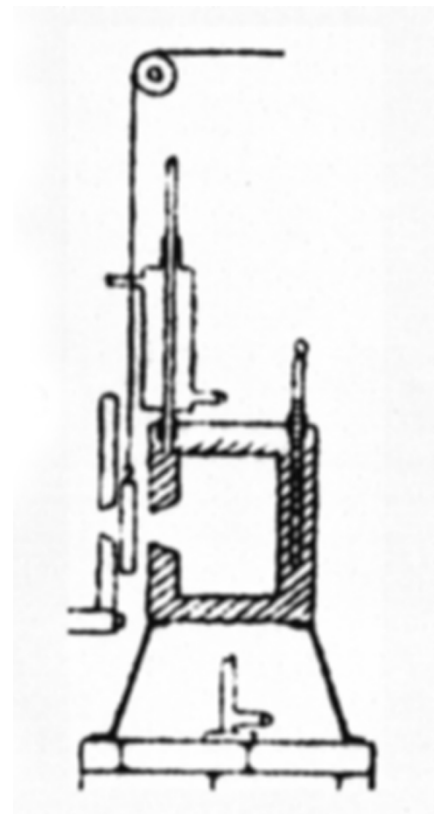

Boiled water

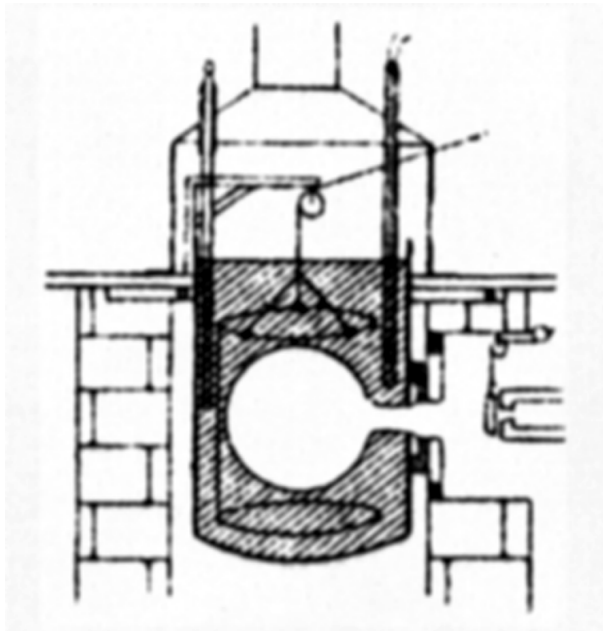

Liquid salpeter

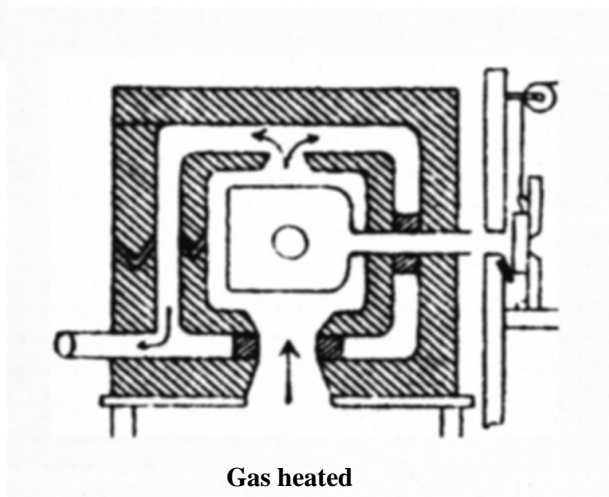

Gas heated

Figure 3: Black body radiators immersed in fluid baths, designed by O. Lummer and E. Pringsheim 1897/98.

The motivation of Wien and Lummer to design a completely black body was not only to check the radiation laws, but also to provide an absolute intensity standard in this way—as one can read in the annual report of the PTR for 1995/96:

“The experiments on black body radiation show good promise to reduce the radiation of a light source to that of a constant heat source”.⁹⁴

(Die Versuche über die Strahlung schwarzer Körper berechtigen zur Hoffnung, jene früher schon ausgesprochene Idee, die Strahlung einer Lichtquelle auf diejenige einer konstanten Wärmequelle zurückzuführen, zu besserem Erfolg führen zu können.)

Although both aims were pursued during the next years, the examination of the radiation laws was placed during these years more and more into the foreground. After Wien and Lummer had given a principal description of the design of a black cavity radiator, Lummer (together with E. Pringsheim in particular) could finish the practical realization of a black body in 1897/98. First they had experimented with small cylindrical and ball shaped cavities of iron and copper, and later they designed double walled spheres of porcelain or metal, whose inner surface was covered with soot (for lower temperatures) or with Uranium oxide (for higher temperatures); for producing an definite and stable temperature the cavities were immersed in fluid baths—for instance liquid air, boiled water, hot salpeter or other temperature well defined liquids. In this way Lummer and Pringsheim could realize a complete black body for a temperature range between -188°C and 700°C , and also for temperatures up to 1200°C , when they placed the cavity into a gas heating chamotte oven (see figure 3).

With these apparatus they carried out first orientating experiments for the comparison of the black body radiation with the platin's light unit as well as for the proof of the Stefan-Boltzmann law. Additionally they could also prove the validity of the Boltzmann law for the above mentioned range of temperature and this was the first proof of the law with precision measurements at all—the estimated error was a few percentage only. Shortly after this important success they proceeded to confirm Wien's law of derivation.⁹⁵ But for extended investigations it had been necessary to design a black body for much higher temperatures. Furthermore the new black body should be also more homogenous in the temperature of the cavity and it should be better manageable than the first one. In 1898 Lummer and Kurlbaum designed the so called “electrical glowing complete black body” (figure 4).

⁹⁴ Die Tätigkeit der Physikalisch-Technischen Reichsanstalt in der Zeit vom 1. April 1895 bis 1. Februar 1896. Zeitschrift für Instrumentenkunde 16(1896) 209.

⁹⁵ Die Tätigkeit der Physikalisch-Technischen Reichsanstalt in der Zeit vom 1. April 1898 bis 1. Februar 1899. Zeitschrift für Instrumentenkunde 19(1899) 214.

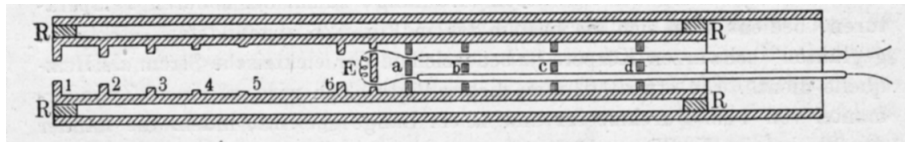
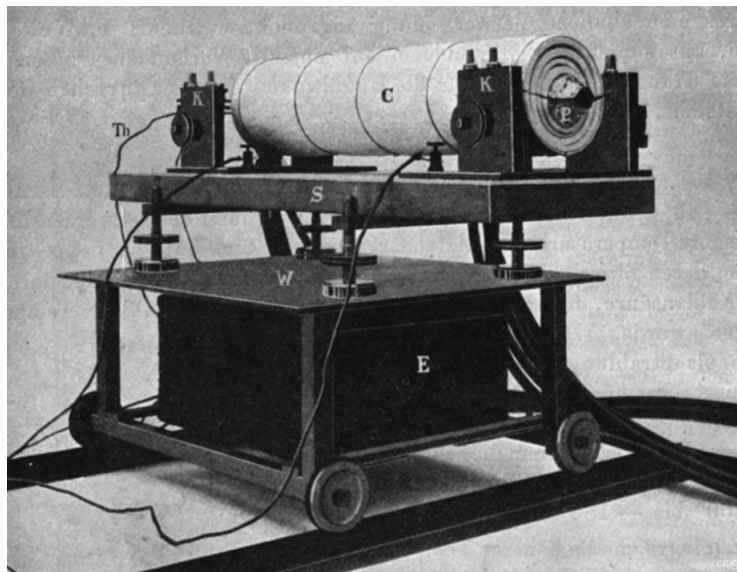

Figure 4: The electrical glowing black body, designed by O. Lummer and F. Kurlbaum 1898.

It consists of a platinum sheet of 0,01mm thickness and about 40cm length; it is shaped as a cylinder with a diameter of 4cm, whose one end is squeezed and closed. On both ends there are rings (R) for the electrical supply, which is used for heating. With a current of about 100A one could attain temperatures of about 1500°C. Into the inner space of this heating case is located a porcelain tube with the radiating cavity (E). A thermo couple is also integrated into this tube for measuring the temperature of the cavity. Several diaphragms (1-6) belong to the arrangement, too, which should shelter the cavity for outer disturbances—incoming cold air etc. The inner surface of the tube was blacked with a mixture of chromium, nickel and cobalt oxide. For isolating purposes the whole arrangement is surrounded by a second tube of fire proved material; the isolating effect could be improved by covering with extra tubes or asbestos sheets.

(aus einem 0,01 mm dicken Platinblech, welches zu einem Zylinder von 40 cm Länge und 4 cm Durchmesser gebogen ist, an dessen Ende dicke Ringe für die Stromzuführung angebracht sind. In diesen Heizmantel paßt eng anschließend das Innere der beiden Rohre einer schwer schmelzbaren Masse (z.B. Porzellan). Diese hat fest eingebrannt in der Mitte eine Querwand, sowie eine Reihe von Diaphragmen, die den eigentlichen Hohlraum vor Abkühlung durch eindringende Luft schützen sollen. Die innere Oberfläche des Strahlungsrohr ist mit einem Gemisch von Chrom-, Nickel- und Kobaltoxyd geschwärzt. Zum Schutz gegen Wärmeverluste ist über das Platinrohr mittels eng anschließender Ringe ein zweites Rohr aus einer feuerfesten

Masse geschoben, so daß zwischen beiden Röhren ein isolierender Hohlraum entsteht. Zur weiteren Wärmeisolation können bei Bedarf weitere Rohre oder Asbestpappe übergeschoben werden. Mit einem Strom von etwa 100 A ließen sich Temperaturen von bis zu 1520°C erreichen.)

By the way, with this design of a black body for higher temperatures and on the basis of Boltzmann's law there was a new possibility to define the temperature—in particular for high temperatures, where the common gas thermometers or the thermocouple don't work. Instead using the common gas laws one could define now the temperature on the basis of the relation $E = T^4$ with the radiation of a black body. For these purposes Lummer and Pringsheim developed later (1903) an additional black body, with which one could reach temperatures of about 2100°C.⁹⁶ Instead of platinum, whose melting point was too low for these temperatures, the radiating cavity of this black body consists of an electrically heated graphite tube, which was located into a specific gas atmosphere, since in ordinary air the graphite would be blown up immediately. With this design the complete black body had got more or less its final shape, which is still used in today's radiation research. Later improvements affected only marginal details of the design—for instance the use of a specific kind of graphite, the so called pyrolytic graphite, or similar things.

The design of the “electrical glowing complete black body” was a big progress for the radiation research in general. A progress not only for the practical aims of the PTR, but for the experimental proof of the radiation laws at all—the mentioned confirmation of the Stefan-Boltzmann Law and of Wien's displacement law show it obviously. The latter was announced by Lummer and Pringsheim in the annual report of the PTR for 1898/99, reported in a meeting of the Physical Society in Berlin and in a session of the Prussian Academy of Sciences as well.⁹⁷ With this success one can also detect a general shift of the radiation research at the PTR, since a more physical approach moved in the foreground now. The annual report for 1899/1900 records this development in this way: “The aim of the optical investigations is to prove the fundamental laws for the heat and light radiation”.

For this aim the PTR possessed not only excellent preconditions with its black body design, but some other prerequisites were provided by the scientists at the PTR. The latter include at all the development of highly advanced techniques for the detection of radiation and for extending the measurements over large frequency ranges. We already mentioned Otto Lummer's merits for the improvement of modern photometry and an accurate measurement of the power of light. However the photometer was only usable for the visible part of the spectrum, but the common

⁹⁶ O. Lummer, E. Pringsheim: Die strahlungstheoretische Temperaturskala und ihre Verwirklichung bis 2300° abs. Berichte der Deutschen Physikalischen Gesellschaft 1(1903) 3-13.

⁹⁷ O. Lummer, E. Pringsheim: Die Vertheilung der Energie im Spectrum des schwarzen Körpers. Verhandlungen der Deutschen Physikalischen Gesellschaft 1(1899)23-41.

light sources emit less (visible) light as heat. The measurement of such radiation, in particular of infrared rays, was substantially improved, when the American astrophysicists Samuel Langley invented the so called "bolometer" in 1881. This instrument used the temperature-dependent change of the resistivity of platinum blacked wires. In principle it was a Wheatstone bridge with similar narrow platinum strips in opposite arms, one of which was exposed to radiation. The absorbed radiation heated the platinum strip and is measured by comparison with an equivalent electrical heating power. With it Langley could measure a temperature difference of about 10^{-5} °C with an error of about 1%. Langley used the bolometer mainly for astrophysical investigations, for instance to study the solar constant by integrating the energy versus wavelength curves or the selective absorption of the sun's and earth's atmosphere.⁹⁸ Langley's invention was very successful and during the 90ies it became one of the most used instruments for the precision measurement of radiation and its spectral distribution.

Referring to these developments and the PTR's own engagement in radiation research, Otto Lummer pursues his claim, that "the bolometer should be used for the aims of photometry".⁹⁹ (*Es sollte das Bolometer in den Dienst der Photometrie treten.*) He began with these investigations immediately after the invention of his new photometer, i.e in the early 90's and years before his efforts for the design of a complete black body. The improvement of the bolometer technique was a very difficult business, since the bolometer had already got a very high standard with Langley's invention. Therefore the point was not to improve the sensitivity of Langley's bolometer in general, but to improve its measurement techniques in particular and to adopt it for special applications—for instance, for comparing different light sources. For these purposes Lummer made some improvements, which concern less the sensitivity of the bolometer for temperature differences, but its stability and "inertia" (the frequency of measurements) during the process of measurement; furthermore one could also irradiate Lummer's bolometer from different sides at the same time, which was very important for the comparison of light sources and for gauging the bolometer, too.

For the improvement of Langley's bolometer Lummer introduced special methods of manufacturing the bolometer strips. Langley had used more or less ordinary platinum wires, whose heat capacity were relatively high and changed very much in their electrical properties. For manufacturing identically platinum strips of low heat capacity Lummer and Kurlbaum developed an ingenious method, which is an early example of the today's microstructure techniques (*Mikrostrukturtechnik*). This procedure consist of five steps (see figure 5)¹⁰⁰:

⁹⁸ Ch.D. Walcott: Biographical Memoir of Samule Pierpont Langley (1834-1906). National Academy of Sciences VII(1912)249.

⁹⁹ O. Lummer, F. Kurlbaum: Bolometrische Untersuchungen. *Annalen der Physik* 46(1892)205.

¹⁰⁰ *Ibid.*, p. 217-219.

1) Rolling

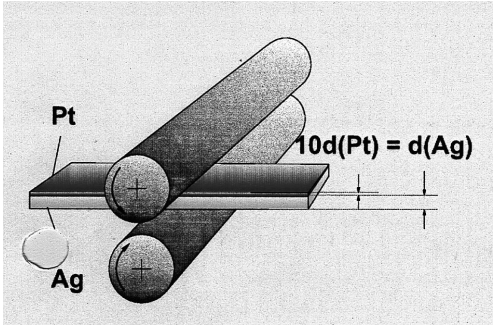

2) Cutting

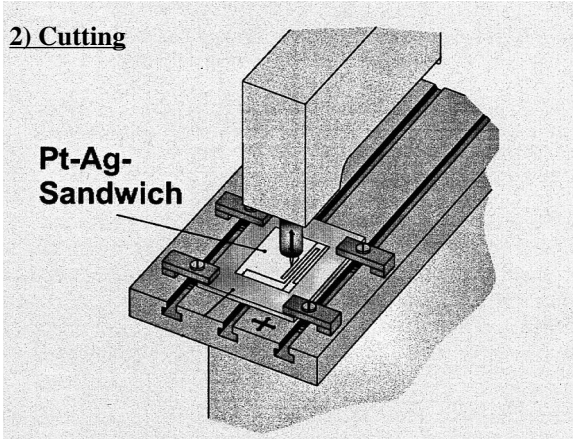

3) Framing

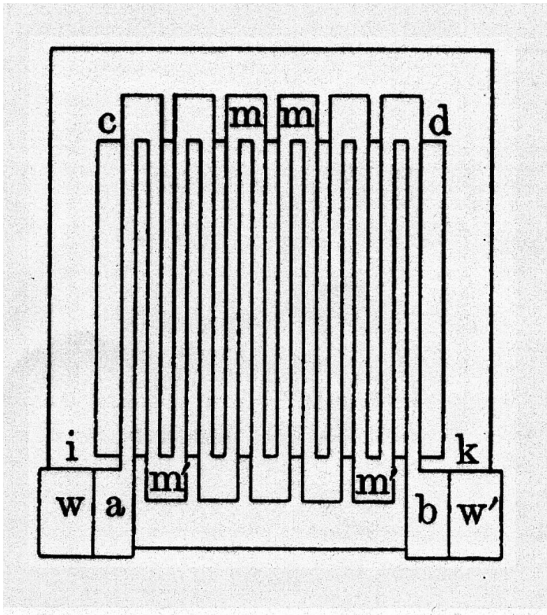

4) Etching and Flushing

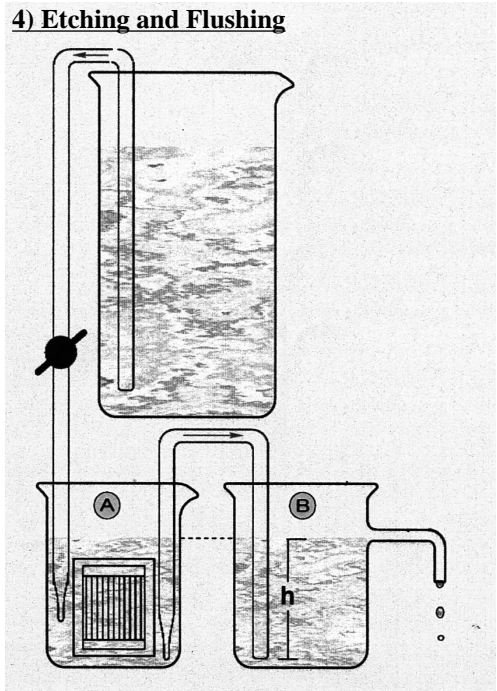

5) Blacken

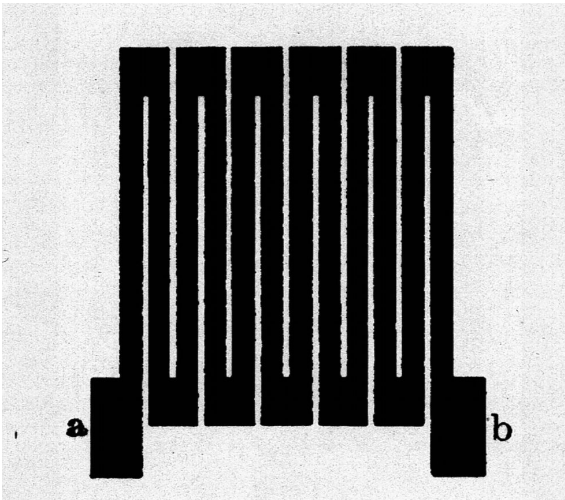

Figure 5: Manufacturing the bolometer strips.

1) Rolling

The platinum sheet is welded together with a silver sheet of ten times thickness. This sandwich structure is rolling up to a thickness of the platinum of about 10^{-6} m.

2) Cutting

The rolled sandwich is pasted on a glass plate and a dividing machine is cutting a meandering structure of it.

3) Fixing on a frame

After taking off the Pt-Ag-structure from the glass plate the structured sheet is fixed on a slate frame and covered with shellac; furthermore it is equipped with electrodes for the power supply.

4) Etching and Flushing

The slate frame is putting in a vessel with acid, which etches the silver. Since the surviving platinum structure is very fragile it is necessary to carry out a special procedure for the flushing process and to take out the frame—the surface tension of pure water would destroy the thin platinum frame.

5) Blacken

After this procedure the prepared element is blackening in a flame. Later this procedure was also improved. Instead of the soot of a flame it was used the so called "Platinmoor", an electrolytically produced kind of platinum, which blackness was much better and more reproducible.¹⁰¹

Four of such as identical as possible elements shaped now the four strips of the Wheatstone bridge of the bolometer. The finished large area bolometer (figure 6) is put in a case for sheltering the bolometer from outer disturbances—air streams in particular. With the most sensitive constructions of such a bolometer one could detect temperature changes of about 10^{-7} °C and the frequency of measurements of it runs down to about 8sec (Langley's bolometer had still one of about 100 sec.). Another advantage was, that in 1898 Lummer and Pringsheim had also produced with this procedure the so called linear bolometer.¹⁰² The latter consists of only one sector at the slate frame and is fitted in a round ocular holder (figure 7).

¹⁰¹ Die Thätigkeit der Physikalisch-Technischen Reichsanstalt in der Zeit vom Dezember 1892 bis Februar 1894. Zeitschrift für Instrumentenkunde 14(1894) 266.

¹⁰² O. Lummer, E. Pringsheim: Die Vertheilung der Energie..., a.a.o.

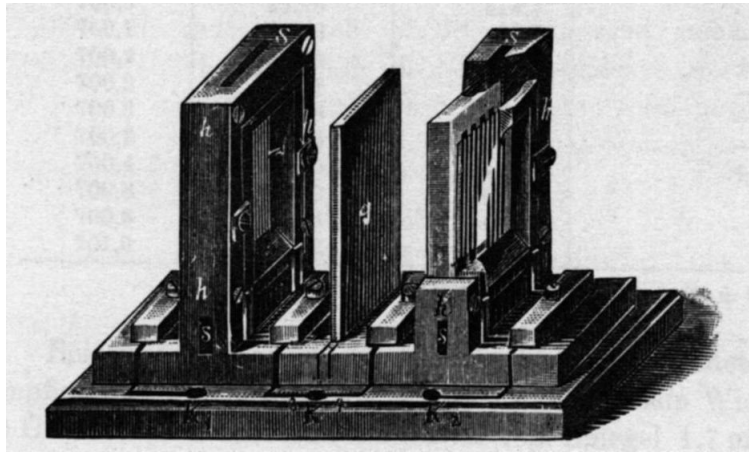

Figure 6: Large area bolometer, designed by O. Lummer and F. Kurlbaum 1892.

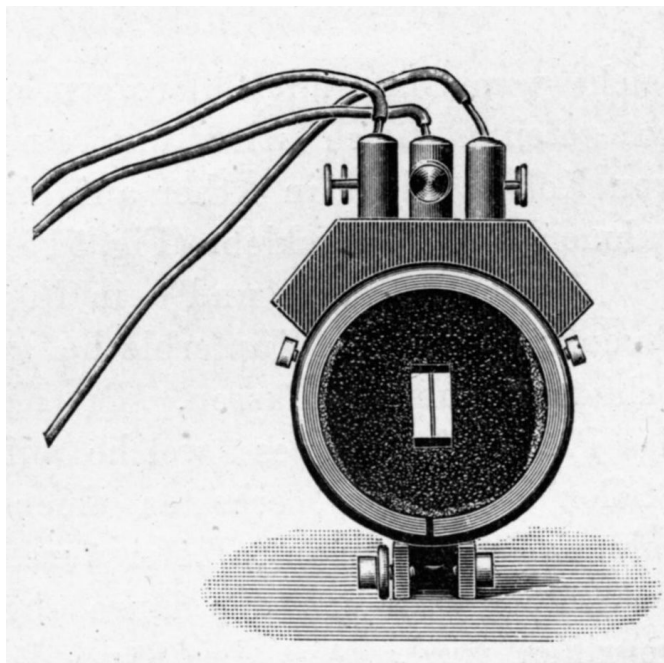

figure 7: Linear bolometer, designed by O. Lummer and E. Pringsheim 1898.

With these two modifications of a bolometer and the design of a usable black body one was now in possession of the experimental possibilities to prove the fundamental radiation laws. As already mentioned this took place very quickly since 1898¹⁰³: first the validity of Boltzmann's law was confirmed with the “large area” bolometer and with the linear bolometer one could confirm Wien's displacement law. For this purpose one had developed a so called spectrobolometer (figure 8), which is designed like a spectrometer, but also usable for the invisible part of the spectrum. Therefore the common used glass lenses were replaced by silver mirrors (I and

¹⁰³ See the annual reports of the work of the PTR in the journal “Zeitschrift für Instrumentenkunde” 1899ff

II) and the prism (P) as well as other parts of the instrument is made by special materials, which could transmit not only the visible light. This instrument allowed for precision measurements of the black body spectrum up to the far infra red.

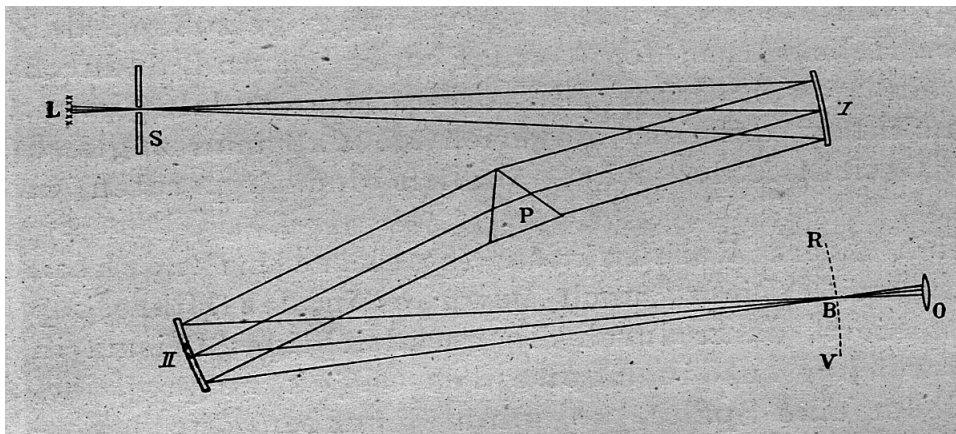
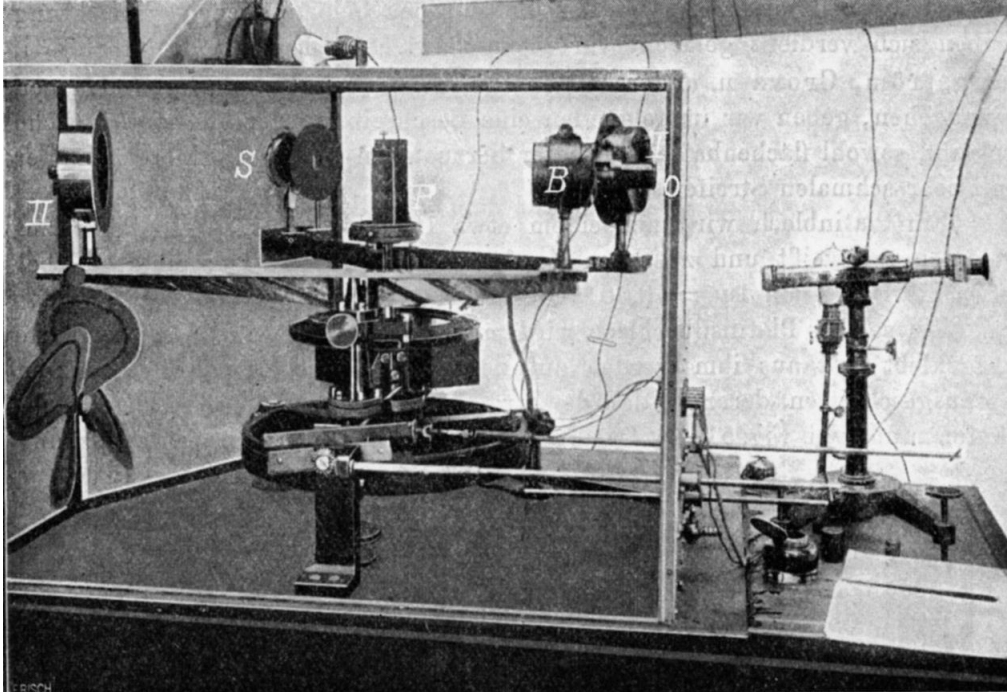

Figure 8: The spectrolometer.

The spectrolometer was also very useful for the further investigations on the general energy distribution in the spectrum of black body radiation, which should test Wien's law of radiation—the latter had the most credit among the physicists at that time. As we know these investigations reveal significant deviations from Wien's theoretical radiation law. First Lummer and Pringsheim reported at a session of the Berlin Physical Society on February 3rd, 1899 on mea-

surements up to $6\ \mu\text{m}$ and at temperatures of the black body between 800°C and 1400°C , which gave some hints of deviations from Wien's law.¹⁰⁴ After further improving their measurements and extending their range of observations, of which they had already spoken, later in the year, in November 1899, they stated that there were “discrepancies of systematic nature between theory and experiment”¹⁰⁵ (*daß die Abweichungen zwischen Theorie und Beobachtung systematischer Natur sind*), but for a final decision in this question they suggested to extend the experiments for higher temperatures and longer wavelengths.¹⁰⁶

Although Lummer and Pringsheim could find in the following months more deviations from Wien's formula¹⁰⁷, the unclear situation remains up to the fall of 1900. Crucial for that was, that Friedrich Paschen in Hannover, the other pioneer of experimental radiation research, had made similar precision measurements, which showed a satisfying agreement with the theoretical formula. The turning point came neither from Lummer and Pringsheim nor from Paschen in Tübingen, but with the introduction of a new method, which brought a further extension of the investigated spectrum up to the longest wavelengths obtained until then, about $50\ \mu\text{m}$. This range of the spectrum opened up the so called method of residual rays (see figure 9), which was developed by the Berlin physicists Heinrich Rubens and his American student Ernst F. N. Nichols.¹⁰⁸ The method (see also figure 9) used the fact, that all substances reflect radiation especially strongly in the region of strong absorption and one can select by multiple reflections at such substances specific rays of a very homogenous wavelength: for instance with the reflecting substance quartz = $8,85\ \mu\text{m}$; fluorite = $24\ \mu\text{m}$ and $31,6\ \mu\text{m}$; rock salt = $51,7\ \mu\text{m}$ or sylvine = $63,4\ \mu\text{m}$.

¹⁰⁴ O. Lummer, E. Pringsheim: Die Vertheilung der Energie ... a.a.o.

¹⁰⁵ O. Lummer, E. Pringsheim: Die Vertheilung der Energie im Spectrum des schwarzen Körpers. Verhandlungen der Deutschen Physikalischen Gesellschaft 1(1899) 215-235.

¹⁰⁶ Ibid., p.226

¹⁰⁷ See their talk at the session of the Berlin Physical Society on February 2nd, 1900: Über die Strahlung des schwarzen Körpers für lange Wellen. Verhandlungen der deutschen Physikalischen gesellschaft 2(1900) 163-180.

¹⁰⁸ H. Rubens, E.F.N. Nichols: Versuche mit Wärmestrahlen von großer Wellenlänge. Annalen der Physik 60(1897)418-496.

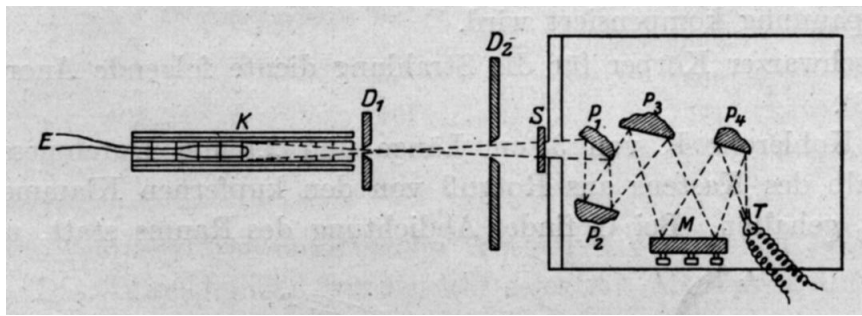

Figure 9: The method of residual rays, developed by H. Rubens during the late 1890ies.

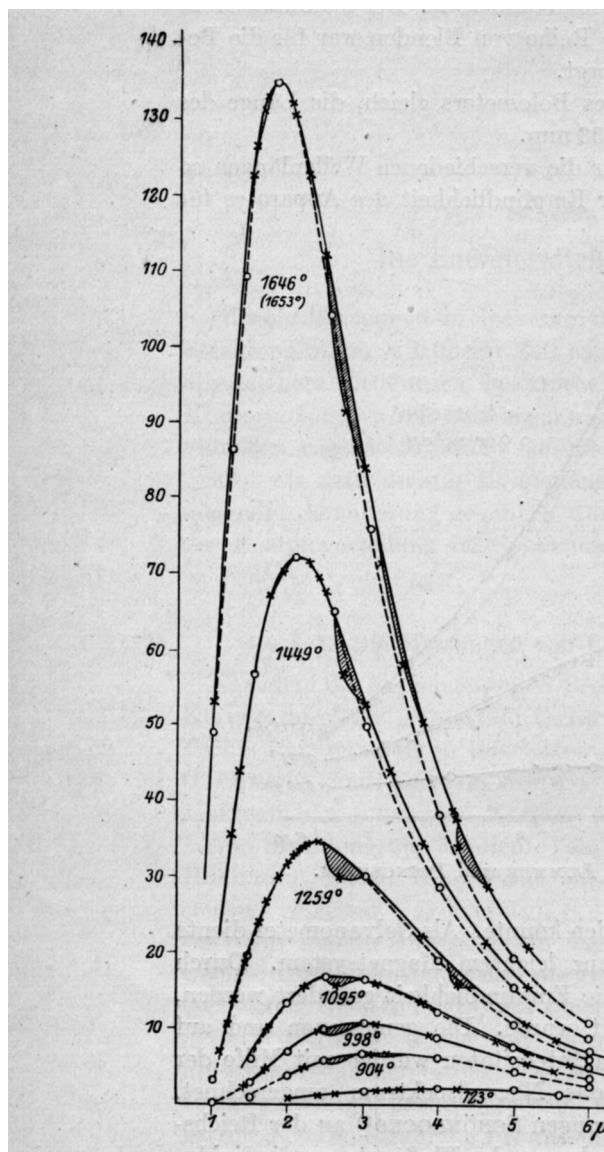

Figure 10: The PTR measurements of the radiation spectrum of a black body at different temperatures with significant derivations from Wien's theoretical radiation law (broken lines).

During the summer 1900 Rubens and Kurlbaum carried out measurements with this method testing the validity of the radiation laws and observed increasing deviations from Wien's theoretical radiation law at long wavelengths and for higher temperatures (figure 10). Max Planck, professor for theoretical physics at Berlin's university and recognized specialist for the theory of radiation laws, was informed by Rubens about the results of his investigations before its public presentation at the session of the Berlin Physical Society on October 19th:

“When on Sunday, 7 October 1900, Rubens together with his wife visited Planck, the discussion turned to the measurements with which Rubens was occupied. He said that for the longest wavelengths, the law recently proposed by Lord Rayleigh was valid. An universally valid law had to turn into this formula for big λT .”¹⁰⁹

This became also the turning point for Planck's theoretical work, since very suddenly he found by extrapolation his well known formula for a new radiation law, which satisfied the experimental data very much.

“The same evening still he reported this formula to Rubens on a postcard, which the latter received the following morning. One or two days later Rubens went to Planck, and was able to bring him the news that the new formula agreed perfectly with his observations.”¹¹⁰

(Als am Sonntag, dem 7. Oktober 1900, Rubens mit seiner Frau bei Planck einen Besuch machte, kam das Gespräch auch auf die Messungen, mit denen Rubens beschäftigt war. Er erzählte, daß bei seinen längsten Wellen das kürzlich von Rayleigh aufgestellte Gesetz... gelte. Eine allgemeingültige Strahlungsformel müsse jedenfalls für große λT in diese Form übergehen. Auf dieses Gespräch hin stellte nun Planck sogleich folgende Rechnung an... Noch am demselben Abend teilte er Rubens diese Formel auf einer Postkarte mit, die dieser am nächsten Morgen erhielt. Ein oder zwei Tage darauf ging Rubens wieder zu Planck und konnte ihm die Nachricht bringen, daß die neue Formel vorzüglich mit seinen Beobachtungen stimme.)

At the next meeting of the Berlin Physical Society, on October 19th, 1900, Kurlbaum gave a talk and reported about his and Rubens' experiments “on the emission of long wave lengths by black bodies” and during the following discussion Planck gave a prepared contribution “on an improvement of Wien's Spectral formula” (see figure 11). With that ends the story of the experimental prerequisites of the foundation of the quantum hypothesis, since the next step was done by the theory only. As we know, six weeks later, again at a session of the Berlin Physical Society on December 14th, Max Planck presented a first theoretical explanation for his ad hoc introduction of his radiation formula and inaugurated with it the emergence of the quantum theory.

¹⁰⁹ G. Hettner: Die Bedeutung von Rubens' Arbeiten für die Plancksche Strahlungsformel. Die Naturwissenschaften 10(1922) 1036.

¹¹⁰ Ibid.

Sitzung der Physikalischen Gesellschaft vom 19. October 1900.

Vorsitzender: E. Warburg Schriftführer: H. du Bois

	Name des Vortragenden	Inhalt des Vortrags
Ort: großer Saal	H. E. Lampe	Nachruf für R. Hoppe
	H. F. Kurlbaum	H. Rubens: über die Emission langw. Wellen durch den schwarzen Körper bei verschiedenen Temperaturen.
	M. Planck	macht einen einigen Vorschlag an einen eingeladenen Disputanten betheiligten sind die Herren Rubens, Thomson, Poincaré, Larmor
Sie Mitglieder werden gewählt über		
Ausgeschieden		Einseitige Beschlüsse und Mittheilungen
Sie Mitglieder wurden vorgeschlagen		
Nach:	Durch	den
Prof. Dr. O. Scharlemann, Karlsruhe		Erklärung
Dr. S. Tarschewski, Petersburg		A. Krumm

Jahrg. 2. Nr. 13.

Verhandlungen
der
Deutschen Physikalischen Gesellschaft.

Sitzung vom 19. October 1900.

Vorsitzender: Hr. E. Warburg.

Der Vorsitzende theilt mit, dass die Gesellschaft auf dem internationalen Physikercongress in Paris durch die Herren du Bois (Berlin), Drupe (Giessen), Lummer (Berlin), Voigt (Göttingen), Warburg (Berlin) als Delegirte vertreten war.

Er legt ferner den ersten Band der Fortschritte der Physik für das Jahr 1899 vor, erinnert daran, dass die ersten beiden Bände auch ohne den dritten zu dem Vorzugspreis von Gesellschaftsmitgliedern bezogen werden können, und empfiehlt die Anschaffung der Fortschritte für die Institutsbibliotheken.

Hr. E. Lampe spricht dann einen Nachruf für Professor Dr. Reinhold Hoppe.

Hr. F. Kurlbaum berichtet nach gemeinsam mit Hrn. H. Rubens angestellten Versuchen über die Emission langer Wellen durch den schwarzen Körper.

Bei der sich an diesen Vortrag anschliessenden lebhaften Discussion spricht Hr. M. Planck über eine Verbesserung der Wien'schen Spectralgleichung.

Figure 11: Report of the session on October 19th, 1900, from the minute book (above) and the Verhandlungen (below) of the German Physical Society.

CONCLUSION

With my story about the experimental prerequisites of the foundation of the quantum theory I wish to demonstrate that the standard picture of the emergence of Planck's quantum hypothesis and the quantum revolution in general is a bit too narrow. It underestimates not only the importance of experimental developments for the creation of Planck's so called "Akt der Verzweiflung," but it also reduces the interaction between experiment and theory more or less to an episode concerning the very last period, the months when the physicists at the PTR discovered significant deviations from the radiation law then believed to be valid. This standard picture also transforms the experimentalists into an executive organ of the theoreticians employed for testing their approaches and theories. Such a view neglects not only the significance of experimental and instrumental developments, but also the importance of the propagation of quantitative knowledge, which is characteristic of experimental research and its instrumental innovations. However, it was precisely this experimental development which eventually brought radiation theory to such a mature of elaboration as to create a space for the emergence of the quantum discontinuity. In fact Planck's abandonment of his previous theoretical convictions in an "act of despair" was only possible, because he was privy to their work and trusted the experimental results of his colleagues from the PTR. In other words, following a tradition founded by Helmholtz Planck cultivated an intense interaction between theoreticians and experimentalists in the Berlin's physical community.

The results in the field of radiation research were based on a long-term accumulation of knowledge and a highly developed culture of precision measurements. For decades, the development of radiation took place within a framework constituted by both technological demands and basic research interests. In this sense, the radiation laboratory was a microcosmos where these different pursuits intersected. It seems to be an irony that, for a long time, the quantum revolution was not recognized by its initiators. But perhaps it is not. Even after 1900 experimental research was still guided by classical concepts. It was part of an advanced culture of precision measurements, aiming at securing experimental facts. In this context it did not really matter that these precision measurements now included the task of determining the accurate value of the new fundamental constant h . It was, on the other hand, precisely the massive empirical evidence accumulated by these continuous experimental efforts that prepared the ground for the eventual acceptance of the quantum hypothesis as a revolution initiated by Planck's 1900 paper.¹¹¹

¹¹¹ See D. Hoffmann: *Naturwissenschaft und Technik und die Berliner Wissenschaftslandschaft um 1900*. In: *Naturwissenschaft und Industrie um 1900*, Schriftenreihe der Georg-Agricola-Gesellschaft Bd. 21, Bochum 1997, S.64ff.