



MAX-PLANCK-INSTITUT FÜR WISSENSCHAFTSGESCHICHTE

Max Planck Institute for the History of Science



Cover:

Aurora borealis paintings by William Crowder,
National Geographic (1947).

The International Geophysical Year (1957–8) transformed research on the aurora, one of nature's most elusive and intensely beautiful phenomena. Aurorae became the center of interest for the big science of powerful rockets, complex satellites and large group efforts to understand the magnetic and charged particle environment of the earth. The auroral visoplot displayed here provided guidance for recording observations in a standardized form, translating the sublime aesthetics of pictorial depictions of aurorae into the mechanical aesthetics of numbers and symbols.

Most of the portrait photographs were taken by Skúli Sigurdsson

RESEARCH REPORT 2010—2012

MAX-PLANCK-INSTITUT FÜR WISSENSCHAFTSGESCHICHTE

Max Planck Institute for the History of Science

Introduction

The Max Planck Institute for the History of Science (MPIWG) is made up of three Departments, each administered by a Director, and several Independent Research Groups, each led for five years by an outstanding junior scholar. Since its foundation in 1994 the MPIWG has investigated fundamental questions of the history of knowledge from the Neolithic to the present. The focus has been on the history of the natural sciences, but recent projects have also integrated the history of technology and the history of the human sciences into a more panoramic view of the history of knowledge. Of central interest is the emergence of basic categories of scientific thinking and practice as well as their transformation over time: examples include experiment, observation, normalcy, space, evidence, biodiversity or force. Because the research of the Institute pursues questions of philosophical epistemology historically, the common perspective of the diverse research activities is often called “historical epistemology.” This Research Report describes in detail the work of all of the MPIWG’s research units 2010–12. This work would not have been possible without the support of our Advisory Board. We hope that the results presented in this report will reward the reading.

At any given moment, there are approximately seventy-five scholars working at the MPIWG, from pre- and post-doctoral fellows to senior visiting scholars. Their backgrounds are multi-disciplinary and international; their projects engage topics from ancient cosmologies to the acoustical design of modern theatres, from Renaissance alchemical laboratories to the sciences of Big Data. Although many are working on individual projects (a dissertation, an article, a monograph), all are part of the larger thematic research projects described in these pages. Since its inception, the MPIWG has encouraged collective research and publication in the humanities in the form of Working Groups that combine the expertise of many specialties and encourage sustained discussion on topics that cut across continents, centuries, and disciplines.

The three Departments of the Institute approach questions of historical epistemology in different ways. The Departments are organized neither along disciplinary lines, nor according to historical periods. Their work embraces numerous scientific disciplines and large historical timescales. Department I, directed by Jürgen Renn, focuses on

structural changes in systems of knowledge and investigates long-term processes of changes in scientific knowledge. Longitudinal studies examining the development of scientific knowledge from ancient to modern times are complemented by transversal studies dedicated to global processes of knowledge transfer and transformation. Department II, directed by Lorraine Daston, investigates the history of the ideals and practices of rationality: epistemic categories and associated practices that have become so fundamental for the modern natural and human sciences that they seemingly defy history, including scientific objectivity, observation, and data. Department III, directed by Hans-Jörg Rheinberger, studies experimental systems and spaces of knowledge. The scope of its historical subjects is broad, with special emphasis on the history of the modern life sciences and the epistemology of experiments. Department III completed its work in January 2011 with a festive retrospective of its many projects; Hans-Jörg Rheinberger himself will remain at the Institute until 2014.

Professor Dagmar Schäfer, formerly of the University of Manchester, U.K., has accepted the directorship of Department III and will begin building up its research program on “Artefacts and Action in Systems of Knowledge” as of August 1, 2013. Department III will study the history of knowledge and action. Its topics will be the processes and structures that lead to varying configurations of collaborative and individual bodies of knowledge as well as the changing role of artefacts — texts, objects and spaces — in the creation, diffusion, and use of scientific and technological knowledge. Research cases will include Asian cultures and the Pre-modern era.

In 2011, Professor Glenn W. Most (Scuola Normale, Pisa, Italy/ University of Chicago, USA) was elected External Member of the MPIWG by the Max Planck Society. Together with Professor Anthony Grafton (Princeton University, USA), he organized a Working Group on the “Learned Practices of Canonical Texts” at the MPIWG in 2012 (see p. 82–83). As of this writing, the MPIWG is proud host to seven smaller independent research groups, variously funded, led by Sabine Arnaud, Jochen Büttner, Vincenzo De Risi, Sven Dupré, Elaine Leong, Veronika Lipphardt, and Viktoria Tkaczyk. All MPIWG research units cooperate with one another both formally and informally, as common interests dictate.

Over the past years, local cooperation with Berlin universities has intensified, resulting in a formal cooperation agreement in 2007 involving the Max Planck Society, the Free University and the Humboldt University and extending to the Technische Universität Berlin in 2011. The result has been shared independent research groups between the MPIWG and the Berlin universities as well as the creation of new positions in the history of science at the universities. Additionally, the MPIWG is part of the Excellence Cluster TOPOI (see p. 46) and the Berlin School of Mind and Brain. These developments have led to an extraordinary concentration of scholarly talent in Berlin, representing the most diverse specialties in the history of science, technology, and medicine. But the whole is still less than the sum of the parts. The next step toward greater integration of MPIWG and university resources in the history of science would be the creation of a Berlin Center for the History of Knowledge. The Center would pursue three closely connected goals: encouraging an interdisciplinary dialogue with the goal of developing a comprehensive cultural history of knowledge, promoting exchanges among natural, social, and cultural sciences, and supporting

the creation of international research networks. As a first step in this direction, the MPIWG and the three Berlin universities will jointly advertise eight postdoctoral fellowships in the history of science and knowledge in 2013 with support of a Network Grant from the Max Planck Society.

The MPIWG has undertaken collaborative research projects with other Max Planck Institutes such as the Bibliotheca Hertziana in Rome, the Max Planck Institute for European Legal History in Frankfurt am Main, the Kunsthistorisches Institut in Florence, the Fritz Haber Institute in Berlin, the Albert Einstein Institute for Gravitational Research in Golm, and the Max Planck Institute for Comparative Public Law and International Law in Heidelberg. International cooperations have been extended beyond the well-established close partnerships in Europe, with universities and research institutions in Brazil, Canada, China, India, Israel, Mexico, Mongolia and the United States.

Although the MPIWG aims to innovate first and foremost in research, it has also pioneered new forms of publication and the exploitation of new source materials. The MPIWG has created a new genre of publication, “Working Group volumes,” which are the result of years of collaborative research by teams of scholars, in contrast to the more familiar conference proceedings or edited volumes. *Sources of the Max Planck Research Library for the History and Development of Knowledge*, a new series that makes volumes available by print-on-demand and as open-access online, exploits the rapidly evolving electronic facilities that are transforming scholarly publication.

Supporting the scholars at the MPIWG is an unusually friendly and efficient, if chronically over-worked staff. The Library (which has now grown to some 70,000 volumes plus many digitalized sources), the IT Group, the secretaries, the student research assistants, the Research Coordinators, and the Administration make our research possible, and we take this opportunity to thank them warmly.

Berlin, April 2013

Obituaries

Peter Damerow (1939–2011)

We mourn the loss of Peter Damerow, mathematician, philosopher, educational researcher, and historian of science, as well as the first senior scientist of this institute. He substantially contributed to its development from its foundation to the last days of his life.

It is impossible to overestimate Peter's contribution to promoting the history of science, through impulses given in conversation, through his critical reviews, and through the inexhaustible energy he brought to ongoing research projects. In all of his endeavors, he was guided by the vision that from the history of science a historical, empirically based theory of the development of knowledge could be extracted, a vision that is discussed today in connection with "historical epistemology." His own works in this vein include exemplary studies on the development of the number concept, which not only were based on a wealth of empirical material, but also elaborated theoretical foundations for a historical epistemology of this kind.

Peter never considered the history of science to be a specialized discipline; instead, he viewed it as a research area that was part of his comprehensive interest in the development of human cognition. He was thus also a pioneer of an interdisciplinary conception of the history of science. Even his early works on the emergence of script and counting had made clear that the emergence of abstract concepts can be understood only if we take seriously the role of those material representations of thought that are given in concrete historical cases, and the potential for actions and reflection they enable, as for instance the specific role played by cuneiform script tablets in the administration of Babylonia. This insight allowed him to contribute to completely different kinds of fields, for instance to cultural anthropology, and to apply his findings to other research projects at the institute, such as a history of mechanical knowledge from antiquity to Einstein, an epistemic history of architecture, theories of the globalization of knowledge, and a project on the historical development of spatial thinking. He was also a visionary and pioneer of the digital humanities and a creative protagonist of open access.

In Peter Damerow we have lost a visionary teacher, colleague, and friend. He challenged us intellectually, radically, and without compromise — and was just as unconditionally loyal and helpful in all human endeavors. He left his mark on many a biography and pointed out new paths for many research institutions. For years to come, books and articles will appear that were influenced by his thought and to which he contributed decisive ideas. He had astonishing energy and endurance, in both his work and his commitment to people. He was at the same time a brilliant spirit and the most cooperative person imaginable, even though or perhaps because he demonstrated such great perseverance.

Yehuda Elkana (1934–2012)

We also mourn the loss of Yehuda Elkana, a great intellectual and a pioneer in the contextual history of science. For him, science was deeply rooted in social, material, and cultural contexts that need to be taken into account when addressing the challenges of humanity today. Yehuda always thought big: “rethinking the Enlightenment” and turning from “local universalism to global contextualism” are just two of the grand themes of his intellectual quest.

Yehuda pursued what he called “comparative epistemology” in the twofold sense of historically reflecting on the contexts of knowledge generation and circulation, and encouraging us to rethink the seemingly evident. As a survivor of the Holocaust, he neither locked his experiences away nor allowed them to determine his, or our, future. Rethinking science in its contexts thus involved for him a deeper understanding of its social, cultural, material, and intellectual history, while keeping in mind the concerns of our future. Yehuda’s writings combined historical insights with the desire to address future challenges, and often with concrete, moral, and political issues.

In the course of his life, Yehuda assumed numerous institutional responsibilities, such as director of the Van Leer Institute in Jerusalem, head of the Cohn Institute at Tel-Aviv University, Permanent Fellow of the Wissenschaftskolleg zu Berlin, and rector of the Central European University in Budapest. He also was one of the founding fathers of this institute and over many years, including his last, one of its prominent guest scholars. In these functions, he always made sure that the highest intellectual standards were maintained; that opportunities were opened to the young, outsiders, and the underprivileged; that unusual ideas would be given a chance; and that the mainstream would not prevail.

Yehuda wrote about a broad array of subjects, from nineteenth- and twentieth-century physics, to the philosophy of Ernst Cassirer, to curriculum research in the twenty-first century. Over many years, he developed and practiced new forms of teaching that met with worldwide interest, particularly concerning his ideas about curricula and university reform. For him, his institutional and his intellectual work were never separate entities. He enjoyed mixing the spheres.

In the private as well as in the public sphere, Yehuda Elkana brought together people from the most diverse backgrounds. For those of us who had the good fortune to meet him, he quickly became a friend, a teacher, a mentor, a sharp critic, and a good colleague. He was open and direct, curious about and supportive of one’s intellectual pursuits, and concerned about the personal lives of those around him. He was capable of summing up a long discourse in a short, witty, or caustic remark, was always better read than most, and both demanding and generous with his own intellectual gifts.

Yehuda Elkana confronted us with many challenges. The most urgent one was, and remains, that of continuing to rethink the history of science and its contexts in the light of the troubling problems which face the world and which did not leave him indifferent, as they should not leave us.

Erwin Hiebert (1919–2012) and Elfrieda Hiebert (1921–2012)

Erwin and Elfrieda Hiebert were both long and fast friends of the MPIWG, most recently as Visiting Scholars collaborating on a project about scientific acoustics and musical performance in the nineteenth century. Erwin began his career as a physical chemist but shifted to the history of science, which he taught with remarkable intensity at the University of Wisconsin at Madison and Harvard University and, as a visiting professor, at universities in Germany, China, Israel, and the United Kingdom. His interests focused on the relationship between the modern physical sciences and philosophy, particularly the ways in which new philosophical perspectives emerged in the work of scientists such as Hermann von Helmholtz, Ernst Mach, and Max Planck. He was a scholar's scholar, never more at home than among the books in his Widener Library study. The MPIWG therefore accepted his generous gift of some 500 volumes, of which over a fifth were his beloved primary sources, from his own library to ours with gratitude deepened by admiration for the tradition of close study of texts that his career represented. Yet his enduring influence in the field of the history owed at least as much to his teaching as to his research. He was an inspired and inspiring seminar teacher who inducted his students into the life of the mind as well as into the intricacies of the history of thermodynamics or the shifting relationships between science and religion. His love of ideas, his intense desire to understand their emergence and interactions, his exacting reading of texts for what they did not say as well as what they did — these traits were communicated to generations of students who gratefully learned from his example.

Elfrieda was an accomplished pianist and musicologist, who also took her Ph.D. in that subject from the University of Wisconsin at Madison. Her research interests on the history of musical performance began with chamber music and expanded to include Beethoven and Brahms. Like Erwin, she was the recipient of a Fulbright Fellowship to Göttingen in the 1950s, beginning a lifelong relationship with German music, musicology — and pianos. As a teacher of both musicology and piano, she had an intimate feel for the fingerings of the Beethoven trios about which she wrote so lucidly. For almost thirty years she was the Director of the Chamber Music Program at Mather House, Harvard University. Students were made warmly welcome at Elfrieda and Erwin's home in Belmont, and Erwin's many women graduate students felt they owed a special debt to Elfrieda for her gentle resolve to continue as a scholar and pianist alongside her wholehearted commitment to her family, at a time when many deemed the combination impossible.

Erwin and Elfrieda were frequent and spirited visitors to the MPIWG. On one memorable occasion, they teamed up for an evening lecture on Helmholtz's acoustics (Erwin) and piano performance (Elfrieda). Their theme was the extraordinary development of the science, construction, and art of the piano in the nineteenth century. Their conclusion concerning the piano might also be applied to their own careers and their marriage of sixty-nine years: "With the piano we have the clearest example of the encounter between rationality and emotionality, between science and art." We mourn them both.

Table of Contents

14 Structure and Organization of the Institute

- 14 Scientific Advisory Board
- 15 Departments
- 17 External Scientific Member
- 17 Max Planck Research Groups
- 17 Administration, Coordination, Services

Department I *Jürgen Renn*

19 Structural Changes in Systems of Knowledge

- 23 Long-Term Development of Knowledge
- 45 Globalization Processes of Knowledge
- 51 Concepts, Methods, and Implementations of Historical Epistemology

Department II *Lorraine Daston*

65 Ideals and Practices of Rationality

- 67 The Sciences of the Archive
- 81 Between the Natural and the Human Sciences
- 95 Gender Studies of Science
- 100 Science in Circulation: The Exchange of Knowledge Across Cultures, 9th–18th Centuries
- 104 History of Scientific Observation
- 105 Constructions of the Brain: The Emergence of the Neurological Adolescent
- 107 Reading and Writing Nature in Early Modern Europe
- 109 The Making of Acoustics in 16th–to 19th-Century Europe
- 111 Pre- and Postdoctoral Fellows

Essay *Hans-Jörg Rheinberger*

115 Gaston Bachelard and Albert Flocon On the Encounter of a Philosopher with an Engraver

- 115 Albert Flocon
- 116 The Encounter between Flocon and Bachelard, or: The Hand of the Engraver
- 119 *Paysages*
- 121 *Châteaux en Espagne: Work and Project*

Project

124 History of the Biomedical Institutes in Berlin-Buch

Max Planck Research Group *Veronika Lipphardt*

129 Twentieth Century Histories of Knowledge About Human Variation

131 Individual Projects

138 Workshops

143 Collaborations

145 Guest Program

Max Planck Research Group *Vincenzo De Risi*

153 Modern Geometry and the Concept of Space

155 Individual Projects

Max Planck Research Group *Sabine Arnaud*

163 The Construction of Norms in 17th- to 19th-Century Europe and the United States

164 Individual Projects

169 Events Organized

Max Planck Research Group *Sven Dupré*

173 Art and Knowledge in Pre-modern Europe

174 Written Transmission: Artists' Recipes and Books

178 Artists' Optical Knowledge

182 Color in Art and Color in Nature

185 Art and Alchemy

187 Artists Inside Collections

190 Visiting Scholars

192 Collaboration with the Freie Universität Berlin

192 Colloquia, Conferences, and Workshops

Joint Activities

Events in Honor of Hans-Jörg Rheinberger's 65th Birthday

- 197** Festkolloquium für Hans-Jörg Rheinberger
- 198** Eine Naturgeschichte für das 21. Jahrhundert
- 199** Hans-Jörg Rheinberger: A Bibliography
- 199** Epistemology and History
- 201** Historical and Biological Times

Services, Cooperation, and Outreach

- 203** Digital Humanities
- 208** Library
- 216** Cooperation and Outreach

Overviews

- 229** Researchers and Guests
- 269** Collaborations and Other External Activities
- 275** Conferences, Workshops, and Colloquia
- 279** Academic Achievements and Scientific Awards

Publications and Preprints

- 285** Publications
- 380** Preprints

- 383** Index

Structure and Organization of the Institute

Scientific Advisory Board

Prof. Dr. Fabio Bevilacqua

Dipartimento di Fisica “A. Volta”, Università degli Studi di Pavia, Italy

Prof. Dr. Francesca Bray

School of Social and Political Science, University of Edinburgh, United Kingdom

Prof. Dr. Moritz Epple

Historisches Seminar, Wissenschaftsgeschichte, Goethe-Universität, Frankfurt am Main, Germany

Prof. Dr. John Forrester

Department of History and Philosophy of Science, University of Cambridge, United Kingdom

Prof. Dr. Christoph Meinel

Lehrstuhl für Wissenschaftsgeschichte, Universität Regensburg, Germany

Prof. Dr. David Sabeau

Department of History, University of California, Los Angeles, USA

Prof. Dr. Ana Simões

Secção Autónoma de História e Filosofia das Ciências, Universidade de Lisboa, Portugal

Prof. Dr. Pamela H. Smith

Department of History, Columbia University, New York, USA

Prof. Dr. M. Norton Wise

Department of History, University of California, Los Angeles, USA



Department I
Jürgen Renn



Department II
Lorraine Daston



Department III
Hans-Jörg Rheinberger

Departments

Department I

Structural Changes in Systems of Knowledge

DIRECTOR *Prof. Dr. Jürgen Renn*

RESEARCH SCHOLARS *Antonio Becchi* (since January 2011), *Dr. Peter Beurton* (associated), *Dr. Alexander Blum* (since November 2011), *Dr. Sonja Brentjes* (since April 2012), *Dr. des. Jochen Büttner* (2004–2012, since November 2012 TOPOI Research Group Leader), *Andrey Bukhman* (until May 2011), *Giuseppe Castagnetti*, *PD Dr. Peter Damerow* (January 1997–November 2011), *Carmen Hammer* (until March 2012), *Prof. Dr. Dieter Hoffmann*, *Dr. Jeremiah James* (since January 2012), *Dr. Horst Kant* (until March 2011, associated), *Dr. Falk-Juri Knauff* (until December 2011), *Prof. Dr. Wolfgang Lefèvre* (associated), *Dr. Christoph Lehner*, *Dr. Pietro Daniel Omodeo* (since May 2011), *Dr. Albert Presas i Puig* (until September 2010), *Simone Rieger*, *Dr. Matthias Schemmel* (April 2008–October 2011 TOPOI Research Group Leader), *Dr. Arne Schirrmacher* (until November 2010), *Dr. Wolfgang Schmidle* (until August 2011), *Dr. Volkmar Schüller* (until March 2012), *Dr. Matteo Valleriani*, *Prof. Dr. Renate Wahsner* (associated), *Dr. Milena Wazeck* (until October 2010)

Department II

Ideals and Practices of Rationality

DIRECTOR *Prof. Dr. Lorraine Daston*

RESEARCH SCHOLARS *Dr. Elena Aronova*, *Nikolaus Bacht* (Emmy Noether Research Group Leader, until September 2011), *Dr. Etienne Benson*, *Dr. Grégoire Chamayou* (until October 2010), *Dr. Suparna Choudhury* (Minerva Research Group Leader, until August 2012), *Dr. Donatella Germanese* (since September 2012), *Dr. Elaine Leong* (Minerva Research Group Leader, since September 2012), *Dr. Andreas Mayer*, *Dr. Tania Munz* (until August 2010), *Dr. András Németh* (September 2011–December 2012), *PD Dr. Christine von Oertzen*, *Dr. David Sepkoski* (since September 2012), *Dr. Viktoria Tkaczyk* (Dilthey Research Group Leader, since September 2011), *PD Dr. Fernando Vidal* (until September 2012), *Dr. Annette Vogt*, *Dr. Cecelia Watson* (since August 2012)

Department III (1997–2011)

Experimental Systems and Spaces of Knowledge

DIRECTOR *Prof. Dr. Hans-Jörg Rheinberger*

RESEARCH SCHOLARS *Dr. Safia Azzouni*, *Dr. Christina Brandt* (Minerva Research Group Leader), *Dr. Bernd Gausemeier*, *PD Dr. Christoph Hoffmann* (until February 2010), *Prof. Dr. Ursula Klein*, *Dr. Julia Kursell*, *Dr. Irina Podgorny*, *Dr. Henning Schmidgen*, *Dr. Barbara Wittmann*



Glenn W. Most



Dagmar Schäfer



Veronika Lipphardt



Vincenzo De Risi



Sabine Arnaud



Sven Dupré



Hannah Lotte Lund



Claudia Paaß



Jochen Schneider



Urs Schoepflin



Dirk Wintergrün



Hansjakob Ziemer

External Scientific Member

Glenn W. Most, Professore Ordinario di Filologia Greca, Scuola Normale Superiore di Pisa
Visiting Professor of Social Thought and of Classics, University of Chicago

Max Planck Research Groups

Max Planck Research Group (2006–2011)

Concepts and Modalities: Practical Knowledge Transmission

DIRECTOR *PD Dr. Dagmar Schäfer*

Max Planck Research Group (2009–2016)

Twentieth Century Histories of Knowledge About Human Variation

DIRECTOR *Prof. Dr. Veronika Lipphardt*

RESEARCH SCHOLARS *Dr. Susanne Bauer* (until December 2011), *Dr. Alexandra Widmer* (January 2012–April 2013)

Max Planck Research Group (2010–2015)

Modern Geometry and the Concept of Space

DIRECTOR *Dr. Vincenzo De Risi*

Max Planck Research Group (2011–2016)

The Construction of Norms in 17th–to 19th-Century Europe and the United States

DIRECTOR *Dr. Sabine Arnaud*

Max Planck Research Group (2011–2016)

Art and Knowledge in Pre-modern Europe

DIRECTOR *Prof. Dr. Sven Dupré*

RESEARCH SCHOLARS *Dr. Karin Leonhard*, *Dr. Klaus E. Werner* (2012, Bibliotheca Hertziana, Rome)

Administration, Coordination, Services

Hannah Lotte Lund (until October 2010, Coordinator of the Network “History of Scientific Objects”),
Claudia Paaß (Head of Administration), *Jochen Schneider* (Research Coordinator),
Urs Schoepflin (Head of Library) *Dirk Wintergrün* (Head of Information Technology Group),
Dr. Hansjakob Ziemer (Cooperations and Public Outreach)

Members of Department I

Standing (left to right): Lindy Divarci,
Matteo Valleriani, Birgit Kolboske,
Helge Wendt, Jeremiah James,
Alexander Blum, Christian Joas,
Sabine Kayser, Sebastian Zacharias,
Christoph Lehner, Nina Ruge,
Beatrice Hermann, Martin Jähnert,
Luisa Bonolis, Petra Schröter,

Anna Perlina, Johanna Biank,
Gunthild Storeck, Moritz Hütten,
Fynn Ole Engler, Imad Samir.
Seated (left to right): Pietro D. Omodeo,
Ursula Klein, Hajime Inaba,
Matthias Schemmel, Jürgen Renn,
Giulia Giannini, Anna Holterhoff,
Isabell Draelants.



Department I

Structural Changes in Systems of Knowledge

Director: *Jürgen Renn*

Introduction

The work of the research group headed by Jürgen Renn is dedicated to understanding the historical processes of structural changes in systems of knowledge. This goal comprises the reconstruction of central cognitive structures of scientific thinking, the study of the dependence of these structures on their experiential basis and on their cultural conditions, and the study of the interaction between individual thinking and institutionalized systems of knowledge. This theoretical program of a historical epistemology is the common core of the different investigations and research projects pursued and planned by the research group. Historically, they stretch from ancient Babylonian mathematics and medicine to contemporary physics and biology, as well as the institutional history of science.

Department I understands its research program of a historical epistemology as contributing to an evolutionary history of knowledge, but also to the reflectivity of present science and its institutions. The emphasis is on macro studies to enable the identification of large-scale structures of knowledge development in social, technological, and cultural contexts. Approaches, methods, and objects of inquiry are taken from a broad array of disciplines, ranging from the history and philosophy of science, technology, and art, to the cognitive sciences and linguistics, to archaeology, Middle Eastern studies, classics, sinology, Indology, and sociology, to physics, mathematics, biology, chemistry, and other natural sciences.

The work of the Department continues to take inspiration from the challenges of present and future developments in science, tackling such issues as the role of the new information technologies, globalization, and the place of science in society. It thereby opens up opportunities for younger scholars of the Department to find positions in a broad variety of fields, including science organization and dissemination, in addition to academic positions within and outside the history of science.

Research in Department I is organized along two major axes, corresponding to the long-term transmission and transformation of knowledge and to processes of knowledge transfer and globalization, respectively. Longitudinal studies extend from the historical development of spatial knowledge by means of transformations of cosmo-

→ p. 23

→ p. 45

→ p. 51

logical and mechanical knowledge to the reorganization of knowledge in modern science. Transversal studies extend from the spread of technology and innovations in the ancient world via the diffusion of Aristotelianism to the globalization of knowledge in recent science. These studies are complemented by research on concepts and methods of historical epistemology and by the development of new tools supporting research on historical sources, interdisciplinary collaboration, and new forms of dissemination. For the research of Department I, the creation of innovative IT instruments is essential for managing the concrete historical evidence provided by heterogeneous source material.

Research traditions already established in the Department, such as the investigation of mental models in the history of mechanical knowledge, of the reorganization of knowledge in early twentieth-century physics, and of the transcultural circulation of knowledge between Europe and China, have been integrated into this larger framework and complemented by novel research activities. These include newly launched studies of the history of cosmology, of Aristotelianism, of Arabic science, of the analytic turn of science in the eighteenth century, of mental models in biological thinking, of the history of quantum field theory and quantum gravity, and of conversion processes of energy systems in history.

The scope of the Department's research has continued to expand, despite the loss of two of the most influential figures to have shaped the course of work undertaken in the Department since its inception. We deeply mourn the loss of Peter Damerow and Yehuda Elkana, who were both actively involved in our research up until their final days. Several of Peter's writings are to appear posthumously in our publications, and Yehuda, during his sojourn as visiting scholar over the last two years, launched the Curriculum Project with the help of the Mercator and the Einstein foundations.

One focal point of future research will be the sharing and accumulation processes of practical knowledge, in particular in the period between the Scientific and the Industrial Revolutions, with the aim of identifying the self-reinforcing mechanisms responsible for the coupling of epistemic and economic evolution. It will be analyzed, for instance, to which extent the integration of practical knowledge into theoretical frameworks was driven by the need for a more efficient economy of knowledge realized by processes of codification, accumulation, and transfer inherent in practical knowledge.

A second focal point will be the expansion of earlier work on structural changes in systems of physical knowledge. This research will cover the development of physics and chemistry after the quantum revolution, with a special focus on the establishment of subdisciplines of the exact sciences and the exchanges of theoretical models and research practices between them. Recent transformations within the life sciences will be studied from a comparative perspective.

In preparation for a future research program on the history of the Max Planck Society, a working group has been set up within the Department. A colloquium series and

an international symposium was held to discuss the objectives of this new project. In addition, studies focusing on individual institutes and personalities have been published.

The aim of this considerable extension of the research scope is to validate and further develop the theoretical framework guiding the research of the Department. This framework is based on conceiving of knowledge as human potential — embodied in social structures and material culture — to solve problems and to mentally anticipate appropriate actions. Knowledge encompasses internal representations such as mental models as well as external representations such as artifacts or symbols.

A mental model is an important example of the internal representation of knowledge that typically results from the internalization of an external, real model. It has a relatively stable structure that connects variable inputs from different sources that must be filled according to specific constraints. The settings that fill the variables may have different origins. They may result, in particular, from prior experience or prior reasoning. They are then designated as default settings, that is, they are taken to be true as long as there is no evidence available to the contrary. That such models may operate under conditions of incomplete information and be adapted to new situations without giving up their basic structure makes them particularly suitable for explanations of cognitive processes in the history of science.

Reflection on operations with external representations of knowledge is a major driving force for the transformation of knowledge (epistemic evolution). Knowledge systems may be reorganized in response to a variety of challenges, such as the introduction of new technology (challenging objects), the emergence of internal contradictions (borderline problems), or the transfer to a new setting (recontextualization). Knowledge systems evolve in close interaction with social structures and material conditions, giving rise to various forms of interdependence between societal and knowledge economies (socio-epistemic evolution).

As the research projects of Department I integrate insights from a wide range of disciplines, cultures, and historical periods, they are realized in cooperative networks extending well beyond the boundaries of the Institute. The Institute, however, typically represents a central node of such networks, bringing scholars together to form teams characterized by intensive cooperation over longer periods of time. A scientific coordinator is assigned to supervise each of the three central lines of research (longitudinal, transversal, methodical). Exploring and validating theoretical conclusions with reference to the vast collection of primary sources, but also building upon the existing scholarly literature, would be inconceivable without the support and substantial active participation of the Institute's library and the information management facilities that were built up with the support of the IT group.

The expansion of the scope of research activities that the Department has been able to entertain in the last years was made possible by institutional cooperation with other research centers, both in Berlin and worldwide. It has benefited from additional fund-



Jürgen Renn



Wolfgang Schön

Jürgen Renn and Vice-President Wolfgang Schön giving their welcome addresses at the Symposium on the History of the Max Planck Society, October 23, 2012.

ing from the Strategic Innovation Fund of the President of the Max Planck Society, the Deutsche Forschungsgemeinschaft, the Humboldt Foundation, the German Academic Exchange Service, the German-Israeli Foundation, the Ministry of Education, Science, and Culture of the Federal State of Mecklenburg-Vorpommern, the Mercator Foundation, the Mellon Foundation, the German Digital Library, the Max Planck Digital Library, the Golden Web Foundation, the Forum Transregionale Studien, and from other sources.

Four major inter-institutional collaborative endeavors are particularly relevant for the research strategy of the Department. Research on ancient science and technology is being pursued in the context of the project Excellence Cluster TOPOI – The Formation and Transformation of Space and Knowledge in Ancient Civilizations, which is a cooperative venture with the Freie Universität Berlin, the Humboldt University of Berlin, the Berlin-Brandenburg Academy of Sciences and Humanities, the German Archaeological Institute, and the Prussian Cultural Heritage Foundation. The Department has collaborated in particular in the foundation of the Berliner Antike Kolleg and the Berlin Graduate School for Ancient Sciences. Research on the long-term transmission and transformation of ancient science is being performed in the context of the Collaborative Research Centre 644 “Transformations of Antiquity,” at the Humboldt University. Research on intercultural knowledge transfer in the Middle Ages and the early modern period is carried out in the context of the Collaborative Research Centre 980 “Episteme in Motion” at the Freie Universität. In recent years, a close collaboration with the Fritz Haber Institute of the Max Planck Society has developed which, in the period covered by this report, manifested itself in joint research in the framework of the Quantum Project as well as in a research project dedicated to the centenary of the Fritz Haber Institute.

In the future, research on knowledge transfer and transformation will also be pursued in the context of new institutional collaborations, in particular under the umbrella of the European Research Council (ERC) Advanced Grant 2012 “Fragments of Cuneiform Medicine in the Babylonian Talmud: Knowledge Transfer in Late Antiquity” (Mark Geller) and in a joint research unit with the Freie Universität Berlin dedicated to the Intellectual History of the Islamicate World (Sabine Schmidtke).

Project

Long-Term Development of Knowledge

The history of scientific knowledge is characterized by recurrent phases of fundamental conceptual reorganization involving genetically related but mutually incompatible conceptual systems. At the same time, certain knowledge structures show a striking stability over long periods of time, often persisting through such phases of fundamental change. This aspect of continuity is essential for the historical understanding of processes of conceptual innovation. The study of the long-term development of knowledge, including scientific and other forms of knowledge, is therefore central to the study of structural changes in systems of knowledge to which the Department is dedicated. In the period covered by this report, this study was pursued in four project contexts focusing, respectively, on spatial concepts, on cosmological models, on mechanical knowledge, and on modern physics. In addition, a new project context has been launched which traces such long-term developments in the life sciences.

Historical Epistemology of Space

The project on the long-term development of spatial concepts was conducted by a Junior Research Group jointly organized by the TOPOI Project Cluster and the Department. The group was headed by Matthias Schemmel and located at the Institute. It officially ended on October 31, 2012.

A starting point for the project was the observation that, in the history of Western epistemological thought, there is a long tradition of dividing spatial knowledge into a purely rational part, independent of any experience in the outer world, and an experiential part. While the historical epistemology of space shares the aim of identifying the different sources of spatial knowledge, it is based on a thoroughly developmental view on cognition. According to this view, experiential knowledge participates in the construction of cognitive structures which in turn constitute the basis for further experience.

A central focus of the group's research activities therefore concerned the interaction of experience and reflection in the historical development of spatial knowledge. Another conceptual focus was external, or material, knowledge representations, by means of which knowledge is transmitted from one generation to the next, but also between cultures, thus producing continuity in the historical development of thinking. Because the means of knowledge representation serve as tools for thinking, they may be modified in the course of being manipulated and applied to new purposes, thereby promoting innovation in conceptual structures.

Taking up these theoretical foci, a working-group volume under the title *Spatial Thinking and External Representation: Towards a Historical Epistemology of Space* has been prepared and is now close to completion. It contains the following contributions:

Members of the Eipo at 3,800 m navigating their way across the sacred Binal mountain, October 2012, Eipomek Valley, Province Papua, Indonesia.
Photo by Wulf Schiefenhövel.



– “The Historical Epistemology of Space” (Matthias Schemmel) provides a survey of the overall topic, specifying structures of spatial knowledge under different historical and cultural conditions and characterizing their epistemic status.

– “Spatial Concepts in Non-Literate Societies” (Martin Thiering and Wulf Schiefenhövel) addresses questions of universality and the culture-dependence of spatial thinking in societies that codify spatial knowledge almost exclusively by means of spoken language and joint action. These questions are approached by comparing spatial languages and practices in two independent non-literate societies, Eipo and Dene Chipewyan. The analysis of these two societies is largely based on fieldwork that had previously been carried out by the authors themselves.

– “The Impact of Notation Systems” (Peter Damerow) investigates changes in collectively shared spatial knowledge, when signs conveying arithmetical and semantic meaning emerge as a further means of knowledge representation. Such change took place in the early civilizations; this chapter pursues the development in Mesopotamia from the practical knowledge of surveyors at the beginning of the third millennium BCE to Babylonian geometry in the middle of the second millennium BCE.

– “Theoretical Reflections on Elementary Actions and Instrumental Practices” (William G. Boltz and Matthias Schemmel) addresses the independent emergence of theoretical knowledge on space in ancient Greece and China.

– “Cosmology and Epistemology” (Pietro D. Omodeo and Irina Tupikova) compares the different approaches in arguing for the centrality of the earth of the two major classical “authorities” on cosmology, Aristotle and Ptolemy, and discusses aspects of their reception up to early modern times.

– “Space and Matter in Early Modern Science” (Peter Damerow) argues that, notwithstanding their insistence on the priority of experience, the early modern scientists

had to take recourse to philosophical speculation in their attempts to formulate alternatives to replace the Aristotelian world system. In particular, the chapter examines attempts to distinguish matter from space by assuming that its essential property is impenetrability.

– “Beyond the Myth of Universal Space and Impenetrable Matter” (Jürgen Renn, Donald Salisbury, and Matthias Schemmel) delineates the fundamental changes in the concept of space brought about by the advanced formalism of twentieth-century physics, which enabled the integration of a growing corpus of experiential knowledge. In particular, the chapter describes the worlds of general relativity and quantum theory. As far as the physical processes and the objects they describe are concerned, these worlds overlap but are nevertheless incompatible in what concerns the basic concepts of space, time, matter, and force they imply.

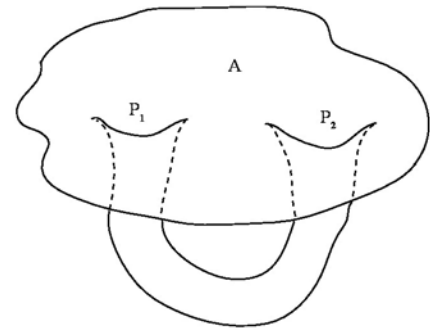

An “Intriguing kind of topological connectedness.” A depiction of a wormhole in an early discussion by John Wheeler at the Chapel Hill Conference in 1957 on the role of gravitation in physics.

In the period covered by this report, various results have been obtained through the project’s research activities. These results have either been documented in the working-group volume described above, or have been published in or presented at other places and venues. Because it is not possible to present all of the results here, a selection of interconnected examples are presented.

A common result of the different research activities concerns the interaction between different layers of knowledge in the historical development of spatial concepts. With regard to the empirical sources of knowledge and the ways in which knowledge is externally represented and transmitted, one may distinguish three layers of knowledge which we call elementary, practical, and theoretical, a distinction developed in the Department’s earlier work. The project has now provided crucial insights into the ways in which the structures of spatial knowledge from these different layers are related in their historical dynamics.

It could be shown, for instance, how research on elementary knowledge structures of animals and humans can be used to explain commonalities in the cultural practices of spatial orientation in societies that have developed independently of each other. One such elementary structure of knowledge may be referred to as the landmark model. Our comparative study of different cultural practices of orientation has shown how elementary structures provide the basis for elaborate practical knowledge systems, which develop through cultural accumulation into forms of expert knowledge that no individual standing outside the respective culture could ever have developed. One example is the Eipos’ network of toponyms by which they linguistically map their natural and cultural environment.

Under specific historical conditions, including the existence of a culture of disputation and arguably also a tradition of writing, systematic reflection on the linguistic representations of elementary spatial knowledge leads to theories of space and matter. Well-known examples are ancient atomism and Aristotelian physics, which build on different aspects of elementary spatial cognition and develop them into mutually contradictory worldviews.

The Greek case is traditionally considered to be unique, but the project has in fact studied parallel developments in ancient China. The analysis of passages in the *Mohist Canon* from Warring State China (around 300 BCE) and their comparison to Western sources has shown that the occurrence of elementary mental models in theoretical thinking on space is a cross-cultural phenomenon. The connection of such reflection with encompassing worldviews, by contrast, is a peculiarity of the Greek case and depends on the timing of specific theoretical traditions such as the construction of cosmologies on one hand, and the reflection on the meaning of words on the other. In addition to the contribution to the working-group volume, a monograph is in preparation that will offer a new translation and interpretation of the so-called scientific sections of the Mohist Canon (William G. Boltz, Matthias Schemmel).

In the context of the research activities on the transformation of concepts of space in twentieth-century physics, the role played by elementary knowledge structures was specified further. In particular, it has become clear that the landmark model is still effective in the context of highly formalized descriptions of non-Euclidean space-time, as the discussions about the role of coordinates in general relativity and the notorious “hole argument” show.

→ p. 41



→ p. 27

A world map produced in the late 1450s by the Venetian monk and cartographer Fra Mauro. The history of cartography is a common concern of the projects on the Historical Epistemology of Space and on the Transformation of Cosmology.

Transformations of Cosmology

For the last two years, a group of researchers from Department I has been studying the history of cosmology and astronomy, which, of all of the sciences, rely on the most stable forms of transmission and are therefore particularly suitable subjects for studying a long-term history of knowledge (Pietro D. Omodeo, Anna Holterhoff, Irina Tupikova, Matthias Schemmel, Matteo Valleriani, Miguel Ángel Granada, Jean Seidengart, Günther Görz, Klaus Vogel, Harald Siebert). The millenary history of these disciplines is nevertheless marked by epistemic changes, conceptual transformations, and technological shifts, for example, the introduction of geometric planetary models in antiquity and telescopic observation in the early modern period. Yet these scientific traditions were also characterized by continual attempts to crystallize and canonize methodologies, doctrines, and texts, as is evident by the continuity over the centuries in the transmission of Sacrobosco's *De sphaera*.

The research endeavor "Formation of Cosmological Knowledge in the Pre-modern Era: Transmission and Change in Diachronic and Transcultural Perspectives" was launched in 2012 as part of a newly founded joint research center with the Freie Universität Berlin, the CRC 980 "Episteme in Motion." Its aim is to investigate "conservative" aspects rather than "revolutionary" moments in the evolution of knowledge about the heavens (Pietro D. Omodeo). The research center itself deals with the stabilization and institutionalization of knowledge systems and the slow epistemic changes that took place within given historical frameworks.



Catalan world map (around 1450). This map, from Mallorca, shows Europe, Africa, and Asia. The grid, used for providing a geographical overview, is reminiscent of portolan charts.

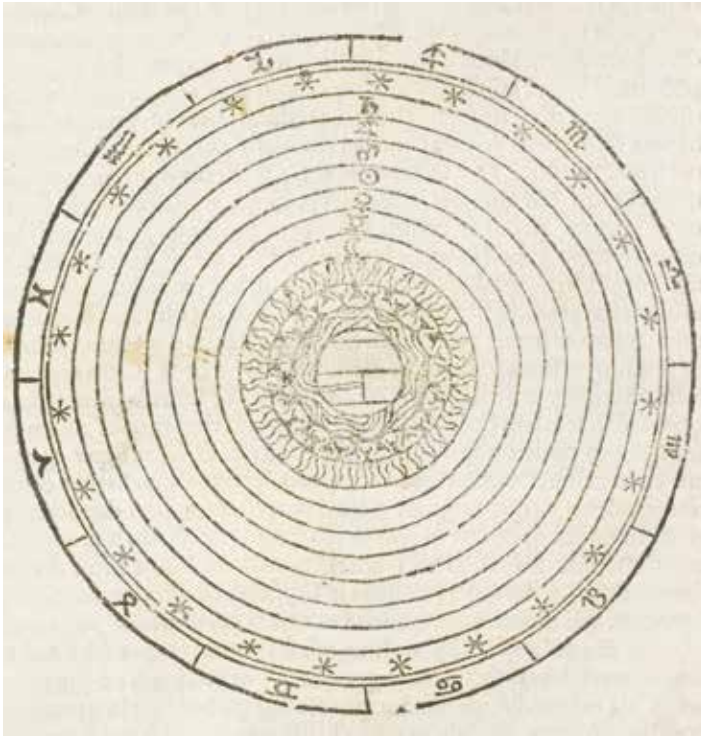

This figure, taken from an edition of Johann Sacrobosco's *De sphaera*, shows the four sublunar elements, the seven planetary spheres, and the eighth sphere of the fixed stars.

A series of workshops (organized by Anna Holtzerhoff) was dedicated to the legacy of Sacrobosco's *De sphaera*, its medieval and modern competitors, and its ancient and Arabic models, from Proclus and al-Farghani's elementary works to Grosseteste's *Sphaera* and later textbooks (Anna Holterhoff, Pietro D. Omodeo, Jochen Büttner, Matthias Schemmel, Matteo Valleriani, Günther Görz, Klaus Vogel, Johanna Biank). Discussions focused on elements of continuity and innovation in the argumentative strategies employed to support theses, such as the spherical form of the heavens and the centrality and immobility of the Earth, from classical Greek antiquity and Hellenistic times to the age of heliocentric and geoheliocentric planetary hypotheses. Another workshop dealt with the ties between spherical astronomy and geography established in early modern cosmography (Günther Görz, Matthias Schemmel, Klaus Vogel).

Discontinuities and breaks in the transmission of cosmological knowledge have also been investigated in the context of the collaborative research endeavor with the Humboldt University, the CRC 644 "Transformations of Antiquity," in which special attention was given to the transition from pre-Copernican conceptions of the heavens and the universe to those of the early modern period. In a series of publications and workshops, it could be shown that Renaissance eclectic cosmologists significantly contributed to the rediscovery of ancient conceptions (Pietro D. Omodeo, Jean Seidengart). In fact, in antiquity, a wide range of cosmological models was produced, which were mostly overshadowed during the late European Middle Ages by the preeminence of the geocentric, geostatic, and finite models.

Despite Averroistic criticism of the Ptolemaic geometrical models, which were deemed irreconcilable with the peripatetic cosmos of concentric material spheres, scholastic philosophy generally assumed a unified Aristotelian-Ptolemaic perspective, synthesized by Sacrobosco in the thirteenth century in *De sphaera*, which constitutes a focal point of current research (Pietro D. Omodeo, Matteo Valleriani). During the Renaissance, especially after Copernicus, eclectic views began to circulate. In this context, the rediscovery and reworking of ancient models alternative to the Aristotelian became fashionable. A historical investigation of astronomy during the Renaissance — an age of rapid development and heated disputes — has turned out to be particularly appropriate for comprehending transformations in cosmological thought as well as the changing relationship between mechanics and post-Copernican astronomy. With regard to the work of the mathematician and physicist Giovanni Battista Benedetti, it could be shown in particular that the relationship between mechanics and heliocentric astronomy in the sixteenth century was rather an interdisciplinary "alliance" than a form of "dependency" of the former on the latter, contrary to an old

but still influential view held, among others, by Koyré (Pietro D. Omodeo, Jürgen Renn).

Another focus of research is the impact of celestial novelties on theory, in particular the role of comets (Miguel Ángel Granada, Anna Holterhoff). In her doctoral thesis, Anna Holterhoff shows that the Renaissance discussion on comets went far beyond the academic discussions of the elites, because the invention of printing enabled a wide dissemination of astronomical knowledge, including in the vernacular.

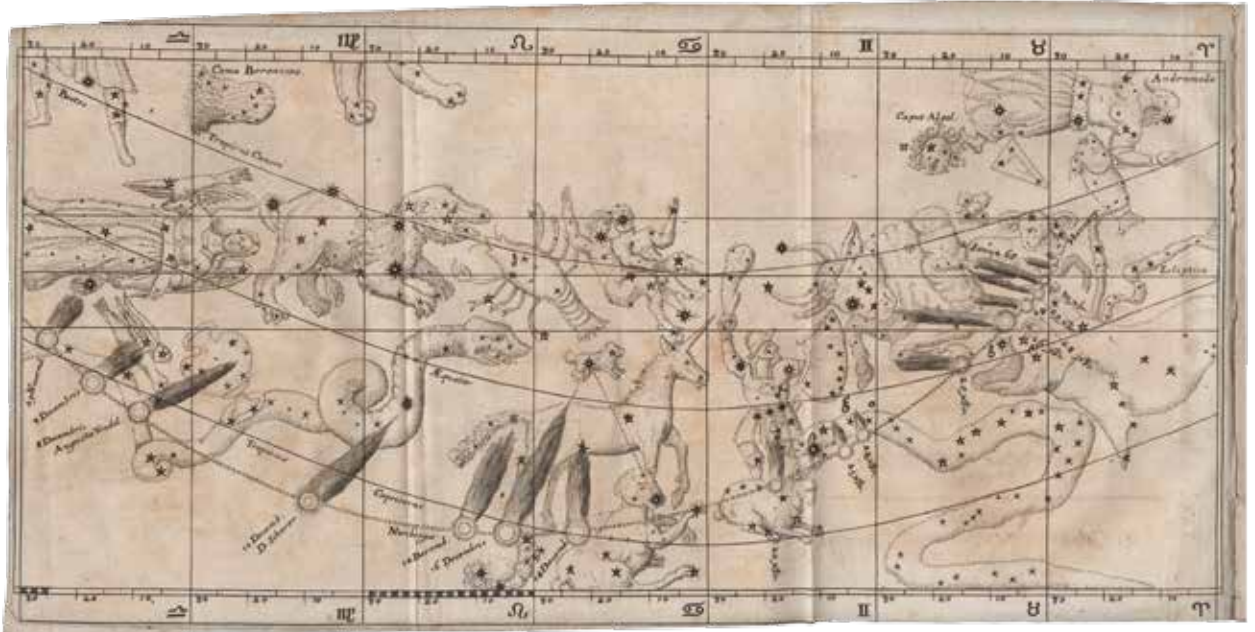

A monograph was dedicated to the early reception of Copernicus by different audiences (Pietro D. Omodeo). In this book, published in 2012, epistemological matters such as the definition of hypotheses — one of the most intriguing issues of Renaissance astronomy—are discussed, as are the relation between mathematical astronomy, natural philosophy, and theology in regard to disciplinary hierarchies. It is also shown that many mathematicians producing astronomical tables and ephemerides in the wake of Copernicus used their computational works as a convenient vehicle for presenting and defending innovative views ranging from heliocentrism and geoheliocentrism to natural philosophy. This book also examines the transformation of anthropology that accompanied the affirmation of a post-Copernican worldview. This investigation is based on rare and heterogeneous sources, ranging from mathematics to theology and literature. As a result, oversimplifications of earlier treatments have been superseded, in particular with respect to the reduction of the genesis, circulation, and influence of *De revolutionibus* to a unifying principle, a single “Copernican question.”

Comet ray moving through the constellation of the heavens in a chart from 1665.

Long-Term Development of Mechanical Knowledge

Mechanical knowledge is characterized by the continuity of its tradition from antiquity until the time between the end of the seventeenth and the eighteenth century when preclassical mechanics prepared the background against which modern physics emerged and fundamental categories, concepts, and views changed, disappeared, and were replaced with new ones.

In the last three years, research has been pursued in reference to ancient, late medieval, and preclassical mechanics, up to the scientific work of Isaac Newton. Further research endeavors explored the emergence from the eighteenth to the nineteenth century of the concept of “useful sciences” in relation to technological innovations.

The long-term development of mechanics is mainly investigated from the perspective of the relations between practical and theoretical knowledge and between scientific practice and its context. The overall objective of the project is to show the fundamental influence of social conditions and material culture on the large-scale structures of scientific development.

→ p. 45

Ramelli Agostino, *Le diverse et artificiose machine, Parigi, In casa dell'autore, 1588, 335 v. Use of a quadrant for calculating the ranges of artillery shots as a means of improving accuracy in the field.*



After having focused on the ancient world and the links that have emerged between mechanical practices and the foundation of theoretical mechanics in classical antiquity (Peter McLaughlin Jürgen Renn, Matteo Valleriani).), research on the history of mechanics has shifted its focus to later developments up until the ninth century in the Islamic world. Because of the crucial role of cross-cultural transmission processes in this stage of the development of mechanical knowledge, this research was conducted in the context of the project “Globalization of Knowledge and its Consequences.”

The transmission of Arabic science to the Latin world is closely related to the emergence of novel perspectives on science and, specifically, on mechanics in reference to natural philosophy in the context of the emergence of scholastics. This period was one of the main foci of investigations of the long-term development of mechanics. A central topic of research was the question of how far philosophical reflections in the thirteenth and fourteenth centuries furthered the re-emergence of a science of mechanics that incorporated practical knowledge as a science investigating natural phenomena. The appropriation of Aristotelian metaphysics and physics in the thirteenth century suggested the question to which extent the rational soul could investigate nature inde-

pendently of any contemplation of God and intervene in nature with the help of artificial means. This study, focusing on the commentary works of Thomas Aquinas, revealed how a theoretical and practical science of mechanics re-emerged and at the same time offered an interpretation of the relation between “art and nature” inherited from the Aristotelian doctrines during the thirteenth century (Matteo Valleriani).

At the core of the new mechanics was the medieval science of weights. In a book-length study dedicated to the equilibrium of a balance — a key problem of the science of weights — its history and role in the emergence of preclassical mechanics has been revisited (Peter Damerow, Jürgen Renn). One of the central concepts of the science of weights, referring to the positional effect of a weight, could be traced back to the Arabic sources of the work of Jordanus de Nemore, on the one hand, and to the emerging context of scholastics, on the other. In addition, the line of transmission of the science of weights to early modern preclassical mechanics could be reconstructed in greater detail. It was also shown that Galileo’s influential concept of “momento” was an adaptation taken from Giovanni B. Benedetti’s work on mechanics, which in turn had its roots in a critical re-evaluation of Tartaglia’s exposition of the medieval science of weights. Whereas it was previously unclear whether Galileo was actually familiar with Benedetti’s work, it could be shown that he discussed it in detail with his patron and Benedetti’s adversary, Guidobaldo del Monte. The study thus also provides an illustration of the crucial role that controversy plays in shaping scientific concepts.

The establishment of new scientific practices during the late Middle Ages did not take place without theological opposition. In consequence of this conflict, nominalistic tendencies as well as refinements of logical methods for investigations (*calculatores*) were developed. An important turning point was the development by Nicole Oresme of diagrammatic representations for the quantification of qualities, which turned out to deliver crucial instruments for later preclassical mechanics (Matthias Schemmel). How such methods were actually transmitted from the scholastic tradition to the period of Galileo Galilei and Thomas Harriot remained, however, controversial. A dissertation project was dedicated to a detailed study of Thomas Alvarus’s *Liber de triplici motu* (1509), which was consulted, among others, by Thomas Harriot and thus constitutes a missing link between scholastics and the preclassical period. The analysis of Alvarus’s book and its institutional and intellectual contexts has now demonstrated how such methods were transmitted as an enrichment of Aristotelian physics and natural philosophy in the fourteenth and fifteenth centuries (Stefan Paul Trzeciok).

The early modern period was the era of preclassical mechanics, which has been a major research subject for several years. Preclassical mechanics was concerned mainly with the investigation of isolated problems emerging from contemporary technological challenges such as the pendulum, the fly wheel, the trajectory of cannonballs,



Title vignette of Apianus’ edition of Jordanus’ *Liber de ponderibus* displaying a scholar and a practitioner. The scholar explains the functioning of a steelyard according to Aristotelian principles.

and the role of weight in machines and constructions. It addressed these problems on the basis of heterogeneous conceptual frameworks inherited from antique and medieval traditions. A pivotal concept of the epistemological framework developed for the analysis of preclassical mechanics is the notion of “challenging objects,” which has meanwhile also been more widely applied to the understanding of structural changes in systems of knowledge. This framework and its wider range of applications was discussed in the context of the international workshop “Challenging Objects,” which was organized in 2010 in the framework of the Max Planck International Research Network History of Scientific Objects (Jochen Büttner).

A research endeavor concerned with the emergence of ballistics in the sixteenth century has analyzed mechanisms of the accumulation of practical knowledge (Matteo Valleriani). In reconstructing the context of Niccolò Tartaglia’s *Nova scientia*, it became clear how the emergence of theoretical ballistics represented a way of economically synthesizing accumulated data produced and recorded from immediate experience with gunpowder artillery. A crucial boundary object between theoretical and practical knowledge was a mathematical instrument, the quadrant. When Tartaglia published his treatise in 1537, it had been in use among bombardiers for more than a century. It could be shown how theoretical ballistics emerged as the result of a sharing process, mediated by this instrument, between the accumulated experience with artillery, on the one hand, and the Aristotelian theory of motion, on the other.

Salomon de Caus, *Von gewaltsamen Bewegungen*, 1615. The construction of a hydraulic organ.

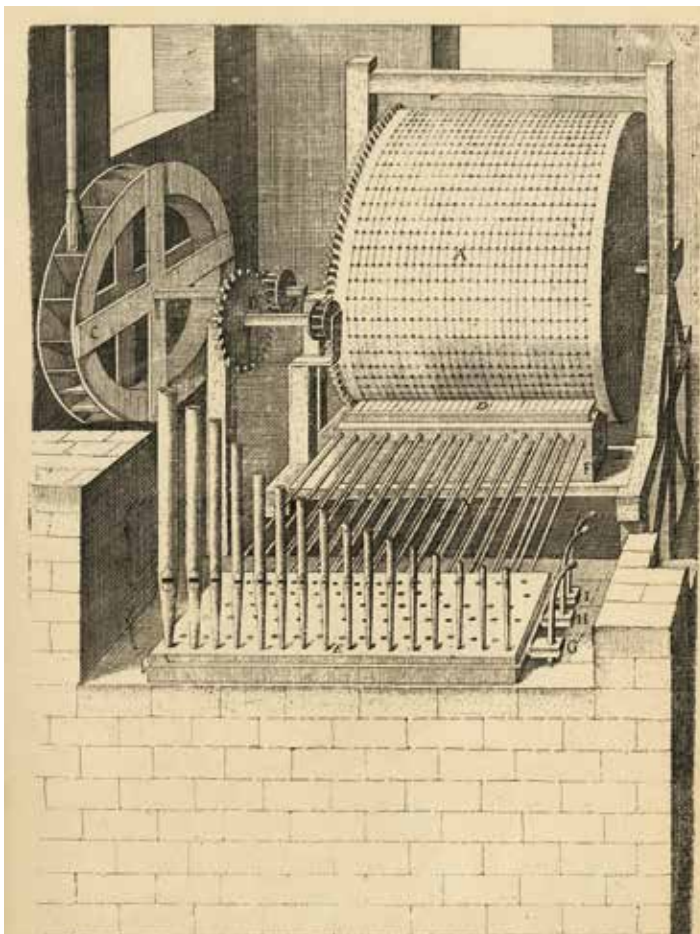

The roots of Galileo’s science in the practical knowledge of his time and his background as an engineer-scientist was analyzed in depth in a monograph entitled *Galileo Engineer* (Matteo Valleriani). This work received two awards: the Pictet Prize in 2010 and the Paul Bunge Prize in 2011. Related studies were able to show how practical knowledge such as the knowledge embedded in the construction of ear trumpets and hydraulic organs deeply influenced the emergence of modern acoustics and pneumatics based on a new theory of the four elements (Matteo Valleriani). Moreover, Galileo’s most celebrated theoretical achievement, his new theory of motion published in the *Discorsi* (1638), was rooted in the practical knowledge of his time. This was shown in a book-length study entitled *Galileo’s Challenges: The Origins and Early Conceptual Development of Galileo’s Theory of Motion*, which is currently being prepared for publication (Jochen Büttner, Boston Studies 270, forthcoming).

A comprehensive analysis of preclassical mechanics and its transformation into classical mechanics is also being prepared for publication as the conclusion of the Boston Studies series on *The*

Historical Epistemology of Mechanics (Boston Studies 271, forthcoming, Rivka Feldhay, Jürgen Renn, Matthias Schemmel, Matteo Valleriani). This publication integrates the results of the completed research on “Knowledge and Belief” dealing with the scientific practice in the Order of the Jesuits. The scientific work of the Jesuits has also been the subject of two further case studies: one on the practice of teaching and diffusing knowledge by means of the recitation of physico-mathematical problems in public (Rivka Feldhay); the second on the impetus-based physics of the Jesuit natural philosopher and mathematician Honoré Fabri (Michael Elazar). It has been shown, in particular, how Fabri, while remaining loyal to a general Aristotelian outlook, managed to reinterpret the mental model of “impetus” in a way that assimilates more recent approaches by Galileo and Descartes.

Since 2005, the theoretical framework for studying the relation between modern and ancient science, as well as numerous case studies illustrating this relation, were elaborated in cooperation with the joint research center at the Humboldt University, the CRC 644 “Transformations of Antiquity,” and in particular in the context of the project “Transformations of Ancient Modes of Thought: Technology, Mental Models, and Deductive Reasoning.” After the research on “Pratolino: The History of Science in a Garden” concerning hydraulics and pneumatics was completed (Matteo Valleriani), the focus was set on architecture and structural mechanics (Antonio Becchi). Its main topics were the reception history of Vitruvius’s *De architectura* between the sixteenth and the twentieth centuries, the relation between practical and theoretical mechanics on the building site, and the influence of the *Mechanical Problems* of pseudo-Aristotle on the work of architects and engineers. The research has shown how, in spite of the emergence of mathematical theories on strength of materials and on structural mechanics in the seventeenth century, the rules of the art of the architects and of master masons were stably followed on building sites during the next two centuries.

Bernardino Baldi (1553–1617), *De le Vite de’ Matematici libri due*, manuscript (1575–1596), Centro Internazionale di Studi Rosminiani (Stresa, Italy). This monograph is the first completely dedicated to biographies of mathematicians.

In 1707 an abridged version of the *Vite* prepared by Baldi himself was printed as *Cronica de matematici, ovvero Epitome dell’istoria delle vite loro*.

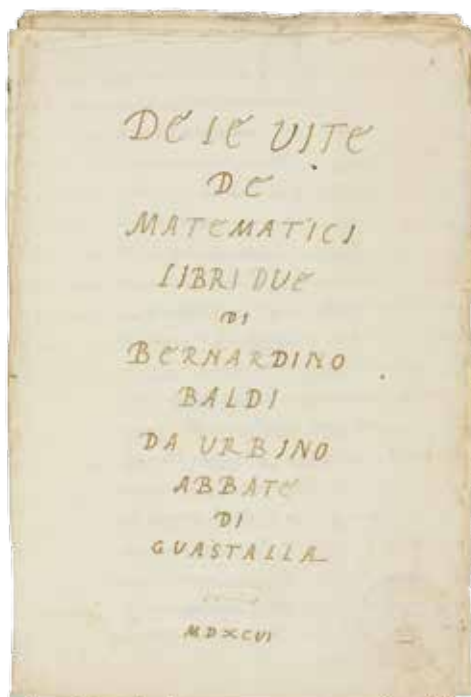

Related studies dealt with early modern theories of collision and the role of mathematics in this period (Scott Hyslop, Bernardo Mota). A German translation of Newton's *Optics* and an English/Latin edition of the same work have been completed (Volkmar Schüller). The reconstruction of the long-term development of mechanical knowledge will continue over the coming years, with a focus on the emergence of analytical mechanics. The first international workshop dealing with the analytical turn of the sciences was held in 2012 (Alexander Blum, Massimiliano Badino, Pietro D. Omodeo, Christoph Lehner, Helmut Pulte). A network of Italian, German, and French institutions centered in Urbino was set up with the aim of encouraging research collaboration on Archimedes in the Renaissance (Antonio Becchi, Daniele Napolitani, Romano Nanni). The results of the two workshops are currently being prepared for publication in the Edition Open Access.

A further research endeavor scrutinizes the education and training of so-called hybrid experts, that is, experts recruited by the Prussian State Administration from the physical and mathematical classes of the Royal Prussian Academy of Sciences while establishing technical departments, such as a department of mining and smelting works (Ursula Klein). The combination of academic sciences with elements of locally embedded practical knowledge has been identified as the fundamental step in the process of emergence of the later technological and engineering sciences. This research thus provides a fundamentally new understanding of the interdependence between the modern laboratory-based sciences and the emerging technological and engineering sciences.

An eighteenth-century mine combined with smelting works. From Andreas Schlüter, *Gründlicher Unterricht von Hütte-Werken*, Braunschweig (E. W. Meyer), 1738.

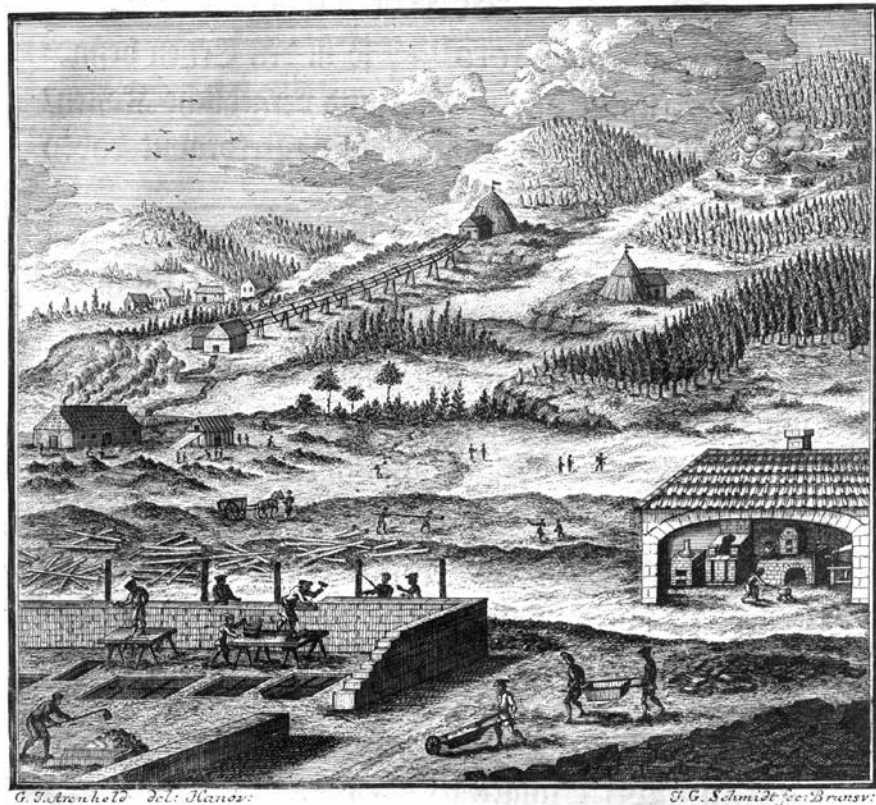

Reorganizing Knowledge in Modern Science

The History and Foundations of Quantum Physics

Over the last six years, a central research question addressed in Department I was the process of reorganization and reinterpretation of mechanical knowledge in the course of the quantum revolution from 1900 to 1930. This process was triggered in part by conflicts between theoretical expectations and experimental results, but also, importantly, by the difficulty of integrating recently established physical theories such as electrodynamics and thermodynamics into the mechanical worldview. These borderline problems of mechanics necessitated a reorganization and re-evaluation of those controversial concepts where mechanics overlapped with more recent physical theories. Central to this process of re-evaluation was not only a large amount of uncontroversial empirical knowledge accumulated over a long period of time, but also the persistence of certain theoretical structures and methods. Theoretical physicists were confronted with critical decisions about which concepts and theoretical structures could be maintained in the emerging theory and could thus serve as a guide for the development of the theory.

As in the case of relativity, which was studied extensively from 1994 to 2005, in the quantum revolution high-level and abstract structures survived, although frequently with a new physical interpretation. Unlike the case of relativity, a consensus about the physical reinterpretation of the abstract structures was not easily attained. Famous dissenters, such as Einstein and Schrödinger, while accepting the new theoretical structure, disagreed about its meaning and its connection to the traditional mechanical worldview. Later on, the establishment of quantum field theory, including unification with the theory of relativity, has turned out to be at odds with the traditional demands on an interpreted physical theory. These disagreements have persisted up to this day, even though quantum mechanics by all counts is a highly successful predictive theory.

The research project on the history and foundations of quantum physics ran from October 2006 to September 2012 (Christoph Lehner, Jürgen Renn). It was a joint initiative with the Theory Department of the Fritz Haber Institute, originally funded for five years by the Strategic Innovation Fund of the President of the Max Planck Society. It was extended by another year in view of the substantially broadened publication program, which was already outlined in the previous report and is described in detail below.

The project has arrived at a deeper understanding of the genesis and the development of quantum physics, using the tools of historical epistemology that have been developed in Department I. The project thus focused on the long-term history of the process of knowledge restructuration, stressing the continuity of practices and structures. Unlike the relativity revolution, the development of quantum physics was a communal effort whose nature cannot be captured by a biographical approach that focuses upon a few central figures: careful attention must be paid to the broader community of researchers and to the network that allowed them to achieve what no single researcher could do alone.

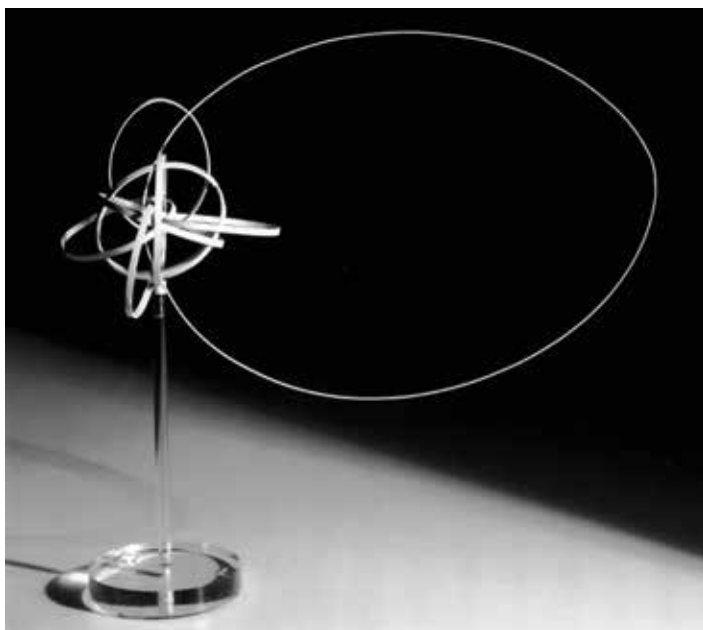

Model of a sodium atom by Lawrence Bragg based on calculations done by Douglas Hartree. The model is from 1926, but still represents Bohr's theory of atomic orbits. © Science Museum London.

make available a wide array of sources for the history of quantum physics in the ECHO environment (Carmen Hammer). Part of this endeavor was the digitization by the Institute's library of the complete Archives for the History of Quantum Physics, an extensive collection of sources compiled and microfilmed by the American Philosophical Society. The digitized material is accessible to cooperating researchers on the project's website. A virtual archive of Erwin Schrödinger's papers, which are in the possession of his daughter, Ruth Braunizer, was developed (Julia Damerow, Martin Jähnert). Editorial work has benefitted from an exchange with the Collected Papers of Albert Einstein Project, in particular regarding Einstein's writings and correspondence from 1922 to 1923 (Diana Kormos-Buchwald).

From its inception, the project undertook extensive efforts at establishing an international network of historians, philosophers, and physicists working on the history of quantum physics: through conferences and workshops; through the project's website and mailing list; and by providing an electronic working environment for accessing digitized source material. At the same time, the project's results were presented to a wider public, for example, through teaching at Berlin universities and collaborating with German high schools, by holding a semester-long joint colloquium at the Physics Department of the Freie Universität Berlin, and by initiating a new historical section in the renowned physics journal *Annalen der Physik* (Dieter Hoffmann, Christian Joas). The third meeting in a series of conferences, launched by the project in 2007 to strengthen the international network of researchers working in the history of quantum physics, was held in Berlin in 2010. Its proceedings will be published in early 2013 in the *Proceedings* series of the *Max Planck Research Library for the History and Development of Knowledge*. Two workshops on the *Historical Roots of Quantum Gravity Research* were held in Pasadena, California, in 2010 and at the Institute in 2011. A conference on the history of modern physics for graduate students and early career scholars was co-organized by members of the project and held at the American Institute of Physics in College Park, Maryland, in 2011. Two workshops, on quantum

This challenge necessitated a large-scale collaborative research project, unusual in the history of science not only in its size, but also in its interdisciplinary character. Bringing together researchers with diverse backgrounds, the project achieved a comprehensive account of the quantum revolution. The work drew upon extensive archival records of correspondence, manuscripts, and notebooks. To make possible a large-scale history of this kind, a coordinated effort has been made in close cooperation with the IT Department to collect, digitize, and

theory and on statistics, were held at the Institute in 2012, initiating research collaborations with scholars in Israel and Urbino, Italy, respectively. The project co-organized two meetings of the series *New Directions in the Foundations of Physics* (in 2011 and 2012) in Washington, DC, adding sessions on the history of modern physics.

The research results of the project are in the final stages of publication and will appear in an open access format in three volumes in the *Studies* series of the *Max Planck Research Library for the History and Development of Knowledge*. As the central publication of the project, a working-group volume describes the development of quantum mechanics as a long-term process of theory change (Christoph Lehner, Christian Joas, Jürgen Renn). It emphasizes the continuity of scientific methods and structures through the fundamental changes in the mechanical world picture since the nineteenth century. This book bundles the individual research results of the members of the group into a coherent whole, at the same time achieving a legible survey of the development of quantum mechanics and filling a void between thematically focused technical accounts and popular presentations that do not represent the current historical state of the art. The individual contributions to the volume exist in draft and are currently being edited for coherence and complemented by synthetic and interpretive essays.

The second volume (Massimiliano Badino, Jaume Navarro) analyzes early textbooks of quantum theory and their role in establishing and promoting the theory. It explores the ways in which physics textbooks reacted to the novelties of the emerging quantum physics and how scientific revolutions affect the pedagogical process of knowledge transmission. The volume is in production.

The third volume (Giuseppe Castagnetti, Jürgen Renn) addresses the role of scientific institutions and networks in the development of quantum theory. It consists of case studies of the major centers where the development of quantum physics took place: Arnold Sommerfeld's theory institute in Munich (Michael Eckert), the physics and mathematics institutes at Göttingen (Arne Schirrmacher), and the tightly knit network of state and academic research institutes in Berlin (Dieter Hoffmann). It also encompasses a new examination of the development of traveling, post-doctoral fellowships into a mainstay of advanced physics education (Alexei Kojevnikov).

One of these centers is the Kaiser Wilhelm Institute (KWI) for Physical Chemistry and Electrochemistry (now the Fritz Haber Institute), a comprehensive history of which was published in 2011, based on a joint three-year research project with the Fritz Haber Institute (Bretislav Friedrich, Dieter Hoffmann, Jeremiah James, Thomas Steinhauser). A similar volume has been dedicated to the history of the KWI for Chemistry (Carsten Reinhardt, Horst Kant). Further research tied these specific cases to a broader view of the success of the Kaiser Wilhelm Society and especially the Max Planck Society in supporting excellence in scientific research well into the postwar era (Horst Kant, Jürgen Renn).

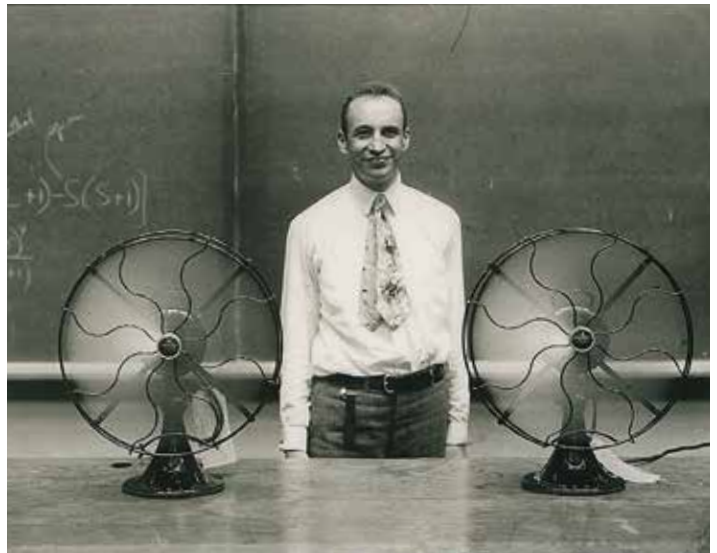

John Hasbrouck van Vleck, author of one of the first textbooks on quantum mechanics and spectroscopy, around 1930.

Work in this thematic context also included study of the system of science communication in Germany during the 1920s up into the 1950s (Arne Schirmacher), the (re-)emergence of mathematical physics as a distinct specialty (Georg Kopsky), and considerations of both the links and the differences between institutions supporting advanced physics research in disparate national contexts, including early twentieth-century Germany and Greece (George Vlahakis), contemporary Germany and China (Harriet Cong Wang), the Soviet Union (Alexei Kojevnikov), and in the context of the Cold War (Dieter Hoffmann).

While the project in its original form ended in September 2012, the Department will continue its research on the history of quantum physics in several smaller projects, including a collaborative project on the *History of Self-Organizing Processes in Physics and Chemistry Seen through the Nobel Prizes: Complexity, Reduction, and Emergence*; a collaboration with the foundation for the Lindau Nobel Laureate Meetings; and a collaborative project together with the University of Haifa and the Hebrew University, Jerusalem, on *Probability in Classical and Quantum Mechanics*.

Overview of the Research Results

One central research result of the project is the insight that the quantum revolution, even though it implied one of the most momentous transformations of mechanical theory since its beginnings, cannot be understood as a wholesale replacement of one conceptual system by another. Rather, quantum mechanics was the *reinterpretation* (Heisenberg's German term was *Umdeutung*) of the concepts of classical mechanics within a new framework, which left intact not only most of the established empirical knowledge, but also major parts of the formal structure of the conceptual framework. A central role in this process of transformation was played by a small number of mental models, such as the Bohr atom or the light quantum, that took on a role analogous to the "challenging objects" as defined in previous research of Department I on the transformation of Aristotelian mechanics. As in the case of the challenging objects of Renaissance mechanics, these mental models served a dual role of bundling a large and growing amount of empirical knowledge and posing the challenge to find a consistent theoretical description for this empirical knowledge, which would otherwise have been unrelated. These challenges posed to a theoretical explanation have been studied in a set of research projects on problems of the old quantum theory. The findings of these projects were central to the reconceptualization of the quantum revolution offered in the group volume on the history of quantum mechanics.

The historical roots of quantum physics reach back to the nineteenth century and were the subject of discussions and joint work with guest scholars at the Department; topics included, for example, wave optics (Jed Buchwald); Mach's history of mechanics (Gereon Wolters, Giora Hon); Duhem's thermodynamics (Stefano Bordoni); statistical mechanics (Massimiliano Badino); celestial and analytical mechanics (Massimiliano Badino, Michiyo Nakane); the early work of Erwin Schrödinger on dielectric phenomena in solids (Christian Joas, Shaul Katzir). The further development and ramifications of quantum physics have been studied by numerous individual investigations, with a particular emphasis on condensed-matter physics and material science (Anja Skaar-Jacobsen, Georges Waysand, Johannes Knolle, Xinguo Ren, Patrick Rinke, Mathias Scheffler, Charles Midwinter, Michel Janssen, Kostas Gavroglu, Philip Kao, Shaul Katzir).

The statistical strand of quantum research was investigated in studies on Planck's theory of black-body radiation and the problem of finding a quantum theory of the ideal gas, in an analysis of the way the quantum hypothesis changed the understanding and the application of the conceptual tools of statistical mechanics (Massimiliano Badino, Daniela Monaldi).

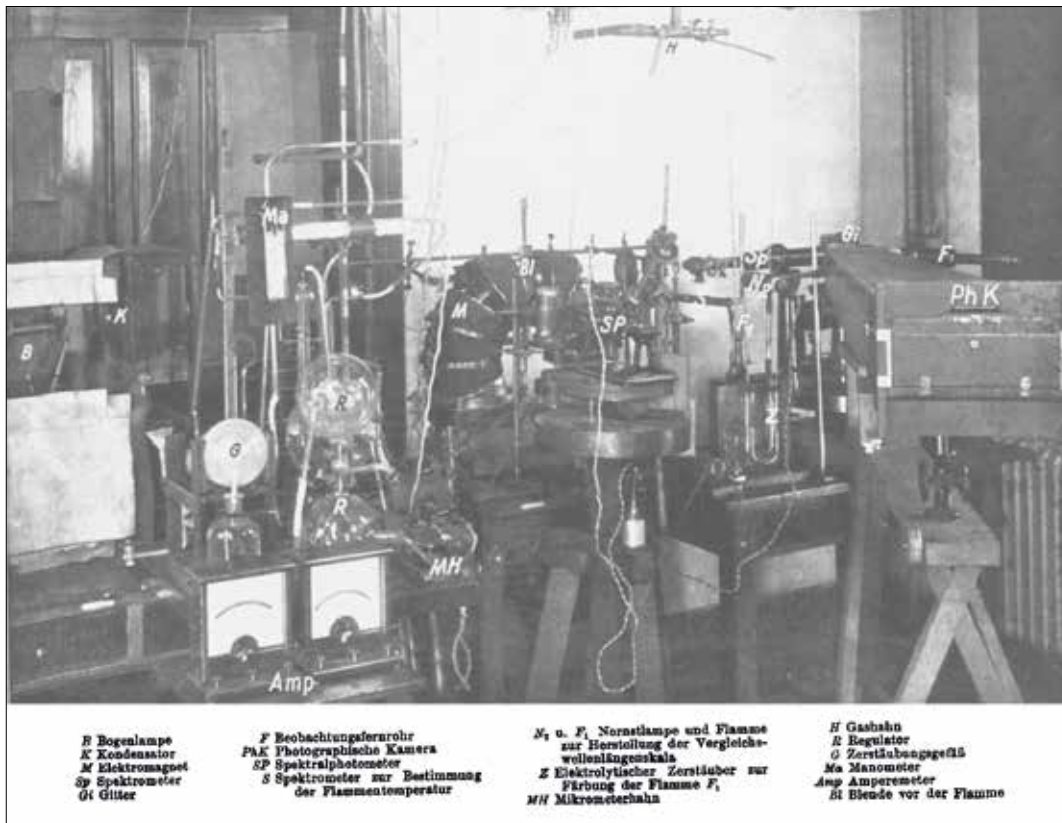

Experimental setup used in 1915 by Hermann Senfleben, PhD student of Rudolf Ladenburg in Breslau, to measure dispersive phenomena around the spectral lines of metallic vapors.

The radiation theoretical strand of quantum research was investigated in studies of the long-term history of optical dispersion (Marta Jordi Taltavull) and of the development of the correspondence principle (Martin Jähnert), both of which were essential for the formulation of matrix mechanics, and a study of the development of the light quantum hypothesis (Alexander Blum), which was essential for the ideas giving rise to wave mechanics. These three studies have analyzed different strategies of developing a quantum theory of the interaction of light and matter. Thereby, they have highlighted challenges posed to the persistent conceptual structures of classical physics and the process of reorganization of established knowledge necessitated by them.

The study of experimental research within quantum theory focused on experiments concerning the interaction between electromagnetic radiation and matter at the beginning of the twentieth century (Shaul Katzir) and on the technical tools employed in key experiments (Dieter Fick, Horst Kant). Both studies have contributed to the understanding of the development and importance of experimental knowledge within the old quantum theory.

Mechanical models and their role in research on atomic physics were at the center of a research activity that contributed to the understanding of the planetary model of the atom as pertaining to a tradition of shared knowledge independent from the old quantum theory (Arne Schirrmacher).

The study of Schrödinger's notebooks was continued, with a focus on his attempts to find a relativistic wave equation and a correct representation for the interaction of matter and electromagnetic field (Alexander Blum, Christian Joas, Christoph Lehner, Jürgen Renn).

Another novel result of the project's research is the realization that in the 1920s the rise of quantum mechanics and the beginnings of a quantum theory of the electromagnetic field were so closely entwined that the traditional historiography of quantum mechanics, which excludes the beginnings of quantum electrodynamics, cannot offer a complete understanding of the development of either theory. The project's work on early quantum field theory was continued through a detailed study of the problems that beset early quantum electrodynamics in the years after 1927, and of the proposals how to circumvent them (Alexander Blum, Christoph Lehner). Another study investigated how, despite these difficulties, quantum field theory continued to be used as a theoretical framework throughout the 1930s, and even achieved notable successes, such as the solution of the infrared divergence problem and the formulation of the spin-statistics theorem (Alexander Blum).

A further result concerns the debates about the interpretation of the new quantum mechanical formalism within the core group of quantum physicists between 1925 and

1928. The project concluded that these debates about suitable approaches are not to be understood as debates about a detached concept of the true nature of physical objects, but rather as debates about promising research strategies (Martin Jähnert, Christoph Lehner).

Another result of the project was the recognition that the development of quantum mechanics, including its interpretation and its use, relied essentially upon its applications in established research fields such as chemistry, solid-state physics, and nuclear physics (Jeremiah James, Christian Joas). As an exploration of the widening applications of quantum theory, several investigations have been conducted that deal with the emergence of physical subdisciplines during the twentieth century as well as with processes of knowledge transfer between these subdisciplines (Jeremiah James, Christian Joas, Edward Jurkowitz, Horst Kant, Dieter Hoffmann, Leyla Joaquim, Joan Bromberg, Indianara Silva).

Friedrich Krüger's 1916 representation of Bohr's model of the hydrogen molecule as a gyroscope. The hope that a quantum theory of the motion of a gyroscope would account for a wide number of phenomena, from absorption lines to optical dispersion and specific heats, was not fulfilled before the development of quantum mechanics.

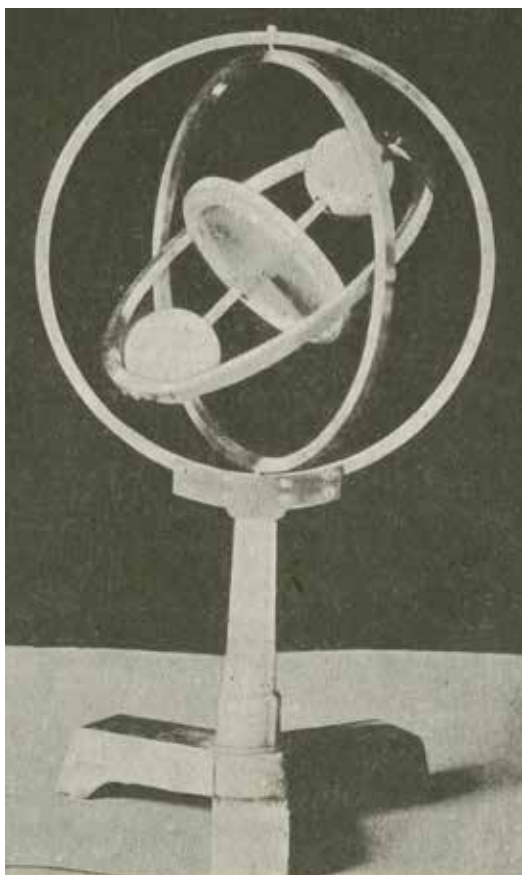

The History of Quantum Gravity Research

In 2009, a working group (Jürgen Renn, Donald Salisbury, Matthias Schemmel, Kurt Sundermeyer, Alexander Blum, Dean Rickles, John Stachel) was established with the aim of studying the borderline problems at the interface of quantum theory and (general) relativity, which began to capture the attention of physicists after those two theories had emerged from similar conceptual clashes within classical physics, and from the consequent restructuring of the knowledge it contains. The search for a successful theory of quantum gravity that can bridge this divide has been going on for almost a century, for a long time entirely free from any empirical manifestations of the divide. This search offers a unique opportunity to test and refine dynamical models of knowledge development.

It had already been observed in the study of quantum mechanics that classical mechanics itself was in fact developing while and even because of the genesis of quantum mechanics. Similar developments could be observed in the context of quantum gravity research, where the difficulties at their boundaries led to reflective reorganization within the two maturing theoretical frameworks, quantum field theory and general relativity.

Thus, for instance, in 1930 while in effect creating a space-time background-independent formalism that would be amenable to quantization, Léon Rosenfeld provided both a justification and a theoretical basis for tools that were then being deployed in constructing quantum electrodynamics (Don Salisbury).

The development of classical constrained Hamiltonian dynamics by Rosenfeld, Tsung-Sui Chang, Peter Bergmann, and Paul Dirac also represents an internal theoretical consolidation process in classical relativity that was motivated by the perceived need to create a suitable framework for implementing general covariance in quantum gravity. Several studies have either been published or are in production (Jürgen Renn, Dean Rickles, Don Salisbury). They draw in part on a series of interviews conducted by Dean Rickles and Don Salisbury in March 2011 with several key contributors in this development in the 1950s and 1960s. The disputed meaning of observables in general relativity features in much of this work.

Similarly, a study has revealed how the development of a covariant formulation of quantum gravity closely followed and interacted with developments both in general relativity and, even more important, in quantum field theory, where Richard Feynman's research in quantum gravity led to the resolution of a difficulty (the unitarity problem) in nuclear field theory. This close association with developments in quantum field theory, which ensured that the theory was always well-defined (as opposed to other, more programmatic approaches), led to the first formal proof of the incompatibility of quantum theory and gravity in 1974 (Alexander Blum).

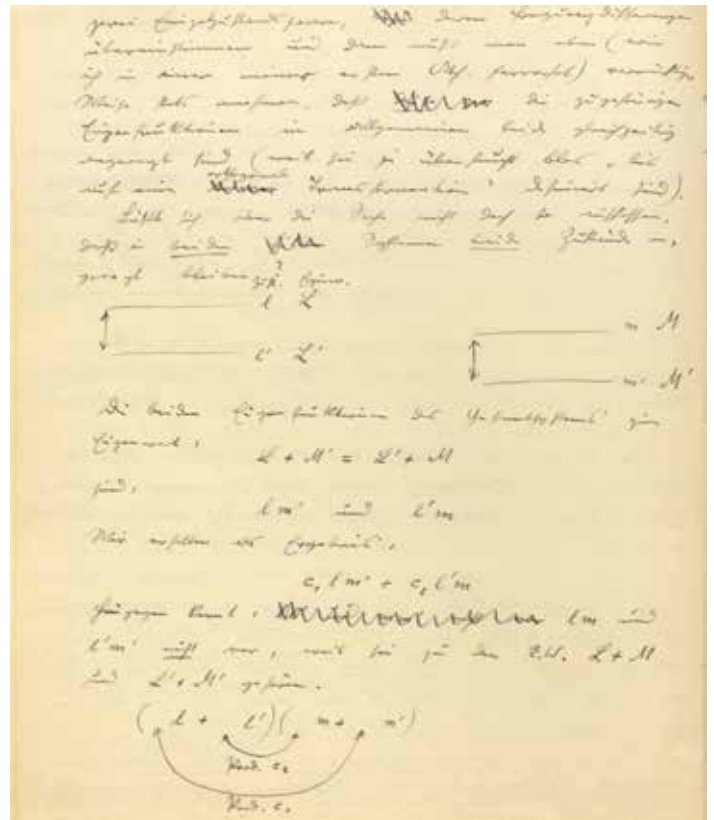

A page from Schrödinger's research notebook of 1926 entitled "Undulatorische Statistik I" showing his first encounter with the phenomenon he would later call entanglement.

Paul Dirac and Richard Feynman in conversation at the 1962 Jablonna meeting.



Cecile DeWitt-Morette and Bryce DeWitt at the 1962 Jablonna, Poland, meeting on relativistic theories of gravitation.



This research was accompanied by the two workshops already mentioned on the *Historical Roots of Quantum Gravity Research*, where relevant sources were identified, studied, and discussed in an interdisciplinary group of ten (2010) and twenty-five (2011) researchers, respectively. Among the discussed sources was the report of the 1957 Chapel Hill conference, arguably the event where discussions on quantum gravity entered the American physics mainstream. In 2011, the original report, compiled by Cécile M. DeWitt, was converted into a book (Dean Rickles). A further volume of early sources of quantum gravity based on the discussions of the workshops and accompanied by a historical introduction is in preparation (Alexander Blum, Dean Rickles).

A second focus of the group's research has been an in-depth conceptual study of the interfaces between quantum theory and general relativity, especially addressing the question of how the discrepancies between the two theories were and are manifested in some of their key notions. The first major investigation in this direction is concerned with the equivalence principle and the reinterpretations of the classical notion of action, which played important roles as heuristic principles in the development of general relativity and quantum theory, respectively (Alexander Blum, Jürgen Renn, Don Salisbury, Matthias Schemmel, Kurt Sundermeyer).

A similar conceptual approach led to a re-evaluation of the dominant contemporary canonical approach to quantum gravity, as a consequence of recent progress in the understanding of the symmetries generated by constraints in the classical canonical formalism (Jürgen Renn, Don Salisbury).

Reorganizing Knowledge in the Life Sciences

A group of studies analyzes conceptual transformations within the life sciences under analytical and historiographical perspectives similar to those of the research project on the reorganization of physical knowledge. They aim at understanding the shift from biological theories based on more or less stable entities (genes, organisms, populations, and species) and their dynamics — the “classical phase of biology” — to those focusing on complex systems, contextual information, computational logic, and non-linear dynamics in the areas of evolutionary theory, systems biology, and synthetic biology.

The Federal State of Mecklenburg-Vorpommern has funded a collaborative project with the Center for Logic, Philosophy and History of Science at the University of Rostock in the context of its program of excellence “Transformation of Scientific Knowledge in the Life Sciences” (Olaf Engler). Within the scope of the cooperation, a dissertation project has dealt with the transformation of biological knowledge due to the Darwinian revolution (Sebastian Zacharias). It has tried to answer the question of how this transformation can be understood in a way that accounts for both theoretical discontinuity and empirical continuity. It has also taken systematically into account their reception and appropriation by different audiences at different degrees of depth of understanding, evaluating the relevant contemporary professional and popular literature, as well as the extensive secondary literature on Darwin. This account of the Darwinian revolution is anchored in the framework of an historical epistemology referring to the transformations of systems of knowledge as multilayered structures. The study also relies on recent work by historians and philosophers

of science which emphasizes the role of narration in scientific explanations. In the period covered by this report, a new, revised edition of Wolfgang Lefèvre's account of the Darwinian revolution has also been issued.

More recent transformations of the life sciences can, as in the case of the Darwinian revolution, also be understood in part as a response to the growth of empirical knowledge, and in particular to changes in the data structure, often identified as "big data." But they also reflect the importance of new methods and technologies, especially in the areas of computing and molecular methods, including nanotechnologies. Aspects of these transformations have been studied, also with regard to parallel developments in the humanities and in particular in the history of science (Manfred Laubichler, Jane Maienschein, Jürgen Renn). As a result of these transformations of the life sciences, new mental models and theoretical constructs emerge that form the basis of a computationally enabled theory of biology with a focus on complex systems theory at its core, including new interpretations of traditional biological concepts, such as "system," "regulation," "network," and "synthesis."

In addition, there is now an increasing body of solid empirical and theoretical work that points to the wide range of phenomena (from medicine to economics and from the humanities to the social sciences) that can be productively understood from an evolutionary point of view. Some of this work has recently been reviewed in the context of an Ernst Strüngmann Forum on Cultural Evolution, comprising a treatment of evolutionary perspectives on knowledge (Jürgen Renn).

→ p. 45

The gene regulatory network controlling the development and evolution of the seurchin embryo as an example of big-data-driven systems approaches in biology.

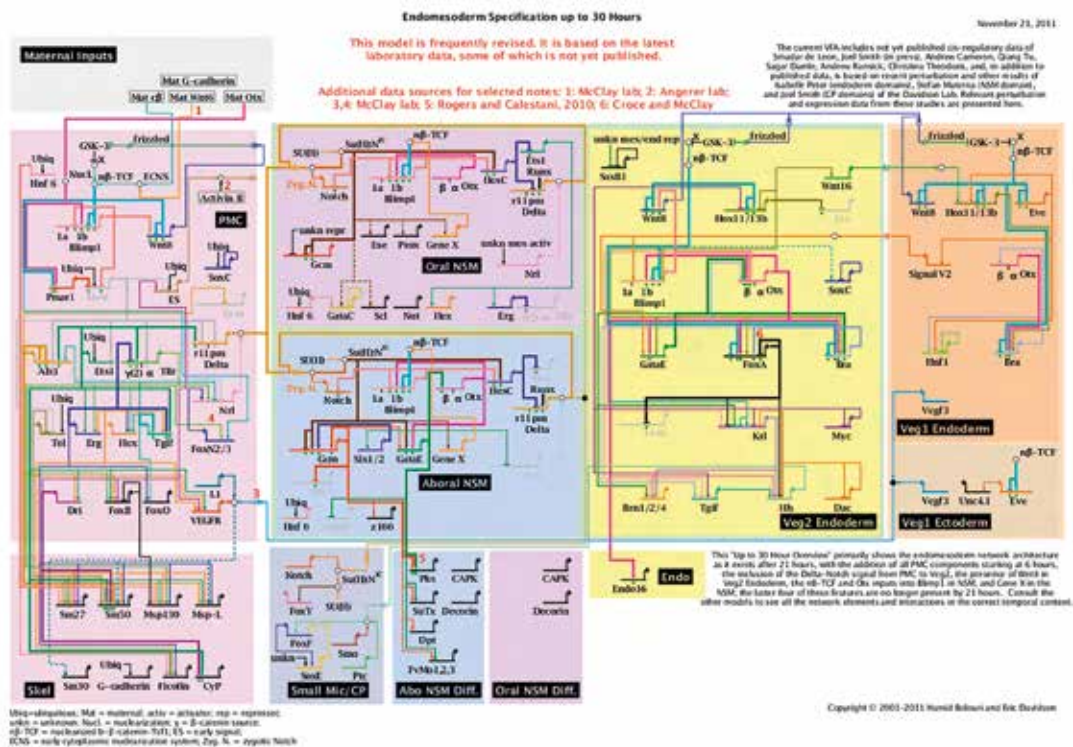

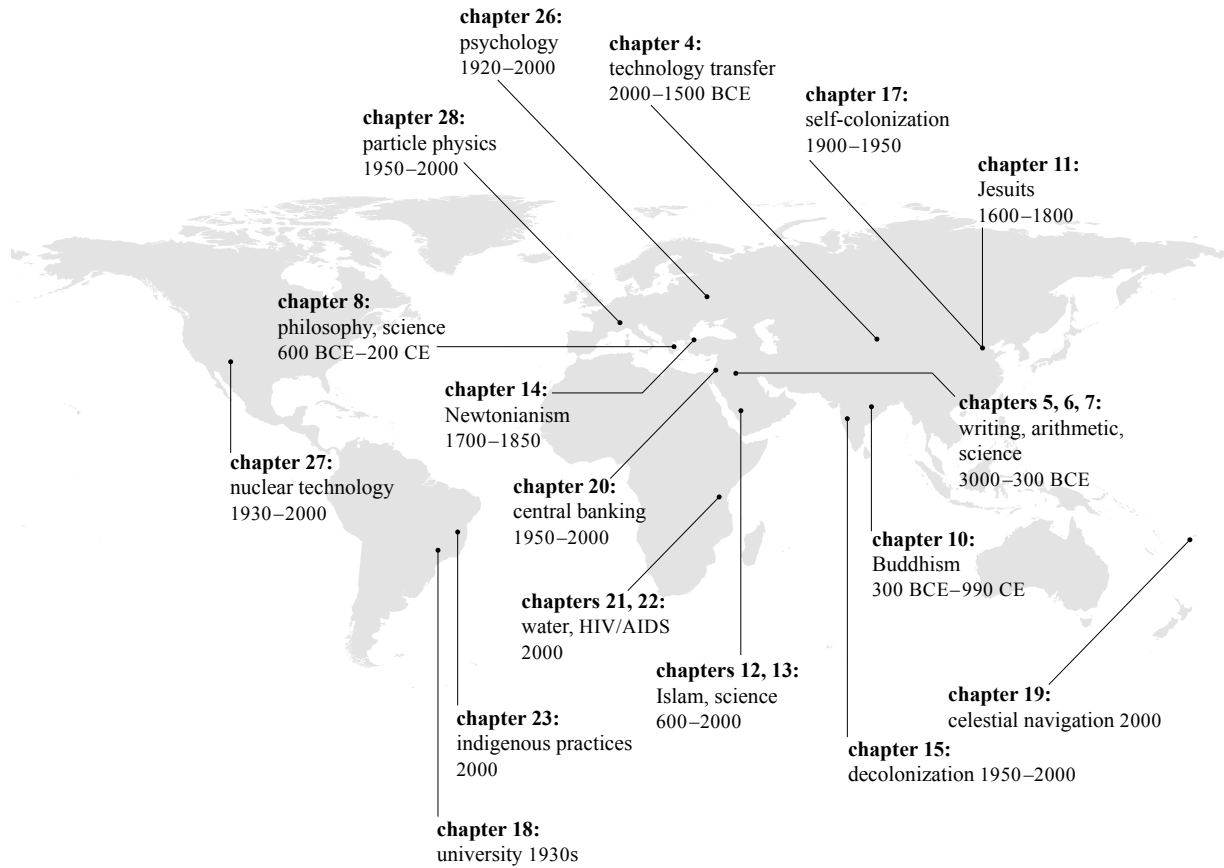

- chapter 1:** globalization in history
- chapter 2:** literature survey
- chapter 3:** origins of science
- chapter 9:** empires and religions
- chapter 16:** local knowledge
- chapter 24:** modern science
- chapter 25:** future university
- chapter 29:** molecular biology
- chapter 30:** chemistry and energy
- chapter 31:** climate
- chapter 32:** Epistemic Web

Chapter overview of *The Globalization of Knowledge in History*, 2011

Project

Globalization Processes of Knowledge

Epistemological Framework

Processes of cross-cultural transfer of knowledge have been studied in the framework of the project “The Globalization of Knowledge and Its Consequences.” Globalization is understood here as the global or potentially global diffusion of any means of social cohesion, be it economic, political, technical, cultural, or epistemic. In this general sense, it can be traced back to the beginnings of human history. Globalization processes typically involve several layers, such as the migration of populations, the spread of technologies, and the dissemination of languages, of religious ideas, or of political and economic structures. Recent discussions about globalization processes emphasize two apparently contradictory characteristics of such processes: homogenization and universalization, on the one hand, and their contribution to an ever more complex and uncontrollable world, on the other. The contrast between the tendency toward an ever “flatter” and an increasingly “fractal” world suggests that comprehensive globalization processes result from a superposition of these various layers, with knowledge playing a pivotal role in orchestrating the interaction of these layers, also by shaping the identity of the historical actors.

In studying the globalization of knowledge in history, an epistemological framework has been elaborated that enables the systematic analysis of historical processes of technology transfer, the spread of epistemic frameworks, the dynamic relation between local and global knowledge traditions, and the globalization of modern science (Peter Damerow, Malcolm Hyman, Jürgen Renn, Helge Wendt). It makes use of a classification of different forms of knowledge, of different forms of representation, as well as of transmission and transformation processes. The concept of the mental model is relevant here as well, for it allows the conceptualization of context-dependent reasoning mechanisms that are not mathematized or otherwise structured as a deductive system. This framework emerged from detailed case studies and has been published in a volume entitled *The Globalization of Knowledge in History*, edited by Jürgen Renn and including contributions by 32 scholars from different backgrounds. The approach developed in this book has since been applied to historical investigations covering an even wider array of cultures and historical periods.

Creating a Research Network

Studies of historical globalization processes of knowledge require multidisciplinary cooperative ventures, which are being pursued within a growing research network. The general framework was presented in a series of workshops, round table discussions, and lectures organized in cooperation with the Forum Transregionale Studien in 2012 (Jürgen Renn, Helge Wendt). In 2012 alone, around fifteen invited scholars actively participated in such workshops and collaborated with scholars of the Department. Specific foci of discussions were the role of multilingualism, *linguae francae* and translations, the role of individuals as actors of diffusion processes, as well as the role of systems of knowledge and of institutions in transfer processes. In line with the inherent requirements of the project and of the publication policy of the Max Planck Society, the four major events of 2012 were published in the form of a rich Internet website containing audio-video recordings of the talks and discussions, which are freely available (<https://public.mpiwg-berlin.mpg.de/global-transfer-of-knowledge/>).

Globalization of Technical and Theoretical Knowledge in Premodern Times

A current focus of the project, pursued in close cooperation with the TOPOI Cluster of Excellence, is the diffusion of practical and theoretical knowledge in the ancient world and its historical successors. Building on earlier research in this context, a junior research group has been established which is studying the role of the diffusion and diversification of technology and related technological knowledge for the emergence of scientific knowledge in a globalized ancient world (Jochen Büttner). The geographical scope includes the Mediterranean area, Persia, India, and China. A key example at the center of current research is the balance and its relation to other knowledge-intensive technologies.

The unequal-armed balance was presumably the most widespread and frequently used mechanical precision instrument in antiquity and late antiquity. The number of surviving artifacts is correspondingly large. It is the large number of extant and relatively well-documented artifacts, supplemented by textual and iconographic sources, that makes the unequal-armed balance a suitable model for a paradigmatic study of the origin, dynamics, and development of technological innovations, and of the cultural conditions and effects of these innovations in antiquity and late antiquity. The practical experience gained in the use of such balances not only served as a midwife at the birth of theoretical mechanics in the fourth century BCE, but also accompanied further technical development for more than 2000 years.



Equal-armed balance with additional counterpoise. Antikensammlung Berlin.

A case studied in parallel in the context of TOPOI is the development and spread of sundials and their relation to the history of astronomy. In both cases, historians of science and technology closely collaborate with archaeologists and philologists. By applying models and concepts developed in recent innovation studies to ancient

technology, this research endeavor aims at a clearer understanding of the processes by which technology developed in the ancient world. This research activity also intends to contribute to the formulation of a general theory of technical innovation that takes into account the effects of knowledge transmission across cultural breaks. Current work is accompanied by the development of innovative, computer-assisted instruments for mapping archaeological data. In particular, in cooperation with researchers from the German Archaeological Institute (DAI), a Web-based “Atlas of Innovations” is being created which allows such data to be represented in flexible forms supporting heuristic investigations into the diffusion of clusters of artifacts as markers of innovation processes. → p. 51



The globalization of knowledge involves sedimentation processes in which earlier phases of globalization leave vestiges that enable or constrain later phases of globalization. This is obviously the case for the spread of technologies, which is often a by-product of military, political, or commercial expansion, but which may well have less ephemeral effects than either, so that technologies remain in use even after empires or commercial connections have broken down. But such sedimentation effects are not limited to material culture. The spread of religions, for instance, may leave traces in the images of knowledge of societies, even after these religions have ceased to be a dominant force or are removed from their immediate range of concerns, as illustrated by the famous example of Protestant ethics and its much discussed long-term effects on the rise of capitalism and of science in northern Europe.

The ancient world and the societies that inherited part of its cultural patrimony witnessed the spread of another comprehensive, albeit secular system of knowledge, which also had long-term effects on the history of science: Aristotelianism. Aristotelianism eventually spread from Greece to the Hellenistic world, later across the Islamic empires, and, through colonialism, all over the world. In many places of the world, Aristotelianism played a significant role in creating and institutionalizing

The “Atlas of Innovations” is a digital tool for the representation and study of the emergence and development of key-technologies, such as wheel and wagon or glass, from the fourth millennium B. C. to the late Bronze Age. The example shows the distribution of early evidence for wagons in the context of settlements in the mid- fourth millennium, visualized with “Mappit,” a prototype for the Atlas of Innovations, developed at the MPIWG.

knowledge practices that sooner or later also affected the practice of science. Aristotelian knowledge in fact became a point of reference in the context of several traditions of scientific practice such as physics, biology, astronomy, and natural philosophy from antiquity to the end of the Renaissance.

Because the Aristotelian system of knowledge was continuously reshaped by many cross-cultural and cross-period transmission processes, it offers an appropriate historical domain for further developing the theoretical framework of the globalization project. What accounted for the virtually global spread of Aristotelianism? To what extent was Aristotelianism merely a fellow traveler of other diffusion processes, for instance, of Christianity, Islam, or colonialism, and to what extent did intrinsic features such as its systematic character and its self-reflexivity play a role in this global success?

These questions are at the center of a second major focus of the study of globalization processes in the premodern era, which is dedicated to the investigation of the “Aristotelization of the World” (Jürgen Renn, Matteo Valleriani, Helge Wendt, Sonja Brentjes, Matthias Schemmel, Pietro D. Omodeo, Stefan Paul Trzeciok). The aim of this investigation is to retrace the contexts and the structures of the knowledge that was eventually systematized in the Aristotelian doctrines when the first *corpus aristotelicus* was compiled by Andronicus of Rhodes in the first century BCE.

Table of contents of ‘Abd al-Rahman al-Khazini’s (d. after 1130) work on the *Balance of Wisdom*. From the Lawrence J. Schoenberg Collection, courtesy of the University of Pennsylvania Libraries.



Research in this area proceeds with a step-by-step examination of the different states of development, that is, period by period. For each period, a workshop is organized which involves the relevant experts and draws, in particular, on Berlin’s rich research tradition on Aristotelianism. The first workshop, held in 2012, was devoted to a reexamination of the Aristotelian doctrines and, specifically, to those characteristics which may have played a role in their transmission and appropriation in different cultural settings of the ancient world. The second workshop will be dedicated to the spread and transformation of Aristotelianism in late antiquity, in particular, in the context of medicine, Neoplatonic philosophy, early Christian theology, and the early Islamic world.

The third major research activity dedicated to globalization processes in the premodern era deals with the vehicles, networks, and mechanisms of knowledge transfer in the Mediterranean world of post-antiquity. It brings together historians of science and technology, philologists and historians of the Islamic world, and medieval historians (Jürgen Renn, Matteo Valleriani, Helge Wendt, Sonja Brentjes, David Nirenberg, Beatrice Gründler, Dimitri Gutas). Current work focuses in particular on the networks bridging religious, cultural, and political divides.

The research began with a workshop in 2011 devoted to the role of the Arabic language and the newly developed book culture for the transmission of technological and scientific knowledge. A second workshop was held in May 2011 that dealt with the transmission of prohibited and esoteric knowledge through space and time (Florentina Badalanova Geller). A third workshop was held in October 2012. The themes of this workshop ranged from the transfer of knowledge of mechanics,

alchemy, navigation, philosophy, map-making, bookmaking, religion, and medicine to a reflection on modern historiography of the Islamicate and the Christian world in cross-cultural contexts. Extended versions of all papers presented at the conference will be published in 2013.

In this context, scholars of the Institute have worked on four case studies: The first concerns the role of technological artifacts as a vehicle for the diffusion of mechanical knowledge from the fourth to the first century BCE in the Mediterranean region (Matteo Valleriani). The second concerns the emergence of a science of weights in an Islamicate context as a result of a hybridization of Greek scientific knowledge (Sonja Brentjes, Jürgen Renn). The third case study presents the constitutive role of a shared cultural space for the medieval tradition of portolan maps (Sonja Brentjes). The fourth case study analyzes the historiographical tools used since the eighteenth century for studying the global dimensions of the ancient world (Helge Wendt).

A further area of research in the context of the globalization project was knowledge transmitted in and through nomadic cultures. In cooperation with the Mongolian Academy the Sciences and the National University of Mongolia, together with several other Max Planck Institutes, an international workshop in 2011 was dedicated to this theme with the aim of setting up a research group in Mongolia (Tuvdendorj Galbaatar, Jürgen Renn, Gerhard Wolf, Simone Rieger, Urs Schoepflin).



Frontispiece of the *Margarita philosophica nova* by Gregor Reisch, 1508. A three-faced angel of natural philosophy, logic and moral philosophy resides over the liberal arts: A depiction of the arts faculty of a university in early modern Europe.

The Globalization of Science in the Modern World

The globalization of knowledge today has reached a new stage: new potentials for the globalization of knowledge have emerged, such as the global system of science and the World Wide Web. The migration of scientific knowledge is no longer characterized by the trajectories of individuals, but rather by global social patterns. Scientific knowledge is involved in global economic processes; it is embedded in global infrastructures and regulatory regimes and is part of global cultural products. Research on the globalization of knowledge in the modern world aims at tracing these developments by analyzing, in the context of workshops, case studies, and cooperative ventures, both the intrinsic and the extrinsic dynamics of knowledge development.

One workshop, organized in cooperation with the MPI for Social Anthropology, has been dedicated to the emergence of anthropology and ethnology in the eighteenth and nineteenth centuries as a result of globalization processes with respect to knowl-

edge (Han Vermeulen). Particular attention was devoted to the paths of communication among scientific communities at the European core and the European periphery. The results of the workshop will be published as a working-group volume.

Earlier work on the diffusion and translation of economic policy during the twentieth century from contexts of the global North to the global South (Arie Krampf) was continued. An edited volume on the history of physics in Cuba is in preparation (Angelo Baracca, Jürgen Renn, Helge Wendt).

Research on the history of resource transformations has emerged as a new focus of the project (Helge Wendt, Jürgen Renn). The challenges of the current energy system are addressed in the contributions to a volume jointly edited by Jürgen Renn, Robert Schlögl, and Hans-Peter Zenner: *Herausforderung Energie*. One of the conclusions suggested by these studies is that research on future energy systems should not prematurely focus on one single direction; rather, it is essential to consider various generalized energy supply scenarios that take into account local social, environmental, and cultural conditions. Discussions of the current situation also suggested the need for a global history of the transformations of basic resources and of the knowledge to deal with them. In cooperation with the Freie Universität, a new junior research group dedicated to this theme is currently being established.

A related research focus is the history of the Anthropocene (Christoph Rosol, Helge Wendt, Jürgen Renn, José Pacheco). On behalf of the Humanities Section of the Max Planck Society, Jürgen Renn has coordinated the participation of Max Planck researchers in a collaborative venture of the Haus der Kulturen der Welt (Berlin), the Deutsches Museum (Munich), the Rachel Carson Center (Munich), and the Max Planck Society. The Nobel Laureate Paul Crutzen has used the concept of Anthropocene to describe the current geological epoch characterized by the large-scale effects of human interventions in the planetary system. One aim of this cooperation is to stimulate interdisciplinary research on this concept and on its implications for the understanding of human history, including the globalization of knowledge. Another

aim is to enhance public awareness of such a global perspective, encouraging a more reflective approach to science and technology through cultural and artistic events and through exhibitions. In preparation for the main working period (2013/14), two interdisciplinary workshops have been held to develop the research agenda of the project.

Map of the Internet by the Opte Project (www.opte.org).



Project

Concepts, Methods, and Implementations of Historical Epistemology

In addition to the main research lines focusing on the longitudinal and the transversal histories of knowledge, respectively, concepts and methods of historical epistemology, as well as new forms of the dissemination of research results, are being developed and explored.

One research strand is dedicated to the genesis and development of the relation between the history and philosophy of science in the nineteenth and twentieth centuries (Olaf Engler, Jürgen Renn). In a group of studies, source materials on the history of this relationship are analyzed. Of special interest within the framework of the project is the period of scientific philosophy, extending approximately from 1850 to 1930. This period is characterized by the fruitful interaction of the revolutionary transformations of physics with philosophical perspectives on science, but also with developments in experimental psychology and biology. In the course of this development, radically different perspectives on science emerged, amounting to what one might call “a split of scientific rationality” which shapes the debate to this day. In this context, the project specifically investigates the conflicts between the history, philosophy, and sociology of science as a result of this split of rationality, but also their integration into the concepts and methods of a historical epistemology.

Under the heading “Historical Epistemology in Action,” novel forms of dissemination combining scholarly communication with public outreach have been adopted to investigate the potential of history of science as a mediator between science and society, also in the service of the Max Planck Society as a whole. In close cooperation with the library and the IT group of the Institute, advanced tools for an historical epistemology have been developed and innovative ways of creating access to the empirical basis and the research results of the history of science have been explored. Research was furthermore made public in the framework of exhibitions, lectures, and school and public relations activities, as well as by developing workflows for open access publications (Peter Damerow, Jochen Büttner, Lindy Divarci, Simone Rieger, Matthias Schemmel) and concepts for new curricula in undergraduate education (Yehuda Elkana, Christian Joas, Christoph Lehner).

Theories of Rationality in the History of Science



The founder and leading figure of the Vienna Circle, the physicist and philosopher Moritz Schlick (1882–1936) in 1934. © George Moritz H. van de Velde-Schlick

In 2006, a close cooperation was established between Department I, the Moritz Schlick Research Institute, and the Center for Logic, History and Philosophy of Science at the University of Rostock. Different studies investigate the relation between the so-called scientific philosophy and the revolutionary developments in the natural sciences during the period from 1850 to 1930, especially in modern physics but also in experimental psychology and biology. Scientific philosophy is represented here by such scientist-philosophers as Hermann von Helmholtz, Ernst Mach, Pierre Duhem, Henri Poincaré, and, most prominently, Moritz Schlick and Hans Reichenbach.

Toward the beginning of the twentieth century, different theories of rationality emerged as a result of the reflection on science in the making. Investigations focus on the understanding of the genesis and development of these various theories of rationality as embedded within their specific historical contexts. This undertaking includes the attempt to explore the tensions between the different approaches to science, such as the philosophy, history, and sociology of science, but more recently also their integration within the framework of the concepts and methods of a historical epistemology (Olaf Engler, Jürgen Renn).

One core area of the project is the survey of source materials on the history of the relation between the history and philosophy of science in the twentieth century. In this context, the final two volumes of the *Hans Reichenbach Gesammelte Schriften* are being prepared for publication with Springer Wien/New York. These volumes contain papers from Reichenbach's entire productive period, supplemented by detailed introductions and historico-critical comments (Olaf Engler, Dieter Hoffmann).

Alongside these volumes, a commented edition of Reichenbach's extensive correspondence is being prepared for publication as part of the Edition Open Access (Andreas Kamlah). Similarly, as part of the *Moritz Schlick Gesamtausgabe*, substantive research has been invested in studying and editing Schlick's writings on relativity theory and quantum physics (Olaf Engler). Ongoing activities include the publication of selected parts of the literary estate of Moritz Schlick and Hans Reichenbach through the ECHO platform.

Within the scope of this project, a new edition of *Die Mechanik in ihrer Entwicklung. Historisch-kritisch dargestellt* was also published (Giora Hon, Gereon Wolters). Three further volumes, Mach's *Optics*, as well as collections of writings on physics and on history and philosophy of science, are currently in preparation (Dieter Hoffmann, Jürgen Renn). Looking ahead, an agreement for further cooperation with the Institute Vienna Circle (Friedrich Stadler) has been secured.

The changes experienced in this period in the framework of physics went along with fundamental changes in other disciplines such as psychology. A dissertation project is dedicated to the history of experimental psychology in Germany, from the establishment of the first laboratory (1879) to the Nazi *Gleichschaltung* (1930s) (Anna Perlina). It shows, in particular, how Kurt Lewin developed a holistic research agenda that integrated elements from diverse disciplines, such as philosophy, physiology, and physics, in order to achieve his experimental program of a "psychology of action and emotion."

Reorganizing Physical Knowledge through Philosophical Reflection

Specific studies have focused on the fruitful interaction between the philosophy of science and the development of modern physics at the beginning of the twentieth century, with a particular focus on the discussions between Albert Einstein and Moritz Schlick on the physical interpretation of the emerging theory of general relativity (Olaf Engler, Jürgen Renn).

A crucial aspect of the history of general relativity was Einstein's formulation and eventual rejection of the famous hole argument. While the hole argument initially seemed to suggest that generally covariant theories of gravitation are impossible, its later rejection opened up new insights into the nature of space and time, and in particular their dependence on dynamical fields. In contrast to the accepted view, it could be shown that Moritz Schlick's principle of spatio-temporal coincidences played the decisive role in Einstein's overcoming of the hole argument. This principle is first documented in a text from Moritz Schlick's estate from 1910.

In the context of general relativity, Schlick's principle implies that only point coincidences constitute measurable entities in physics. Einstein's acceptance of this principle was closely related to his reading of Hume and the formative role of Hume's epistemology for the formulation of special relativity. On an epistemological level, it furthermore complemented, from Einstein's perspective, the role that Mach's principle long played as an ontological underpinning of his new theory of gravitation, giving primacy to material events over the structures of space and time. The coincidence principle thus unfolded a vast integrative potential linking different dimensions of knowledge and establishing criteria for the aspects of physical reality reflected by the new theory. Its further implications are also pursued in the context of the ongoing research on the history of quantum gravity. → p. 41

The Split of Rationality and the History of the History of Science

Since the beginning of the twentieth century, reflection on science tended to be separated into four branches: a philosophical-normative branch, a historical-descriptive branch, a political-pragmatic branch, and the reflection taking place within science itself. The result was a split of rationality, largely separating science from a reflection referring to its contents as well as to its contexts and societal conditions. Whereas philosophy of science was dominated by a focus on the analysis of language and methodology, taking them as embodiments of an ahistorical scientific rationality, history of science paid attention to ideas, events, and their more or less contingent circumstances, without critically examining the underlying normative rationality, let alone substituting it with its own form of historical rationality.

The history of this split is being investigated in the context of a broader set of studies dedicated to the history of the history of science (Olaf Engler, Kostas Gavroglu, Jürgen Renn). Related research supported by the Institute was concerned with a post-Kuhnian approach to the history and philosophy of science, and is now in the process of being incorporated into a larger book project, tentatively entitled "*Scientific Philosophy and the Dynamics of Reason*" (Michael Friedman).

In this context and following up on earlier research reflecting on the history of the discipline (see, for example, *Positioning the History of Science*, 2007), a major international workshop entitled "Towards a History of the History of Science: 50 Years since



Participants of the 8th International Congress of Philosophy in Prague (September 2–7, 1934).

Front row: Gaston Bachelard (7th from left), Hans Driesch (8th from left), and Moritz Schlick (9th from left).

Back row: Hans Reichenbach (2nd from right) and Rudolf Carnap (8th from right).
© George Moritz H. van de Velde Schlick.

Structure” was held by Department I in October 2012. Commemorating the publication of Thomas Kuhn’s *The Structure of Scientific Revolutions* in 1962, the workshop invited participants to present approaches to the history of the history of science as a field of research and as a discipline over the last fifty years.

Organized by Alexander Blum, Kostas Gavroglu, Christian Joas, and Jürgen Renn, the workshop brought together many of the leading figures of a plurality of strands in the history of science, as well as younger scholars. It was intended to be the first in a planned series of workshops of different formats aimed at studying how the history of science has evolved as a field of research over the last fifty years, both intellectually and institutionally. The results of the workshop will be published in an edited volume, which currently is in preparation for publication in Edition Open Access. The workshop’s presentations and round-table discussions are available online: <http://www.mpiwg-berlin.mpg.de/workshops/en/History-of-History-of-Science.html>.

Historical Epistemology in Action

Science and scholarship in the humanities evolve as parts of a comprehensive system of knowledge. External representations of knowledge such as language, writing, and new media such as the Internet are closely intertwined with this evolution. The emergence of digital humanities is therefore expected to profoundly impact the structure of scholarly work as well as society at large.

In compliance with this insight, the Department explores new Web-based forms of knowledge dissemination in order to probe the potential of innovative information technologies for opening up new horizons for the humanities and for redefining their place in society. The Department furthermore investigates the capacity of the history of science to act as a mediator between science and society.

New media and the Internet have facilitated new modes of cooperation and new forms of publishing scholarly data and results. Against this setting, the idea of an Epistemic Web has emerged. Ideally, the Epistemic Web of the future will promote the creation of dynamic representations of knowledge, integrate research and dissemination, accommodate recursive processes of knowledge formation, and assimilate conceptual models and data.

In the period covered by this report, Department I has continued to push forward the realization of some of the key concepts of the Epistemic Web, in particular by further developing the research-driven infrastructure that is fundamental to all Internet-based working environments and presentations of the Department's research projects. Research results are integrated in these virtual research environments and have also been presented as online publications or in traditional formats. In addition,

An anonymous manuscript containing an elementary treatise on fortification (MS. 197), made freely available within the ECHO framework by the Biblioteca Oliveriana, Pesaro.



digitized cultural heritage has been made publicly accessible on the Internet in a sustainable form, complemented by tools for a Web-based scholarly analysis of these sources.

Source Repositories, Virtual Research Environments, and New Forms of Dissemination

Digital sources are typically distributed over separate collections; work with such sources relies on new forms of scientific communication and may result in new, alternative forms of publication. Making use of these sources thus calls for novel research environments that can provide adequate support for this new form of scholarly work. Department I is highly engaged in providing scholars with such working environments and in promoting their use. If well designed, such working environments and tools not only facilitate research, but in fact have the capacity to initiate new research questions and approaches.

In order to serve the specific needs of scholars working with sources in the humanities, a number of services and tools have been developed which, as a complementary service, are to become part of the generic infrastructure of the Max Planck Digital Library (MPDL). These include a Web-based workflow for generating structured texts in XML-format, starting from printed sources; an integrated environment for storing, querying, and displaying such texts, enhanced by supplementary information and thus enabling semantic access to their content; a universal annotation system for digitized sources; MapPIT (Map Places In Time), a tool for generating, editing, and representing geo-referenced data in a simple manner; and VSPACES, a tool for the creation of the structured representation of knowledge according to a topological paradigm (Andrey Bukhman, Jochen Büttner, Robert Casties, Julia Damerow, Falk-Juri Knauff, Wolfgang Schmidle, Simone Rieger, Klaus Thoden, Jorge Patricio Urzúa Contreras, Josef Willenborg, Dirk Wintergrün)

Common to all of these tools and services is the aim to lessen the amount of purely technical expertise required in realizing the individual steps of the scholarly workflow. As part of a future working environment, these tools and services will not least contribute to dissolving the barrier which still prevails in the humanities between the editing of sources, their interpretation, and the publication of these interpretations. The complete scholarly workflow will thus be in the hands of the scholars themselves.

Within the report period, the open access infrastructure “ECHO – Cultural Heritage Online” <echo.mpiwg-berlin.mpg.de> has been expanded and is now established as the basic working environment for all of the Department’s research projects and for those of many of its collaborative partners. ECHO’s open repository (built up with substantial support from the Institute’s library) includes more than 206,600 catalogued documents comprising more than 880,000 high-resolution images of historical and cultural source documents and artifacts. These documents have been made available by more than 170 institutions from 24 countries worldwide. Within the last three years, about 39,000 new high-resolution images have been made available. Among the newly incorporated archival material are manuscripts of the Guidobaldo del Monte Archives from Pesaro, the Federico Commandino Manuscript Collection from Urbino, and the Manuscript Collection of the Centro Internazionale di Studi

→ p. 203



Rosminiani in Stresa, as well as parts of the collections of the “Islamic Scientific Manuscripts Initiative” (ISMI), all of which are directly relevant for the ongoing research projects of the Department.

In line with the effort to collect and publish cultural heritage sources pertinent to the Department’s projects, cuneiform artifacts preserved in fourteen different collections all over Europe and the Middle East have been digitized and made openly available as part of the “Cuneiform Digital Library Initiative” (CDLI). In addition, published and unpublished line art of cuneiform texts have been scanned and prepared for release (Peter Damerow, Christina Tsouparopoulou, Luděk Vacín). In the case of the Hilprecht collection of cuneiform tablets preserved at the University of Jena, researchers and curators have decided to produce 3D scans, as these have proven most beneficial for decipherment. The required 3D-scanning technology has been implemented and extensively tested. The development of new formats for the presentation of new tools for the analysis of the rich raw data is underway (Peter Damerow, Manfred Krebernik, Jörg Kantel, Matthias Schemmel).

Working with and publishing disordered and fragmentary historical sources, in particular manuscripts, has been a recurrent challenge in many of the Department’s research projects. In order to explore the possibilities offered by digital technology in addressing this challenge, an online edition of some eight thousand manuscript pages by Thomas Harriot has been created, in which the content of the individual folios is classified and mapped thematically, and presented together with transcripts, translations, and commentaries (Jacqueline Stedall, Matthias Schemmel, Klaus Thoden, Jochen Büttner, Dirk Wintergrün, Simone Rieger, Urs Schoepflin): http://echo.mpiwg-berlin.mpg.de/content/scientific_revolution/harriot.

The strong integration of sources and their interpretations is one of the key ideas of the Epistemic Web. In accordance with this idea, “The Years of the Cupola,” the digital edition of the surviving administrative documentation in the historic archive of the Opera of Santa Maria del Fiore for the period 1417–1436: http://duomo.mpiwg-berlin.mpg.de/home_eng.HTML, has been complemented by a *Studies* section. In the this section, interpretative texts concerning the material in the archive are presented. The *Studies* section is expected to grow into a comprehensive repository for all kinds of scholarly studies of this important construction site and the world of its contexts (Jochen Büttner, Margaret Haines).

Many of its scientific cooperation partners have adopted methods and tools developed by Department I. The Mongolian Academy of Science, for instance, which has

A brick stamp of the third Ur III king Amar-Suen (ca. 2046–2038 BC), from the collection of the Bibliothèque Nationale et Universitaire de Strasbourg (CDLI, 2012).

recently founded a new research group investigating the globalization and transmission of knowledge between Europe and Asia along the Silk Road through Mongolia, has modeled its own virtual research environment on the example of ECHO. To foster common research activities, the Institute (Simone Rieger, Urs Schoepflin) offered expert advice for the creation of a Competence Center for Digitization of Mongolian Cultural Heritage in Ulaanbaatar, including the training and support necessary for making Mongolian cultural heritage publicly available.



Agvanlodoi venerable Mongolian sakyā scholar, landscape handbook, seventeenth century.

In cooperation with the Humboldt University of Berlin, the research and documentation environment “The Musawwarat Graffiti Archive – African Cultural Heritage & the Globalization of Knowledge”: <http://musawwaratgraffiti.mpiwg-berlin.mpg.de/project/publications.html>, funded by the Golden Web Foundation, has been launched (Cornelia Kleinitz, Simone Rieger, Robert Casties, Urs Schoepflin). Over a period of more than two thousand years, thousands of graffiti have been incised into the walls of the Great Enclosure of Musawwarat es Sufra in Sudan. For their documentation, the ECHO model has been adopted and complemented by new facilities to ease the open access presentation of this intricate visual data.

Open Access Publications

Databases, digitized historical sources, computer-based tools for analysis, and the network of links integrating sources with scholarly interpretations play an important role in history of science and are increasingly becoming an integral part of digital humanities. Yet current publications, both traditional and digital, continue to make scant use of this potential. In a joint initiative with two other Max Planck Institutes, the Fritz Haber Institute of the Max Planck Society and the MPI for Gravitational Physics (Albert Einstein Institute), the Department has therefore launched a new open-access publishing venture, the Max Planck Research Library for the History and Development of Knowledge (Peter Damerow, Lindy Divarci, Jörg Kantel, Jürgen Renn, Simone Rieger, Matthias Schemmel, Kai Surendorf).

Titles from Edition Open Access:
www.edition-open-access.de.



As part of a wider framework, Edition Open Access aims to establish open access publication, not so much as a new economic model (i. e., drastically reduced costs), but as the backbone for a new knowledge infrastructure in compliance with the idea of an Epistemic Web (www.edition-open-access.de). This infrastructure is also in line with the Berlin Declaration on Open Access to Knowledge in the Sciences and Humanities, which was launched by the Max Planck Society in 2003 and is supported by more than four hundred signatory institutions worldwide.

The Max Planck Research Library combines the advantages of printed books with the potential of the electronic medium, for instance, to represent, search, and annotate sources in high-quality reproductions. The vision is to create a complete workflow — from digital libraries to scholarly publications — in the form of a “Digital Scrapbook” that will support every step of the research and dissemination process. For Edition Open Access, a workflow has been established that can produce from a single source text a freely downloadable PDF file, an e-book, and a print-on-demand volume, available via the book market. The rich hypertext structure of the books is used to create links to online historical documents, dictionaries, and multimedia material, as well as a commentary function. The Max Planck Research Library comprises a number of subseries, among them *Sources*, *Studies*, *Proceedings*, “with *Textbooks*, and *Essays* planned for 2013. The entire infrastructure was set up within a period of two years; to date seven volumes have been published and several more are in preparation.

→ p. 203

The Digital Scrapbook is a new document format for the Web, serving as an interactive and collaborative virtual workspace for the humanities. It integrates excerpts from digital libraries with tools for their cooperative analysis and commentary, and supports workflows for the cumulative report of intermediate results to the final publication.

A New Paradigm: The “Digital Scrapbook”

Electronic tools as they are currently available support almost the entire scholarly workflow, from the identification of historical sources to the publication of their interpretation. This workflow, however, is presently characterized by numerous media discontinuity at which potentially relevant information, for instance, about links between different sources or between sources and secondary literature, is lost or not adequately presented. For example, images or transcriptions of sources, bibliographic references, comments and annotations produced in the context of ongoing research, cross-references to other relevant materials, dictionary entries, geographic information, search histories are often not preserved and have to be reproduced in different stages of work. In order to address this problem, the vision of a “digital scrapbook” has been jointly developed with the Max Planck Digital Library (Frank Sander, Jürgen Renn, Jochen Büttner, Robert Casties, Dirk Wintergrün, Jörg Kantel).

The digital scrapbook supports the full spectrum of source-based scholarly work, from the first annotation to the final publication, in a unified format supported by the same tools. The scrapbook manifests itself in the combination of a particular document type (the scrapbook document) with modular tools. Through shared methods of access, collection, annotation, referencing, and visualization of

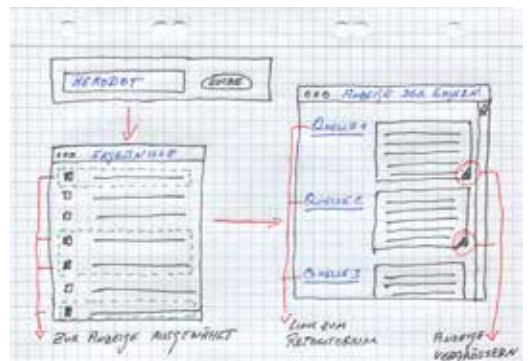

sources, these tools can generate, process, and store scrapbook documents. In the scrapbook paradigm, the pathway from a digital excerpt, via its annotation and evaluation, to the final interpretation is a continuous process without media discontinuity. From the beginning, digital sources have formed part of an evolving network and remain accessible on the Web. Because a given source is linked to an interpretation, a network of connections and references emerges. The scrapbook paradigm thus comprises the classical approach of the humanities to source analysis, from annotation to publication, but goes beyond this by including reversibility and interactivity.

Outreach Activities

During the report period, members of Department I have made use of a broad spectrum of formats to communicate the history of science not only to experts, but also to the interested public, for example by means of smaller and larger exhibition projects. In 2010, a consortium of major academic and cultural institutions, among them the Max Planck Society, organized a science year focusing on the last 300 years of the history of science in Berlin. The highlight was the exhibition *Weltwissen*, co-organized by the Staatsbibliothek zu Berlin, the Berlin-Brandenburg Academy of Sciences and Humanities, the Humboldt University of Berlin, the Charité Berlin, and the Department. The exhibition was presented for three months at the Martin-Gropius-Bau, when more than 75,000 visitors were able to view over 1,500 objects. Department I participated in the planning of the exhibition and curated several sections, in particular sections on the history of the Kaiser Wilhelm Society, on the history of the decipherment of cuneiform writing, and on open access policy (Jürgen Renn, Peter Damerow, Manfred Krebernik, Simone Rieger).

Installation by Mark Dion in the exhibition *Weltwissen*, 2010. Photo: Roman März, 2010.



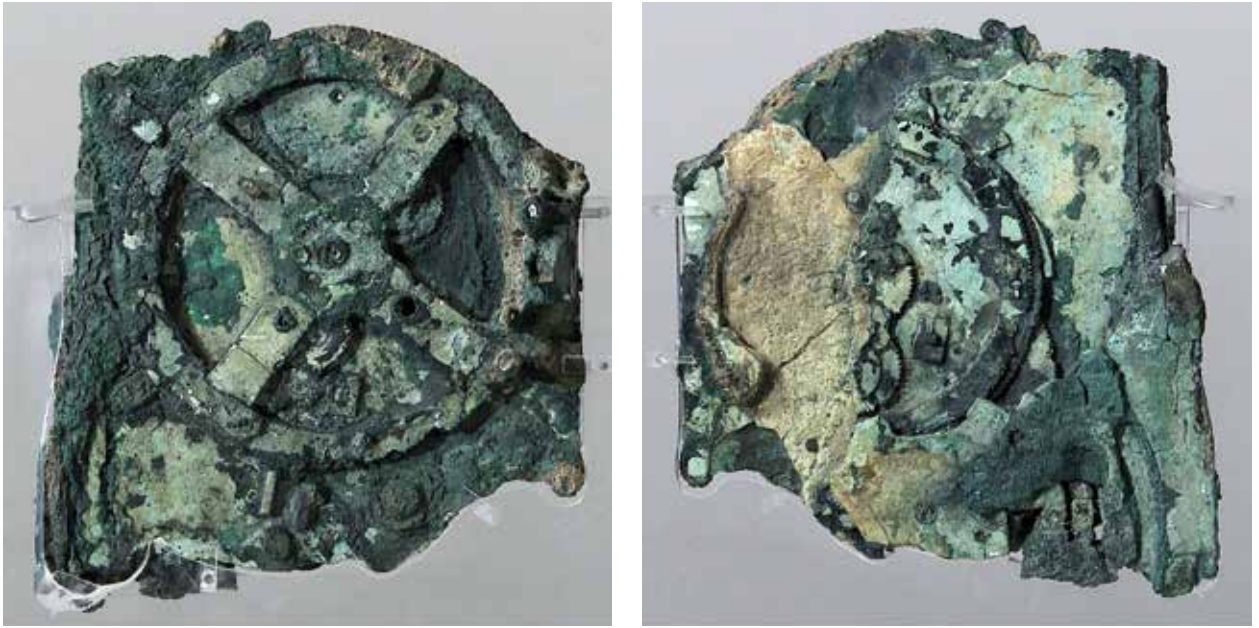

A much smaller exhibition was shown between September 2011 and January 2012 on the premises of the Institute. It displayed and explained the Antikythera mechanism and gave insights into pertinent research (<http://intern.mpiwg-berlin.mpg.de/antikythera/>) (Matteo Valleriani, Marius Schneider, George Vlahakis).

The Antikythera Mechanism,” an archaeological object, dated ca. 80–60 BCE, containing gears, dials, and inscriptions. From the National Archaeological Museum in Athens.

The Department also participated in the planning of the much larger exhibition *Jenseits des Horizonts*. This project was dedicated to ancient science and knowledge and introduced the research of the Excellence Cluster TOPOI (Jochen Büttner, Jürgen Renn). It was presented in 2012 at the Pergamon Museum and received more than 100, 000 visitors. The Department furthermore collaborated with the Kunstbibliothek in Berlin on an exhibition entitled *On the Plurality of Worlds: The Arts of Enlightenment* (Jürgen Renn, Matthias Schemmel).

Another large exhibition project is currently in preparation, together with the Museo Galileo in Florence (Paolo Galluzzi, Jürgen Renn). Dedicated to Archimedes and his impact on European culture, it will be shown in 2013 in the Musei Capitolini in Rome, and later also in Berlin.

The Department also presented several of its own research projects, such as projects on the long-term history of mechanics and on the globalization of knowledge, as well as its open access activities in science exhibitions organized by the Max Planck Society, in particular those in the “Science Tunnel” and at the “Max Planck Science Gallery” (Helge Wendt, Jochen Büttner, Matteo Valleriani, Simone Rieger).

Together with the Comenius-Garten Berlin-Neukölln, the Department has also developed new ways of opening discussions on the history of science to a broader public, and in particular to children. In 2010, both institutions used the occasion of the exhibition *Weltwissen* to hold weekly open science workshops for children. These workshops were structured in analogy to the “Werkstatt des Wissens,” an established format at the Comenius-Garten, where children, accompanied by scholars from the Department, engage in research activities. As part of the ongoing cooperation with the Comenius-Garten, several workshops bridging the arts, science, and the history



TOPOI exhibition *Jenseits des Horizonts*. Model of a Roman celestial globe with copy of a fragment and (in the background) a model of the mechanism of Antikythera.

of science have also been organized (Henning Vierck, Tzveta Sofronieva, Carmen Hammer). Joint projects with the Department have been on display since March 2012 at the Comenius-Garten in the context of a small exhibition open to a broader public.

Children researching at the “Werkstatt des Wissens” in the Comenius-Garten Berlin-Neukölln, 2012. Photo: Erik-Jan Ouwerkerk, 2012

In 2011, Tzveta Sofronieva was invited to the Institute as Writer in Residence. Inspired by the activities of the Comenius-Garten, she also organized poetry workshops for primary schools, supported by the Robert Bosch Stiftung.

Further cooperation with schools took place in the context of the centenary of the Kaiser Wilhelm Society in 2011, in the form of joint workshops with high-school students. These workshops were dedicated to the history of the society, but also to the

history of mechanics, of astronomy, and of quantum physics. Discussions on current research projects at the Department have even resulted in student projects and a general discussion of how to implement the history of science as a school subject in Berlin high schools (Simone Rieger, Christian Joas, Alexander Blum, Dieter Hoffmann, Horst Kant).



Knowledge in Context: From Local Universalism to Global Contextualism

In 2011, a collaborative project aimed at innovative undergraduate curricula was initiated by Yehuda Elkana, and supported by Peter-André Alt, president of the Freie Universität Berlin, and the Department (Jürgen Renn). The project, entitled “Knowledge in Context: From Local Universalism to Global Contextualism,” was supported by the *Einstein Stiftung Berlin* and the *Mercator Foundation*. Its goal is to place the paradigm of concerned citizens in a democratic society at the center of undergraduate education. Questions of societal relevance rarely fall into disciplinary categories, yet interdisciplinary approaches are often absent in undergraduate education. The project therefore aims, with the support of the Institute’s expertise in historical epistemology, at developing novel forms of interdisciplinary courses, designed around important and complex “real life” issues. A first outcome of the project is a programmatic book (Yehuda Elkana, Hannes Klöpffer).

The project has two primary goals: First, concrete course scenarios are being developed which bridge interdisciplinary gaps in university education by focusing on questions that are deliberately chosen to transcend disciplinary confines. Two such scenarios have become operational in the winter semester 2012/13: environmental law (Sigrid Boysen, Freie Universität) and the history and philosophy of physics as part of physics teaching (Alexander S. Blum, Christoph Lehner). Second, and in parallel, networks are being established both of further collaborators within the Freie Universität and of additional partner institutions worldwide that are committed to developing and establishing similar integrated undergraduate curricula (Manfred Laubichler).

Sadly, the untimely death of the project’s Principal Investigator, Yehuda Elkana, has proven a tremendous loss and necessitated a reshaping of the project’s organizational setup.



Yehuda Elkana (1934–2012) advised and promoted the Institute from its foundation. He initiated and developed, as a guest scholar of Department I, a project on interdisciplinary undergraduate curricula involving historical and comparative epistemology.

Rohini Devasher (New Delhi, India)
Parts Unknown: Making the Familiar Strange

"Parts Unknown" is the result of a four-month residency in Department II from March to June 2012. Rohini Devasher's artistic practice over the past few years has been rooted in science, manifesting itself through content, concept, media, and technology. Her work has taken many directions, driven sometimes by an exploration of the self-organization of patterns, morphology, and morphological relationships, and more recently by an interest in processes of emergence and emergent behavior. Her work explores the interface between art practice through the lens of metaphor, focusing in particular on drawing and astronomy.



Department II

Ideals and Practices of Rationality

Director: *Lorraine Daston*

Introduction: Histories of the Self-Evident

The research projects of Department II (established in 1995) chart the history of epistemic categories and practices that have become so fundamental to modern science and culture that they seem self-evident. Examples described in this report include “data” and “information” (“The Sciences of the Archive”), “gender” (“Gender Studies of Science”), and modern classifications of knowledge (“Between the Natural and the Human Sciences”). Because the hidden histories of these taken-for-granted objects become visible only when contexts vary, most projects have a comparative dimension, spanning many centuries, several cultures, or both (“Science in Circulation”).

Research projects in Department II embrace one or more Working Groups, which aim toward a collective publication, as well as the projects of individual scholars writing doctoral dissertations, monographs, book chapters, and journal articles on topics related to the main theme. A bibliography of publications listed by researcher’s name may be found at the end of this volume. Past Working Group publications of Department II include *The Moral Authority of Nature* (2004), *Things That Talk: Object Lessons from Art and Science* (2004), and *Natural Laws and Laws of Nature in Early Modern Europe* (2008). *Histories of Scientific Observation* appeared in 2011. In addition to the numerous meetings of the Working Groups, conferences are organized each year in conjunction with departmental research projects. The organization of this report follows that of the Department’s major research projects. Working Groups, conferences, and individual projects are listed under each project rubric, as is information on institutional cooperation partners.

At any given time, there are approximately 25 resident scholars in Department II: pre- and postdoctoral fellows, visiting scholars, and research scholars. Their backgrounds are international and multidisciplinary; their stays are funded by both MPIWG stipends and external sources (see individual entries for details). All resident scholars gather at the bimonthly departmental colloquium to discuss precirculated works in progress, starting with the all-day departmental workshop in September.

Approximately three quarters of the colloquium presentations are given by resident scholars of the department; the remaining quarter is given by invited guest speak-

ers — both from within and outside the Institute — selected for the relevance of their work to departmental research projects. Informal seminars and reading groups also offer venues for discussion of shared research interests by resident scholars, often joined by colleagues from other departments and research groups.

The reporting period 2010–2012 brought several welcome additions to Department II. Three new, externally financed, independent research groups, led by Suparna Choudhury (“Constructions of the Brain: The Emergence of the Neurological Adolescent”), Elaine Leong (“Reading and Writing Nature in Early Modern Europe”), and Viktoria Tkaczyk (“The Making of Acoustics in 16th- to 19th-Century Europe”), widened the scope of the Department’s research. Thanks to a major grant to McGill University, the generosity of the Staatsbibliothek Berlin, and the support of the MPIWG Library and IT Group, it has been possible to digitalize and make available to scholars rare medieval astronomical manuscripts (“Islamic Scientific Manuscripts Initiative”). Finally, a new predoctoral fellowship program, “Writing-Up” fellowships, advertised internationally to provide outstanding doctoral candidates with six months of support for the final stages of their dissertations, has enlivened the Department with new faces and new ideas.

Members of Department II,
fall 2010



Project

The Sciences of the Archive

DURATION 2010–2015

MPIWG ORGANIZERS *Elena Aronova, Etienne Benson, Lorraine Daston, Christine von Oertzen, David Sepkoski, Fernando Vidal* (ICREA, Universitat Autònoma de Barcelona, Spain)

COOPERATION PARTNERS Laboratoire SPHERE (CNRS, France), University of California at Los Angeles (USA), University of Wisconsin at Madison (USA), University of Lisbon (Portugal)

“Data” (literally, “the givens”) is perhaps the most taken-for-granted word in all of the sciences: short and unpretentious, it expresses the simplest and apparently most straightforward elements of empirical research. Whether inscribed as jottings on notecards, traces on photographic emulsions, entries in lab notebooks, or digital information, data supply the essential raw materials for all further scientific activity, from observing to theorizing. It is a category considered too basic to merit a history, too innocent to deserve a philosophy.

Yet no other aspect of science has commanded a greater commitment of ingenuity, resources, and sheer tenacity than the taking, making, and keeping of data. Since ancient times, cultures dispersed across the globe have launched monumental data-centered projects: the massive collections of astronomical observations in ancient China and Mesopotamia, the great libraries from Alexandria to Google Book Search, the vast networks of scientific surveillance of the world’s oceans and atmosphere, the mapping of every nook and cranny of heaven and earth.

The sciences of the archive embrace both the human and the natural sciences: history and astronomy, meteorology and archaeology. All sciences make some use of data, but the sciences of the archive are defined by it—and their practices in turn define what data mean. The history of the sciences of the archive raises questions about the evolution of categories such as “data,” “information,” and “knowledge”; the cultural preconditions for titanic undertakings that project themselves in imagination far into the future; the modalities of classification, from the physical arrangement of books on library shelves to the digital indexing of the data sent by space probes; the fantasy of completeness, whether expressed in a photograph or a museum collection; the techniques for registering and manipulation of information, from the table to the database.

Joseph Arnold, “*Cabinet of Art and Rarities of the Regensburg Iron Dealer and Mining Family Dimpfel*” (1668), Ulmer Museum, Ulm, Germany



The Sciences of the Archive
Working Groups

Documenting the World

January 8–9, 2010 and June 20–25, 2011

ORGANIZERS *Gregg Mitman* (University of Wisconsin-Madison USA),
Kelley Wilder (MPIWG/De Montfort University Leicester UK)

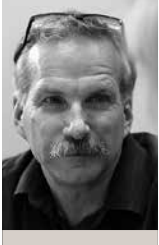

Gregg Mitman



Kelley Wilder

This Working Group investigated how photographic and filmic documents, through their creation and circulation, continually shape and reformulate the status of the archive. The resulting volume, edited by Gregg Mitman and Kelley Wilder, will be published by the University of Chicago Press in 2014. It addresses photographic and filmic documents drawn from a wide variety of archives, ranging from the files of Mars Rover Mission scientists to the private collection of the 1926 Harvard African

Expedition, from the tunnels of Corbis's Iron Mountain storage facility to the Nazi films and photographs made of disabled persons. Scholars from the fields of anthropology, history of science, photographic history, science and technology studies, media studies, art history, and archaeology come together in the volume to address the making, archiving, circulation, and recirculation of these photographic and filmic documents. Their contributions highlight the sheer excesses, both physical and ideological, of today's film and photographic archives.



Reproductions of Michelangelo's 'David',
 Kunsthistorisches Institut
 (Max Planck Institute), Florence, Italy.

Table of Contents

- Gregg Mitman and Kelley Wilder, *Introduction*
- Jennifer Tucker, *Photographic Proof in the Age of Mechanical Reproduction*
- Peter Geimer, *The Colors of Evidence: Picturing the Past in Photography and Film*
- Janet Vertesi, *Mars in the Making: Digital Documentary Practices in Contemporary Planetary Science*
- Elizabeth Edwards, *Uncertain Knowledge: Photography and the Turn-of-the-Century Anthropological Document*
- Gregg Mitman, *A Journey Without Maps: Film, Expeditionary Science, and the Growth of Development*
- Faye Ginsburg, *Archival Exposure: Disability, Documentary, and the Making of Counter-Narratives*
- Stefanie Klamm, *Reverse – Cardboard – Print: The Materiality of the Photographic Archive and Its Function*
- Kelley Wilder, *Photographic Cataloguing*
- Estelle Blaschke, *The Excess of the Archive*

Endangerment and Its Consequences

October 14–15, 2011 and July 17–19, 2012

ORGANIZERS *Nélia Días* (University of Lisbon, Portugal),
Fernando Vidal (MPIWG/ICREA, Universitat Autònoma de Barcelona, Spain)

“Endangerment” stands at the heart of a network of concepts, values, and practices dealing with objects threatened by disappearance, and with the devices, such as archives, catalogs, and databases, aimed at preserving them. It thus opens the way for examining the construction of data deemed significant, the kind of knowledge such data constitutes, the conceptual and institutional structures into which it is organized, the affects that permeate it, and the moral and epistemic values it incarnates. Protecting the endangered and memorializing the extinct assume that the objects to be safeguarded or remembered are valuable; these are often associated with a supposedly original state, and sometimes (as in the case of cultures and languages) with a condition of primeval authenticity. Architectural patrimony conserved in photographs, extinguished species in museum displays, or dead dialects in recordings nurture nostalgia for a more diverse world, and may give rise to resuscitation fantasies. The project “Endangerment and Its Consequences” examines the rise of the notion of endangerment in various contexts, from the preservation of biocultural biodiversity to the protection of languages and the conservation of material heritages, in a multi-authored volume.



Nélia Días



Fernando Vidal



Table of Contents

- Fernando Vidal, Nélia Días, *Introduction: Notes on the “Endangerment Sensibility”*
- Stefan Bargheer, *Conserving the Future: UNESCO Biosphere Reserves as Laboratories for Sustainable Development*
- Etienne Benson, *The Regulatory Archive: Conservation Biology and the State of Endangerment*
- Joshua Berson, *Archiving Indigeneity: Language Documentation and the Pragmatics of Decolonization*
- Stefanie Gänger, *The Last of His Kind: Endangerment and Indigeneity in the Conquest of Araucanía, 1879–1882*
- Ursula K. Heise, *Factory Farms and Mass Extinction: Two Views of Animals at Risk*
- Rebecca Lemov, *Endangered Data in the Postwar Social Sciences: From Anthropological Objects to Psychological Data Banks*
- José-Augusto Pádua, *From Hindrance to Biodiversity Treasure: The Rise of the Perception of Tropical Forests as a Valuable and Endangered Resource in Brazilian Political Culture*
- Irina Podgorny, *The Archaeology of “New Fossils” in the Decade of 1860: The Great Auk, Game Books, and the Register of Historic Extinctions*
- Joanna Radin, *Endangerment on Ice: Putting the Garden in the Machine*
- David Sepkoski, *Extinction, Diversity, and Endangerment*
- Julia Adeney Thomas, *Who Is the “We” Endangered by Climate Change?*

UNESCO interactive Atlas of the World’s Languages in Danger. Detail of Brazil showing languages, color-coded according to “vitality”, from extinct (black) to vulnerable (white).

The Sciences of the Archive

Planned Working Groups

The Archives of Deep-Time Sciences

ORGANIZER *Lorraine Daston* (MPIWG)

First meeting: July 2013

History is built into the natural and human sciences at different levels: some disciplines, such as geology and archaeology, deal with phenomena that are intrinsically historical; others, such as sociology and mathematics, use their own disciplinary genealogies to create canons of classical texts or eponymous theorems; still others, most in fact, accumulate disciplinary lore — anecdotes with which to initiate novices and heroes to honor with jubilee volumes. But for some sciences, history enters at the archival level: they depend on collections of data and objects in order to pursue research in the present and ensure the possibility of research in the future. The type specimens enshrined by botanists, the core samples drilled by geologists, the ancient observations still referred to by astronomers, the data banks assembled by biologists, the museum collections that hold the corpora of art historians and archaeologists, the parish records consulted by demographers, the voice recordings hoarded by linguists, and of course the libraries and archives visited by historians: these sorts of collections define the sciences of the archive. As these examples suggest, these sciences study the natural as well as the human realms. The practices of collecting, classifying, and preserving are common to both, and there is no presumption that the items collected, the

institutions that preserve them, or the methods that make use of them line up along the two-culture divide. The archival practices of the sciences remap the divisions of knowledge. Many but not all sciences of the archive study phenomena that unfold on a superhuman timescale: geology and astronomy are obvious examples. But other data-hungry sciences of the archive, like genetics, see no need to reach back into the deep past: terabytes of information about the present will serve as well for their meta-analyses. What all sciences of the archive have in common is not past- but rather future-consciousness: they imagine the archives that they have taken such pains to amass and conserve as a bequest to their successors, to the archaeologists, astronomers, geneticists, geologists, and demographers of the future.

Carduus sp. (LINN 966.34). Digitalized specimen from Linnaeus's herbarium. The Linnean Society of London Collections.



Historicizing Big Data

ORGANIZERS *Elena Aronova* (MPIWG),
Christine von Oertzen (MPIWG), *David Sepkoski* (MPIWG)
Preparatory conference: October 2013

Since the late twentieth century, huge databases have become a ubiquitous feature of science. The purpose of this Working Group is to historicize the emergence of so-called Big Data in modern science by exploring the material cultures, epistemologies, politics, and practices of data in a broad historical context. This undertaking includes examining the development of information processing technologies (whether paper-based or mechanical) and historicizing the relationships between collections of physical objects and collections of data. A history of data depends on an understanding of the tools and technologies used to collect, store, and analyze data that make data-driven science possible. Although Big Data is most often associated with the era of computer databases, there exist important continuities with data practices stretching back to the eighteenth century and earlier. The very notion of size — of “bigness” — is also contingent on historical factors that need to be contextualized and problematized. In the era following World War II, new technologies have emerged that allow new kinds of data analysis and ever larger data production. In addition, a new cultural and political context has shaped and defined the meaning, significance, and politics of data-driven science in the Cold War and beyond. “Historicizing Big Data” provides comparative breadth and historical depth to the ongoing discussion of the revolutionary potential of data-intensive modes of knowledge production and the challenges that the current “data deluge” poses to society.



U.S. Census Bureau machines and operators, 1908. Library of Congress Prints and Photographs Collections, Division Washington, D.C.

The Sciences of the Archive

Conferences

Machines of Memory: Archival Technologies and the Genealogy of Datapower (17th–20th Centuries)

October 15–16, 2010

ORGANIZER *Grégoire Chamayou* (MPIWG)

Most societies are currently experiencing the deployment of an archival kind of power — a “datapower” — that operates through the recording, storing, and retrieving of data, on a gigantic and ubiquitous scale. The goal of the workshop was to draw the link between the history of techniques of archiving and the formation of new ways of managing men, animals, and things — to sketch a genealogy of datapower by means of its technological history. The workshop’s participants, focusing on the seventeenth to twentieth centuries, explored a range of archiving technologies, including the history of the card-filing systems or traceability devices in heterogeneous fields of practices, the archives of cattle management, and the use of archiving devices within the arts of governance. These material apparatuses crystallize a whole set of social relationships, political rationalities, and aspirations to know ever more.

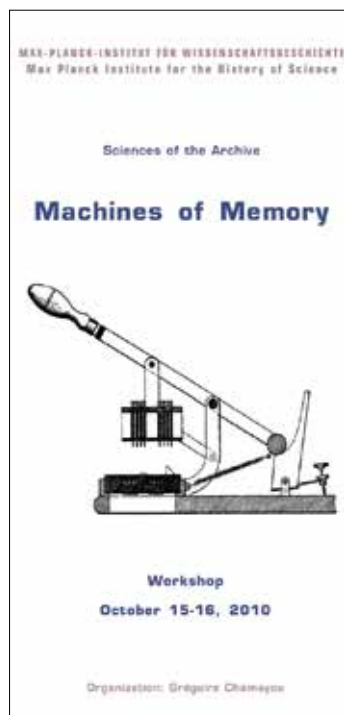

Participants

- *Susanne Bauer* (MPIWG/Johann Wolfgang Goethe Universität Frankfurt, Germany)
- *Dan Bouk* (Colgate University, USA)
- *Alejandra Bronfman* (University of British Columbia, Canada)
- *Grégoire Chamayou* (MPIWG/CNRS, Paris, France)
- *Donna Drucker* (Indiana University, USA)
- *Jean-Baptiste Fressoz* (Harvard University, USA)
- *Chihyung Jeon* (MPIWG/Korean Advanced Institute of Science and Technology, Seoul, Korea)
- *Markus Krajewski* (Bauhaus University Weimar, Germany)
- *Sophie Ledebur-Wicheln* (Charité Berlin, Germany)
- *Andreas Mayer* (MPIWG)
- *Christine von Oertzen* (MPIWG)
- *Armin Schäfer* (Max Planck Institute for the Study of Societies, Cologne, Germany)
- *Anton Tantner* (University of Vienna, Austria)

Thinking With Tables

March 12–14, 2012

ORGANIZERS *Karine Chemla* (Université Paris 7, Paris, France),
Lorraine Daston (MPIWG)

Tables and the closely related genre of lists are the most ancient and culturally widespread devices for displaying, manipulating, and preserving data. As such, they are the first (and sometimes final) archives of many sciences. Each workshop participant brought an exemplary table (the contexts ranged from ancient China to nineteenth-century Europe; the disciplines included astronomy, mathematics, physics, grammar, and pedagogy) in order to exhibit the versatility of such devices and to stimulate more general reflections on their uses and epistemic implications.



Participants

- *Domenico Bertoloni Meli* (Indiana University, USA)
- *Maarten Bullynck* (Université Paris 8, France)
- *Karine Chemla* (Université Paris 7, Paris, France)
- *Gerd Graßhoff* (Humboldt-Universität zu Berlin, Germany)
- *Agathe Keller* (Laboratoire SPHERE, CNRS, Paris, France)
- *Richard Kremer* (Dartmouth College, USA)
- *Mathieu Ossendrijver* (New York University, USA)
- *Christine Proust* (Laboratoire SPHERE, CNRS, Paris, France)
- *Friedrich Steinle* (Technische Universität Berlin, Germany)
- *Dominique Tournès* (Université de la Réunion/CNRS, France)

Regulating Research

March 16–17, 2012

ORGANIZER *Etienne Benson* (MPIWG)

Few scientists today, regardless of which field they work in, are exempt from regulations of one kind or another. Physicists and chemists are subject to safety standards for hazardous materials, biomedical researchers must seek informed consent from human subjects and meet minimal standards of animal welfare, field biologists need permits to capture or kill members of endangered species or to conduct studies in protected areas, and anthropologists and archaeologists are increasingly required to obtain consent from their research subjects or their descendants before conducting ethnographies or collecting artifacts. Permits, licenses, and review boards have become as integral to scientific research as specialized training, financial support, and instrumentation. This workshop brought together historians, anthropologists, sociologists, and legal scholars to address questions about the history, nature, and limits of the regulation of research across a variety of scientific disciplines and national contexts since the beginning of the twentieth century. Different research practices, ethical frameworks, and national contexts have led to divergent regulatory regimes for different sciences. Research on genetically modified organisms is regulated differently in the United States than in Sweden, for example, and in both places it is regulated differently than research on endangered species. The informational aspects of regulation as a technique of governance generate vast quantities of documents, which both draw on and directly shape processes of knowledge production.

Participants

- *Etienne Benson* (MPIWG)
- *Jorge Urzúa Contreras* (American University, Washington, D.C., USA)
- *Angela Creager* (Princeton University, USA)
- *Jenny Eklöf* (Umeå University, Sweden)
- *Johanna Gonçalves Martín* (University of Cambridge, UK)
- *Sheila Jasanoff* (Harvard University, USA)
- *Carsten Reinhardt* (University of Bielefeld, Germany)
- *Catherine Rémy* (CNRS/Mines ParisTech, France)
- *Diana Schmidt-Pfister* (University of Konstanz, Germany)
- *Ryan Shapiro* (Massachusetts Institute of Technology, USA)
- *Hilary Sonderland* (attorney/independent scholar, Seattle, USA)
- *Laura Stark* (Wesleyan University, USA)
- *Brian Wynne* (Lancaster University, UK)

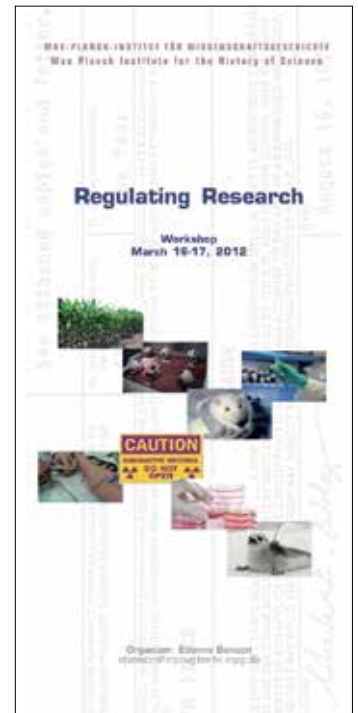

The Sciences of the Archive
Individual Projects



Elena Aronova

Elena Aronova (Research Scholar, MPIWG)

Big Science in the Archive: Managing Big Data in America and the Soviet Union During the Cold War

The history of the World Data Centers in the United States and the Soviet Union, from the organization of Data Centers during the International Geophysical Year (IGY) in 1957/58 to their reorganization and activities pursued after the IGY came to an end, provides a window onto the politics of worldwide data collection and data exchange in the age of the Cold War. The comparative history of the World Data Centers provides a vantage point for examining the practices and the politics of global data collection as well as their transformations following changes in the technologies of data management and in the wake of changes in the political climate on both sides

of the Iron Curtain. The IGY represented a distinct model of Big Science, driven by data and distinguished by the emphasis on data collection as an end in itself. The World Data Centers were the only institutionalized form of the IGY activities, and they developed during the 1960s into what might be called the “Archive of Big Science”—a big distributed archive for earth sciences, as well as a model of international scientific collaboration in the charged political climate of the Cold War.



All-sky camera designed during the IGY to photograph active aurora bands. From: Robert H. Eather, *Majestic Lights. The Aurora in Science, History, and the Arts*, Washington (1980), p. 176.



Etienne Benson

Etienne Benson (Research Scholar, MPIWG)

The Regulatory Archive: Science, Law, and Ethics in Biodiversity Conservation

The rise of the sciences of biodiversity in the late twentieth century was closely tied to the collection, organization, and dissemination of biological and ecological data. Endangered species, for example, were the subject of intensive research efforts aimed at documenting life histories and population dynamics. The results of this research were fed into the databases of international organizations such as the International Union for the Conservation of Nature and national agencies such as the U.S. Fish and Wildlife Service and National Marine Fisheries Service. On the basis of these data and their interpretation by experts, nongovernmental organizations and government agencies together shaped the future paths of both conservation and conservation biology—that is, of what was to be protected and what could be known about it.

In the scientific realm, the designation of certain species as



First intensive study of the grizzly bears of Yellowstone National Park by John and Frank Craighead. Courtesy of the Craighead Archives/John and Frank Craighead.

endangered with extinction had transformative effects, incentivizing research on those species while also placing new constraints on the methods that could be used to pursue them. This project examines the intersection of science, ethics, and law in biodiversity research since the 1960s. It uses archival research methods as well as the quantification and mapping of research activities as reflected in regulatory documents to show how biodiversity conservation, regulatory governance, and the databases upon which they depended and to which they gave rise helped determine what can be known about the natural world.

Joshua Berson (Postdoctoral Fellow, MPIWG)

Archiving Indigeneity: Language Documentation and the Pragmatics of Decolonization

Over the past 120 years, language has become subject to archiving. One consequence is that today, languages and linguistic diversity, like species of flora and fauna and biological diversity, are understood as scarce resources, the conservation of which is a matter of environmental and political urgency. In Australia, the focus of this project, land claims commissions and native title courts have, since the start of the land claims process in the 1970s, relied on linguistic field data to authenticate indigenous claims to land. At the international level, the law of self-determination, since its inception in the 1920s, has been guided by a theory that peoples, populations deserving of political and territorial autonomy, are to be defined by a handful of essential properties, of which monolingual shared speech is regarded as the most obvious. This project represents a critical interrogation of language endangerment and an inquiry into what language documentation means to linguists, anthropologists, cognitive scientists, policymakers, indigenous cultural revitalization activists, and interested publics.



Joshua Berson



Detail of linguistic map, Cape York Peninsula and the Gulf of Carpentaria. From: Wilhelm Schmidt, *Die Gliederung der australischen Sprachen* (1919).



Dan Bouk

Dan Bouk (Postdoctoral Fellow, Colgate University, USA)

How Our Days Became Numbered: The Development of a Statistical Infrastructure of Risk in the United States, 1873–1935

In the late 1930s, merchants in the United States began marketing a new kind of wallet: one with room for cards as well as cash. The social security card provided the first impetus, but soon enough would follow insurance cards, driver’s licenses, and, ultimately, credit cards. All of these cards had one thing in common, something more significant than their common residence in new wallets. Each signified membership in a new kind of national community: a statistical community grounded in vast databases (like the one instantiated in the Social Security Administration’s card files pictured here), equipped to track individual Americans’ behaviors over their lifetimes and to measure and price individual “risk.” These were important databases, each capable of opening — or closing — the door to health, wealth, and opportunity. This project explains the unknown origins in the life insurance industry of the statistical infrastructure undergirding these new cards and the communities they created. Today, this statistical system continues to shape the way Americans get — or fail to get — credit cards, health insurance, and welfare; it encourages individuals to conceive of their lives in dollars and of their futures in terms of risk factors; and it undergirds the databases that record Americans’ existences, whether kept by the Social Security Administration or Facebook.



Workers at the Social Security Records Office in Baltimore sorting the so called holding file (1937). Library of Congress Prints and Photographs Division Washington, D.C.



Mirjam Brusius

Mirjam Brusius (Postdoctoral Fellow, MPIWG)

The Canon under Threat: Objects without Status and Processes of (De) canonisation of Middle Eastern Archaeological Finds in 19th-century Europe

Taking the excavations by Austen Henry Layard (1817–1894) in ancient Mesopotamia as a starting point, this project examines the transit of objects between different canonical spaces, that is, the relationship between archaeological objects found at the excavation site and attempts to shift and incorporate them into European canonical and scholarly traditions in London, Paris and Berlin. The historiography of archaeology as a deep-time science has hitherto failed to help us understand how European canons and values are the result of a complex transfer in which archaeological objects



move from one canonical space to another. Research on the excavations and their reception in Europe has mostly drawn a picture of a well-organised, purposive and logical enterprise in which finding objects and depicting them had a clear purpose. Little attention has been paid to the fact that the exca-

Classifying the bricks from Babylon in the colonnades of the Alte Nationalgalerie, 1927/1928. Staatliche Museen zu Berlin.

vated items were initially objects without a clear status, even once they arrived in Europe. The goal of this project is to show how archaeological objects came to gain meaning as archival data for knowledge production and the formation of canonical traditions at European museums and universities. It will explore how the application of visual media in the field and the museum was both a reflection and a means of this enterprise.

Lorraine Daston (Director, MPIWG)

The Practices of Compendia

During the nineteenth century, both the natural and the human sciences pursued projects of collecting objects and data on an unprecedented scale: the *Corpus Inscriptionum Latinarum* of the philologists, the *Carte du Ciel* of the astronomers, the vast botanical collections of Kew Gardens in imperial Britain, the fossils amassed by the *Muséum d'histoire naturelle* in Paris, and the *Monumenta Germaniae Historica* of the medievalists. These undertakings were vast in scope, collective in authorship, and long, very long, in the making. Their media range from the multivolume edition (217 volumes for the *Patrologia latina*) to glass photographic plates (some 22,000 of them) to drawers of fossil specimens (too many to count). These are the practices of compendia that humanists and scientists share: for example, collecting, collating, and conserving large troves of data — whether in the form of manuscripts, books, specimens, illustrated atlases, or databases. The rise of the database and the Internet has intensified the links between the practices of those branches of the sciences and the humanities that depend crucially on large compendia. This project traces the evolution of the practices of compendia since the nineteenth century and their implications for rethinking the modern classification of the disciplines.



Lorraine Daston

Filing cabinet for the *Acta Borussica*, a monolithic editing project to document the history of Prussia, initiated by Gustav Schmoller in 1887. Geheimes Staatsarchiv Preußischer Kulturbesitz Berlin.

Markus Friedrich (Visiting Scholar, Johann Wolfgang Goethe Universität, Frankfurt, Germany)

Archival Culture in Early Modern Europe: New Approaches to an Old Topic

This project studies the rise of organized record-keeping from roughly 1450 to 1789, when archives gained prominence in Europe. Four methodological assumptions guide the project: First, the rise and existence of archives must be thoroughly historicized. Second, archives have to be understood as enormous challenges to Europe's conceptual and social fabric. Third, the impact of archives on European culture must be studied on a practical level. Fourth, archives were potentially dysfunctional or even counterproductive institutions. All too often, historical assessments simply assume that archives per se increased efficiency. Archives became part of the European myth of rationalizing progress. Yet this understanding is only rarely justified. Highlighting the contradictions, shortcomings, and weaknesses of archives will therefore



Markus Friedrich

be a crucial aspect of this project. *Archive in der Frühen Neuzeit: Bedeutung und Benutzung eines europäischen Wissensortes in Deutschland und Frankreich* will be published by Oldenbourg Verlag in Munich in 2013.



Chihyung Jeon

Chihyung Jeon (Postdoctoral Fellow, MIT, USA)

Anthropometric Data Banks and the Making of the Dimensional Body

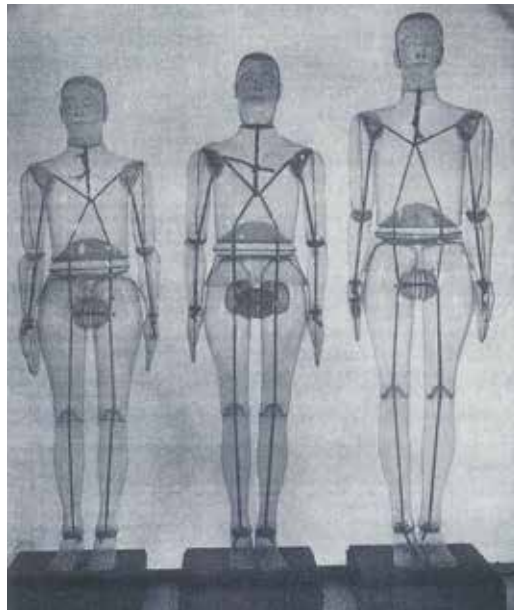

What does it take to create an archive of human forms and their interactions with machinery? And how does the human body come into being as an engineering object through this archiving practice? As more people have filled the position of a machine operator in vehicles, factories, and offices in both military and civilian sectors, especially since the mid-twentieth century, the human body has been shaped into a dimensional entity to be measured, classified, and managed before being put in front of a machine. This project on the history of engineering

Anthropometric manikins from the US Army Air Forces survey. From: Francis Randall et al., *Human Body Size in Military Aircraft and Personal Equipment* (1946), p. 196.

anthropometry from World War II to the present examines how this subdiscipline within human factors engineering or ergonomics has developed instruments and techniques of measuring human body dimensions specifically for close contact with machines and equipment.



Rebecca Lemov

Rebecca Lemov (Visiting Scholar, Harvard University, USA)

Database of Dreams: Toward a Science of the Ephemeral Human, 1941–1962

The “Database of Dreams” is a vast yet almost entirely forgotten archive. Built in 1955, it holds the collected records of people’s inner lives: their dreams, their life histories, their psychological test results, and even their hallucinogenic experiences, all gathered together in the middle of the twentieth century, shrunk into dollhouse size, and stored in the then most-modern data-collecting format, the Microcard. These “subjective materials” came from around the world, from South Pacific islanders to Pathan frontier villagers to the



Figurative representation of a dream from a Micronesian man named Avoligar, as recorded in 1947 by anthropologist Melford Spiro. CIMA Project, National Academy of Sciences-National Research Council (NAS-NRC) Archives, Washington, D.C.

Sioux Indians of the American West. Engineered to be accessible at any library in the world by means of the futuristic READEX machine or its handheld pocket-sized reader, the resultant data bank was poised to remake the social sciences and cutting-edge data-storage practices more generally. It pioneered the gathering of personal data in large amounts, a practice that has only grown astronomically in scale and scope since then. To tell this story, and to discover what lies within this trove of 20,000 unknown pages, is also to tell in miniature the story of the cataclysmic yet day-to-day arrival of the modern world in some of its more faraway places. How did scientists try to measure and gain some control over vast changes taking place in others — and also in themselves?

Christine von Oertzen (Research Scholar, MPIWG)

The Science of Statistics and the Politics of Census-Taking

This project tracks the transition from manual to machine data processing across Europe. The electronic tabulating machine appealed much more to some societies than others. Where concerns about migration were significant, frontiers uncertain, and ethnic divisions tangible, machine readability found strong advocates in central governments: in Washington, D.C. thanks to the efforts of one Hermann Hollerith, but also in Budapest, St. Petersburg, and Vienna. In Berlin, the Prussian statistical bureau remained firmly committed to the rationalities of state paternalism until the eve of World War I, employing some two thousand war invalids strewn across the city, all toiling on a strictly piece-rate basis. By 1914, the archiving and correlating of census data in Vienna, in contrast, was an entirely different affair, requiring much greater advance planning, a much less skilled but centralized workforce, and, not least, significant outlays of capital to keep the tabulating machines running: machines that could interpret untold reams of punch cards. In the German Empire, the unprecedented challenges brought about by World War I prompted an about-face toward big data machinery.



Christine von Oertzen

b) Zweck die Zählung zur maßstablichen Zählung vorbereitete Beiliste.

PERSONENSTATISTIK				HAUSHALTUNGSSTATISTIK								WOHNUNGSSTATISTIK			
Zählort	Geb. Jahr	Arbeitsort		Kind.	Leh. Vorw.	Ung. Arb.	Hinterb.	Diensth.	and. Pers.	Wohnraum	Schlafst.				
OA	Dec. 1	OA		0	0	0	0	0	0	0	0	0	0		
1	1	1	1	1	1	1	1	1	1	1	1	1	1		
2	2	2	2	2	2	2	2	2	2	2	2	2	2		
3	3	3	3	3	3	3	3	3	3	3	3	3	3		
4	4	4	4	4	4	4	4	4	4	4	4	4	4		
5	5	5	5	5	5	5	5	5	5	5	5	5	5		
6	6	6	6	6	6	6	6	6	6	6	6	6	6		
7	7	7	7	7	7	7	7	7	7	7	7	7	7		
8	8	8	8	8	8	8	8	8	8	8	8	8	8		
9	9	9	9	9	9	9	9	9	9	9	9	9	9		

Württembergische Volkszählung 1910. In Wohnung überlitten? JA

First punch card used in a German census, 1910. From: Hermann Julius Losch, *Die Volkszählung vom 1. Dezember 1910* (1911), p. 184.



David Sepkoski

David Sepkoski (Research Scholar, MPIWG)

A Natural History of Data

The project examines the changing practices and epistemologies surrounding data in the natural historical disciplines from 1800 to the present. One feature of this transformation is the emergence of the modern digital database as the locus of scientific inquiry and practice, and the consensus that we are now living in an era of “data-driven” science. However, this project also critically examines this development in order to historicize our modern fascination with data and databases — starting with paleontology and broadening the scope to include geology, paleoanthropology, archaeology, zoology, and botany. The following questions guide the inquiry: What is

the relationship between data and the physical objects, phenomena, or experiences that they represent? How have tools and available technologies changed the epistemology and practice of data over the past two hundred years? What are the consequences of the increasing economies of scale as ever more massive data collections are assembled? Have new technologies of data changed the very meaning and ontology of data itself? How have changes in scientific representations occurred in conjunction with the evolution of data practices (e.g., diagrams, graphs, photographs, atlases, compendia)? And, ultimately, is there something fundamentally new about the modern era of science in its relationship to and reliance on data and databases?

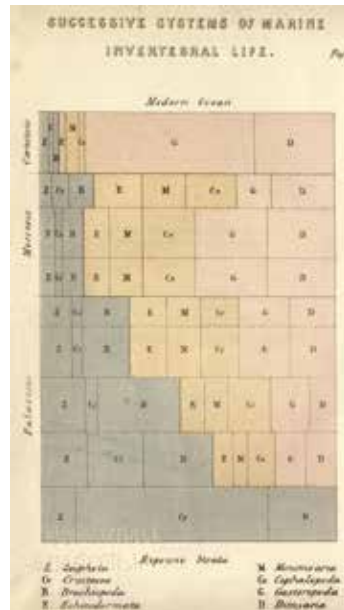

Frontispiece, representing “the relative proportions of the several classes in successive geological periods.”

John Phillips, *Life on the Earth; Its Origin and Succession* (1860).

The Sciences of the Archive

Short-Term Visiting Scholars

Jean-Marc Besse (Université Paris I, France), *Charlotte Bigg* (Centre Alexandre Koyré, Paris, France), *Andrea Bréard* (Université de Lille, France), *Jane Caplan* (University of Oxford, UK), *Alex Csiszar* (Harvard University, USA), *Martha Fleming* (London, UK), *Courtney Fullilove* (Wesleyan University, USA), *Florence Hsia* (University of Wisconsin-Madison, USA), *Vladimir Jankovic* (University of Manchester, UK), *Markus Krajewski* (Bauhaus-Universität Weimar, Germany), *Sarah Igo* (Vanderbilt University, USA), *Richard Kremer* (Dartmouth College, USA), *Ursula Kundert* (Universität Kiel, Germany), *Ilana Löwy* (CERMES, Villejuif, France), *Marlene Manoff* (Massachusetts Institute of Technology, USA), *Christer Nordlund* (Umeå University, Sweden), *Carla Nappi* (University of British Columbia, Canada), *Christine Ottner-Diesenberger* (Universität Wien, Austria), *Kim Plofker* (Union College, USA), *Dhruv Raina* (Jawaharal Nehru University, India), *Carsten Reinhardt* (Universität Bielefeld, Germany), *André Wakefield* (Pitzer College, USA), *Per Wisselgren* (Umeå University, Sweden)

Project

Between the Natural and the Human Sciences

ORGANIZERS *Lorraine Daston* (MPIWG), *Andreas Mayer* (MPIWG),
Fernando Vidal (MPIWG/ICREA, Universitat Autònoma de Barcelona, Spain)

COOPERATION PARTNERS Universidade do Estado do Rio de Janeiro/UERJ
(Brazil), Centre Alexandre Koyré (France), University of Chicago (USA), London
School of Economics (UK), Humboldt-Universität zu Berlin (Germany),
Wissenschaftskolleg zu Berlin (Germany), American Academy in Rome (Italy)

Questions about the history of kinds of knowledge, evidence, and objects are common to all the sciences, from astronomy to psychology, from meteorology to sociology. Yet the natural sciences have received immeasurably more historical and philosophical scrutiny than the human sciences, with the result that conceptions of knowledge—what it is, how to get it, what to do with it—are correspondingly lopsided. The division between the natural and the human sciences and the resulting neglect of the latter by historians and philosophers of science are the products of late nineteenth-century shifts in the classification of knowledge, which remapped the disciplines in order to sharpen the distinction between the human and the natural realms and therefore between the sciences dedicated to each. Although the methods and forms of explanation of, for example, evolutionary biology and historical sociology had more in common than either of them had with physics, on the one hand, or demography, on the other, the newly drawn boundary between the natural and the human sciences divided disciplines once linked by shared histories and practices. The projects conducted under this rubric investigate the historical and contemporary interactions between the human and the natural sciences, as well as their shared epistemic values, practices, and institutions, in order to create new models for the history of the human sciences.

Working Groups

Cold War Rationality

March 15–16, 2010; June 15–July 31, 2010; March 15–17, 2012

ORGANIZERS *Lorraine Daston* (MPIWG), *Michael D. Gordin* (Princeton University, USA)

A loose conglomerate of game theory, nuclear strategy, operations research, Bayesian decision theory, systems analysis, rational choice theory, and experimental social psychology, Cold War rationality in its heyday seemed the last, best hope for the unification of the human sciences and the recipe for their successful application to everything from diplomatic negotiations to agricultural price-setting to social stability. This brand of rationality was very much the product of a specific time and place: the



The "Red Telephone" at SAC Headquarters underground Command Post in Nebraska (1959). Photo Collage by Brian Arthur (2012).

United States at the height of the Cold War, roughly between the bombing of Hiroshima and Nagasaki in August 1945 and the early 1980s. The distinctive combination of stripped-down formalism, economic calculation, experimental microcosms, and towering ambitions that characterized Cold War rationality bore the stamp of an equally distinctive moment in the history of the American human sciences. Lavish funding, new institutions like the RAND Corporation which straddled university, military, and industry, networks woven by select summer schools and conferences, and, above all, the sense of urgency created by the threat of catastrophic war or even human annihilation — all of these set the stage for Cold War rationality. The multi-authored volume written collectively by this Working Group, *The Strange Career of Cold War Rationality*, will be published by University of Chicago Press in 2013.

Authors

Lorraine Daston, Paul Erickson, Michael Gordin, Judy Klein, Rebecca Lemov, Thomas Sturm

Table of Contents

Introduction: The Struggle over Cold War Rationality
 Chapter 1: Enlightenment Reason, Cold War Rationality, and the Rule of Rules
 Chapter 2: The Bounded Rationality of Cold War Operations Research
 Chapter 3: Saving the Planet from Nuclear Weapons and the Human Mind
 Chapter 4: “The Situation” in the Cold War Behavioral Sciences
 Chapter 5: World in a Matrix
 Chapter 6: The Collapse of Cold War Rationality
 Epilogue: Cold War Rationality after the Cold War



Giuseppe Arcimboldo, *The Librarian* (ca. 1560), Skokloster Castle, Sweden.

The Learned Practices of Canonical Texts: A Cross-Cultural Comparison

January 29–30, 2010 and July–August 2012

ORGANIZERS *Anthony Grafton* (Princeton University, USA), *Glenn W. Most* (Scuola Normale Superiore di Pisa, Italy/MPIWG), *András Németh* (MPIWG)

The creation of canons of written texts — religious, literary, philosophical, scientific — is a feature of numerous literate cultures from ancient times to the present. Such canons may crystallize cultural identities, confessional orthodoxies, school curricula, standards of taste and refinement, and/or the qualifications of ruling elites. They also give rise to learned textual practices, some of them quite technical, to stabilize, reproduce, store, access, format, correct, and interpret the canon. In ancient Chinese and ancient Greek, in medieval Arabic and medieval Latin, in Sanskrit and in Persian, in the modern European vernaculars since the Renaissance (to name only these), highly trained scholars have developed, cultivated, and transmitted the textual practices of their respective canons. These practices include source criticism, emendation, reconstruction, etymology, script, mise-en-page, indexing, specialized reading techniques, detection of forgeries, and much else. The virtuosi of textual practices have often been the leading intellectuals of their cultures, providing models and materials for other branches of learning. Shadowing and helping to shape the traditions gener-

ated by the canonical texts themselves are the learned traditions of the textual practices that serve the canon: the sciences of the text.

This project studies the textual practices of the guardians of the canons across multiple cultures and centuries. It examines historically and comparatively the scholarly practices associated with canonical texts, especially in the following linguistic traditions: Ugaritic, ancient Greek, Latin, Coptic, Hebrew, Arabic, the languages of the Indian subcontinent, and Chinese. Among scholarly practices, we focus on textual establishment and criticism; exegesis and commentary; lexicography; methods of excerpting, storage, and retrieval of texts; libraries and their uses. Building on recent work on the origins and cultural significance of canons, and following the example of historians of science and scholarship who have examined scientific practices such as collecting, measuring, and note-taking, the project investigates the distinctive practices that make texts objects of systematic inquiry. A collective publication is planned for 2014; Cambridge University Press has expressed strong interest.

Working Group Members

- *Guy Burak* (New York University, USA)
- *Lianbin Dai* (University of Oxford, UK)
- *Anthony Grafton* (Princeton University, USA)
- *Robert Kaster* (Princeton University, USA)
- *Megan McNamee* (University of Michigan, USA)
- *Christopher Minkowski* (University of Oxford, UK)
- *Paola Molino* (Universität Wien, Austria)
- *Glenn W. Most* (MPIWG/University of Chicago, USA/Scuola Normale Superiore di Pisa, Italy)
- *András Németh* (MPIWG)
- *Filippomaria Pontani* (University of Venice, Italy)
- *Ineke Sluiter* (Universiteit Leiden, The Netherlands)
- *Aaron Tugendhaft* (New York University, USA)
- *Paolo Visigalli* (University of Cambridge, UK)
- *Ronny Vollandt* (CNRS Section hébraïque, Paris, France)
- *Joanna Weinberg* (University of Oxford, UK)

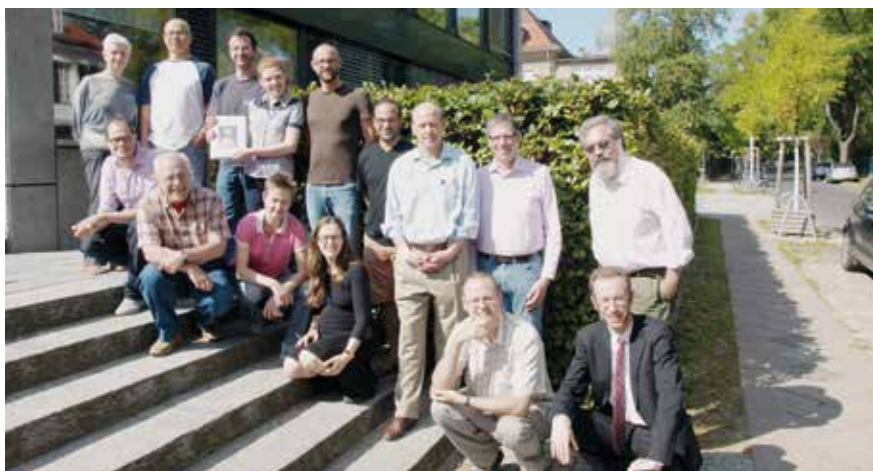

Members of the working group, summer 2012

Between the Natural and the Human Sciences

Completed Project**The Cerebral Subject: Brain, Self, and Body in Contemporary Culture**

DURATION 2004–2012

ORGANIZERS *Francisco Javier Guerrero Ortega* (Universidade do Estado do Rio de Janeiro/UERJ, Brazil), *Fernando Vidal* (MPIWG/ICREA, Universitat Autònoma de Barcelona, Spain)



Francisco Ortega



Fernando Vidal

The goal of this project was to study the emergence, functioning, and topography in contemporary culture of the idea, epitomized by the expression *cerebral subject*, that human beings are constituted essentially by their brains. The cerebral subject has innumerable materializations within and outside philosophy, psychology, and the neurosciences. Since the 1990s, new disciplines such as neurotheology, neuroeducation, neuroesthetics, neuropsychanalysis, neuromarketing, and neuroeconomics have advanced bold plans to reform the human sciences on the basis of neuroscientific knowledge. Driven by the availability of brain imaging technologies, they focus on the quest for neural correlates of behaviors and mental processes. Parallel to academic approaches, there is an expanding galaxy of beliefs and practices that go from learning how to draw or feel with one side of the brain, to various forms of neurohealthism, neuroascetics, neuroesotericism, and neuroeschatology. The project approached these phenomena from different angles, mainly philosophical, historical, sociological, and anthropological, and in reference not only to science and medicine, but also to extra-scientific ideas and practices that ultimately concern the self and the definition of the human being.

Coordinated at MPIWG by Fernando Vidal (now at ICREA, the Catalan Institution for Research and Advanced Studies, Barcelona), “The Cerebral Subject” was a collaborative project run together with Francisco Ortega (IMS/Institute for Social Medicine, State University of Rio de Janeiro, Brasil). At MPIWG it involved cooperation with Suparna Choudhury (now at McGill University, Montreal, Canada) and Nicolas Langlitz (now at the New School for Social Research, New York, USA). It included a four-year IMS-MPIWG exchange program (2005–2008) funded by the DAAD (German Academic Exchange Service), and two international conferences: “The Neurosciences and Contemporary Society” (Rio de Janeiro, 2006) and “Neurocultures” (Berlin, 2009, co-organized with the BIOS Centre, London School of Economics). The collective volume *Neurocultures* (ed. F. Ortega and F. Vidal, 2011) contains contributions by some of the participants in those events. *Being Brains*, co-authored by F. Ortega and F. Vidal, will be published in the *Forms of Living* series of Fordham University Press.

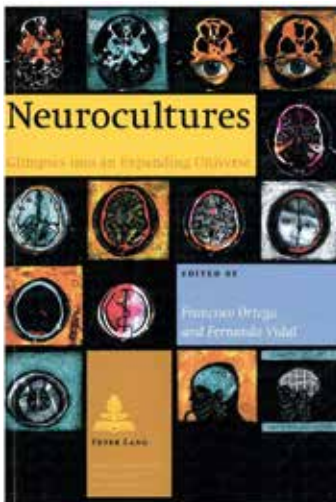

Between the Natural and the Human Sciences

Conferences**The Human Subject in the Human Sciences**

Chicago, April 2–3, 2010

ORGANIZERS *Lorraine Daston* (MPIWG), *Robert J. Richards* (University of Chicago, USA), *Alison Winter* (University of Chicago, USA)

COOPERATION PARTNER University of Chicago (USA)

Phenomena such as behavior, attitude, and consciousness are topics of experimental research for many of the fields of the human sciences. In some of them, how to manage the knowing human subject in order to study such phenomena has attracted sustained deliberations about method and procedure — for instance, about using deception to keep subjects' knowledge of the research from affecting results. Moreover, concerns about the possible effects of being a research subject, including worries about the mere knowledge of the course of this research, have figured in the increasingly elaborate institutional review protocols that oversee human subject research. In some fields, critics have posed questions about the cultural place of science in a democratic society. The workshop explored historical questions concerning the understandings of subjects in the human sciences, as well as how those understandings have been developed and put to use in practical settings; it also attempted to articulate the roles that the relation between researcher and human subject have played in the development of the modern human sciences.

Participants

- *Ken Alder* (Northwestern University, USA)
- *Felicity Callard* (MPIWG/University of Durham, UK)
- *Gregoire Chamayou* (MPIWG/CNRS, Paris, France)
- *Lorraine Daston* (MPIWG)
- *Steve Epstein* (Northwestern University, USA)
- *Jill Fisher* (Vanderbilt University, USA)
- *John Forrester* (University of Cambridge, UK)
- *Caitjan Gainty* (University of Chicago, USA)
- *Sarah Igo* (Vanderbilt University, USA)
- *Jennifer Karlin* (University of Chicago, USA)
- *Elizabeth Lunbeck* (Vanderbilt University, USA)
- *Emily Martin* (New York University, USA)
- *Andreas Mayer* (MPIWG)
- *Greg Mitman* (University of Wisconsin at Madison, USA)
- *Jill Morawski* (Wesleyan University, USA)
- *Zoe Nyssa* (University of Chicago, USA)
- *Laura Stark* (Wesleyan University, USA)
- *Alison Winter* (University of Chicago, USA)

Reading Against the Grain: National Historiographies in the Human Sciences As Seen from an Outsider Perspective

Paris, June 9–12, 2010

ORGANIZERS *Jacqueline Carroy* (Centre Alexandre Koyré, Paris, France),
Lorraine Daston (MPIWG), *Wolf Feuerhahn* (Centre Alexandre Koyré, Paris, France),
Jan Goldstein (University of Chicago, USA), *Andreas Mayer* (MPIWG)

COOPERATION PARTNERS University of Chicago Center Paris (France),
Centre Alexandre Koyré Paris (France)

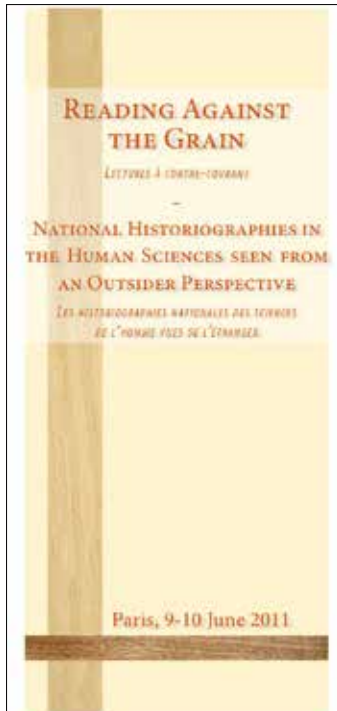

More than any other part of the history of science, the historiography of the human sciences (one might even say, the objects of inquiry in the human sciences) has been shaped by national traditions. But these traditions have not been parochial: there has been much reading, reflection, and refraction across boundaries of language and lineage. This workshop explored this paradoxical situation, which is illustrated, for example, by “British” readings of Freud, “French” readings of Weber, “German” readings of Durkheim, and “American” readings of Foucault. According to what criteria can we speak about “national” readings? What role does the national context play in the transfer of a work? To what extent do these readings modify the pre-existing national traditions? Participants examined the politics and practices of translation in each country and provided reflections on how their own work has drawn upon and adapted sources from other national traditions.

Participants

- *Jacqueline Carroy* (Centre Alexandre Koyré, Paris, France)
- *Lorraine Daston* (MPIWG)
- *Wolf Feuerhahn* (Centre Alexandre Koyré, Paris, France)
- *John Forrester* (University of Cambridge, UK)
- *Jan Goldstein* (University of Chicago, USA)
- *Jean-Pierre Lefebvre* (translator, Paris, France)
- *Andreas Mayer* (MPIWG)
- *Kapil Raj* (Centre Alexandre Koyré, Paris, France)
- *Nathalie Richard* (Université Paris I, France)
- *Robert J. Richards* (University of Chicago, USA)
- *Christian Topalov* (EHESS Paris, France)
- *Fernando Vidal* (MPIWG/ICREA, Universitat Autònoma de Barcelona, Spain)
- *Alison Winter* (University of Chicago, USA)

Freud’s Rome: Phobia and Phantasy

Villa Aurelia, American Academy in Rome, June 23–24, 2010

ORGANIZERS *Martin Brody* (American Academy, Rome), *Andreas Mayer* (MPIWG)

Instead of adopting the common format of a scientific conference, this event was structured, not unlike Freud’s *The Interpretation of Dreams*, as a walk where talks and discussions took place in the sites and in front of the monuments that incited the phobias, dreams, and fantasies which Freud dealt with in various texts. The walk led

from the hills of the Janiculum and the Aurelian walls to the bas-relief of the walking woman in the Chiaramonti collection in the Vatican Museum, known as “Gradiva,” to Michelangelo’s “Moses” at S. Pietro in Vincoli, and, finally, to the Forum Romanum. At a second authors’ workshop held in Berlin, texts were discussed and prepared for publication in a collective volume (forthcoming 2014).

Participants

- *Gerd Blum* (Kunstakademie Münster, Germany)
- *Martin Brody* (American Academy, Rome)
- *John Forrester* (University of Cambridge, UK)
- *Elizabeth Lunbeck* (Vanderbilt University, USA)
- *Andreas Mayer* (MPIWG)
- *Nathalie Richard* (Université Paris 1, France)

Measurement of Values

June 8–9, 2012

ORGANIZER *Stefan Bargheer* (MPIWG/University of California, Los Angeles, USA)

The study of values in the social sciences went through a period of substantial conceptual and institutional transformation between the late 1920s and the early 1960s. This workshop brought together scholars who examine this development in various scientific disciplines and different parts of the world by focusing on concepts such as preferences, attitudes, and (public) opinion, and their relation to large-scale data collection projects that range from central depositories for globally gathered ethnographic data to quantitative survey research.

Participants

- *Scott Anthony* (University of Cambridge, UK)
- *Stefan Bargheer* (MPIWG/University of California, Los Angeles, USA)
- *Joshua Derman* (Hong Kong University of Science and Technology, China)
- *Rainer Egloff* (Collegium Helveticum, Switzerland)
- *Paul Erickson* (Wesleyan University, USA)
- *Christian Fleck* (University of Graz, Austria)
- *Nathalie Heinich* (EHESS, Paris, France)
- *Steven Hitlin* (University of Iowa, USA)
- *Felix Keller* (University St. Gallen, Switzerland)
- *Rebecca Lemov* (Harvard University, USA)
- *Christopher Neumaier* (Universität of Mainz, Germany)
- *Anna Perlina* (MPIWG)
- *Alexandru Preda* (King’s College London, UK)

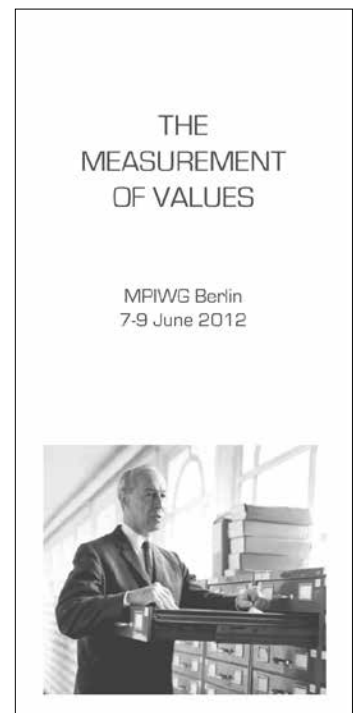

Celebrating the 50th Anniversary of Thomas Kuhn's *The Structure of Scientific Revolutions*

Chicago, November 30–December 1, 2012

ORGANIZERS *Karen Darling* (University of Chicago Press, USA),
Lorraine Daston (MPIWG), *Christie Henry* (University of Chicago Press, USA),
Robert J. Richards (University of Chicago, USA)

COOPERATION PARTNER University of Chicago and the University of Chicago Press (USA)

International Encyclopedia of Unified Science	
Volume 2 · Number 2	
The Structure of Scientific Revolutions	
Thomas S. Kuhn	
Contents:	
PREFACE	v
I. INTRODUCTION: A ROLE FOR HISTORY	1
II. THE ROUTE TO NORMAL SCIENCE	10
III. THE NATURE OF NORMAL SCIENCE	23
IV. NORMAL SCIENCE AS PUZZLE-SOLVING	35
V. THE PRIORITY OF PARADIGMS	43
VI. ANOMALY AND THE EMERGENCE OF SCIENTIFIC DISCOVERIES	52
VII. CRISIS AND THE EMERGENCE OF SCIENTIFIC THEORIES	66
VIII. THE RESPONSE TO CRISIS	77
IX. THE NATURE AND NECESSITY OF SCIENTIFIC REVOLUTIONS	92
X. REVOLUTIONS AS CHANGES OF WORLD VIEW	111
XI. THE INVULNERABILITY OF REVOLUTIONS	136
XII. THE RESOLUTION OF REVOLUTIONS	144
XIII. PROGRESS THROUGH REVOLUTIONS	160
POSTSCRIPT—1969	174
	iii

On the occasion of the fiftieth anniversary of what was arguably the most influential book published in the history of science during the twentieth century, philosophers, historians, and social scientists took stock of the book's origins, influence, and continued relevance. An exhibition of editions and translations of *The Structure of Scientific Revolutions*, as well as archival materials relating to its publication, was organized by the University of Chicago Press in cooperation with the Special Collections of the University of Chicago Library. The conference volume will be published by the University of Chicago Press.

Participants

- *Andrew Abbott* (University of Chicago, USA)
- *James Conant* (University of Chicago, USA)
- *Angela Creager* (Princeton University, USA)
- *Lorraine Daston* (MPIWG/University of Chicago, USA)
- *Peter Galison* (Harvard University, USA)
- *Daniel Garber* (Princeton University, USA)
- *Ronald Giere* (University of Minnesota, USA)
- *Ian Hacking* (University of Toronto, Canada)
- *David Kaiser* (Massachusetts Institute of Technology, USA)
- *Garrett Kiely* (University of Chicago Press, USA)
- *George Reisch* (Open Court Publishing Company, USA)
- *Robert J. Richards* (University of Chicago, USA)
- *Norton Wise* (University of California, Los Angeles, USA)

Between the Natural and the Human Sciences

External Conferences

Normativity

July 10–11, 2012

ORGANIZERS *James Conant* (University of Chicago/USA), *Lorraine Daston* (MPIWG)

COOPERATION PARTNER Wissenschaftskolleg zu Berlin (Germany)

Mathematics and the Transformation of Economics after 1945

November 9, 2012

ORGANIZER *Till Düppe* (Humboldt-Universität zu Berlin, Germany)

COOPERATION PARTNER Humboldt-Universität zu Berlin, Germany

Between the Natural and the Human Sciences

Individual Projects

Stefan Bargheer (Postdoctoral Fellow, MPIWG/University of California, Los Angeles, USA)

Biological Diversity and Cultural Pluralism: The Changing Valuation of Complexity in Nature and Culture in Germany and the United States

This project investigates how biologists and anthropologists in the United States and in Germany study complexity in nature and culture, and traces the emergence of separation between the two fields of inquiry from the 1920s to the 1980s.

At the beginning of the twentieth century, the then-dominant theory of evolution advanced a holistic notion of the relation between nature and culture that associated “primitive” peoples with nature (*Naturvölker*) and “civilized” people with culture (*Kulturvölker*). The diversity of primitive peoples was assumed to be related to the diversity of their natural environments, whereas civilized cultures were held to create their own built environments. Throughout the twentieth century, cultural phenomena were increasingly considered to be independent from their environments, whether built or found.

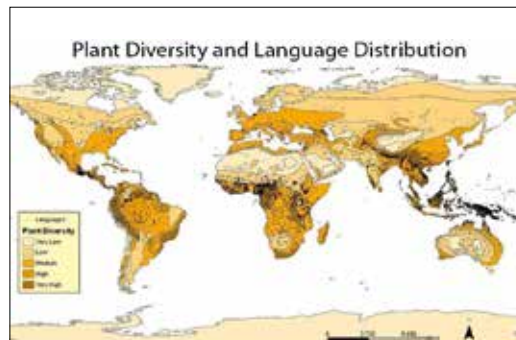

Stefan Bargheer

From: Stepp, J. R. et al., *Development of a GIS for Global Biocultural Diversity*. *Policy Matters* 13 (2004).

John Carson (Visiting Scholar, University of Michigan, Ann Arbor, USA)

Between Law and Science: Unsoundness of Mind in Anglo-American Medical Jurisprudence

Very different languages of mental deficiency and personal agency evolved within the legal and medical worlds during the nineteenth century. The project investigates the complicated ways in which concepts in one community were both connected to, and differentiated from, those in the other, and how each of these languages was particularized when applied by a variety of actors — including physicians, mental philosophers, asylum keepers, lawyers, judges, and legislators — to concrete situations and living individuals. The goal is to understand the process by which individuals were categorized according to their mental ability, the meaning of such categorizations when applied to specific situations, and the means by which knowledge generated and expertise validated in one context could, or could not, become persuasive within the other.



John Carson



Donatella Germanese

Donatella Germanese (Research Scholar, MPIWG)

Science and Technology in Italian Literary Journals, 1945–1967

Science and technology were surprisingly prominent in literary and cultural journals published in Italy after World War II. Absolute faith in scientific progress and the accusation of dehumanizing people and destroying the environment are the opposite ends of a broad range of positions we can find in essays, novels, and poems published in journals such as *Civiltà delle Macchine*, founded in 1953 by the poet, engineer, and marketing manager Leonardo Sinisgalli, and *il menabò*, edited by Elio Vittorini and Italo Calvino (1959–1967), who wanted to promote an “industrial literature” reflective of the effects produced by technology on every aspect of life, particularly on perception and language. Preliminary investigations point to several directions for in-depth analysis, such as exploring the concept of science implicit in the debates; the interrelation between international exchange and interest in scientific topics; the text translation policy of representative journals; the assimilation or the refusal of science and technology in literary works; the involvement of selected journals in Cold War science; and the conceptualization of man-made industrial reality — with implications for literature and art — anticipating current debates about the “Anthropocene.”



Italian literary publications of the Postwar period.



Andreas Mayer

Andreas Mayer (Research Scholar, MPIWG, funded by the Thyssen Stiftung, November 1, 2010 to October 31, 2012)

Dream Watchers: A History of Modern Dream Research

This project investigates the rise of the scientific study of dreams in Europe and the United States after 1850, focusing on the regimes of observation in three overlapping eras. During the first period, the dream became the object of a new regime of self-

observation in which men of letters methodically recorded and collected their own nocturnal visions. In the second period, research on dreams gradually moved away from the method of self-observation by placing the emphasis on collective and comparative studies, often with the use of statistics, and by bringing dreams into strong association with the physiological investigation of sleep. In this context, Freud’s *The Interpretation of Dreams* (1900) emerged as a distinct enterprise. The method of self-analysis, the practical treatment of the dream as the dreamer’s recollection in the form of a narrative with the refusal of pictorial fixation, seems to set psychoanalysis apart from the objectifying practices of dream research. However, during the third stage, which saw the



Hervey de Saint-Denys, *Les rêves et les moyens de les diriger*, Frontispiece, Paris (1867).

parallel rise of psychoanalysis within the human sciences and of dream studies within the sleep laboratory, various significant overlaps between the two fields have become apparent.



András Németh (Research Scholar, MPIWG)

Imperial Systematization of the Past: Textual Practices and Canon Formation at the Byzantine Court

This project reconsiders the improved textual practices of the mid-tenth-century Byzantine imperial court and analyzes how these activities were linked with the imperial renewal of historiography. With a huge investment of financial and human resources, Emperor Constantine VII (r. 945–959) ordered reconstructions of complete works of dozens of ancient, Hellenistic, late antique, and Byzantine historians, following a peculiar yet well-defined method. Establishing a new canon of historiography required a vehicle of accumulation, reconstruction, and dissemination.

For Constantine VII, this vehicle was the re-establishment of the palace library, the palace school, and supervision of the production of manuscripts, which proved a major step in transmitting the classical heritage to the present day. The result is known as the Constantinian Excerpts, which were used in his imperial treatises and later in the Suda lexicon. So far these excerpts have been studied with the exclusive aim of recovering unknown events and revitalizing otherwise lost historical works. In contrast, this study attempts to survey the original purpose of this imperial project, its chronology, and its unique approach to systematizing accumulated knowledge.



András Németh

Ivory plaque with Constantine VII, 945.
Moscow, State Pushkin Museum of Fine Arts.

Dominique Pestre (Visiting Scholar, Ecole des Hautes Etudes en Sciences Sociales, Paris, France)

The Government of Techno-Science and Techno-Products at the Global Level

This collective project (six senior and a dozen junior scholars) deals with the government of techno-sciences and techno-industrial products since World War II, including the government of chemicals, of drugs and health, of nuclear business and radiation, of water and bio-security, of climate change and environmental questions. It deals with institutions, with an emphasis on global actors such as the UN agencies (FAO, WHO, UN Environmental Program), the OECD, the World Bank, and the WTO, as well as some NGOs and institutions put into place by major economic players (round tables, public-private partnerships). It also deals with the technologies that are used to monitor and govern, such as toxicology and epidemiology, modelling and simulations, inventories and indicators, economic instruments and calculus, the determination of norms and standards, evaluation and management of risks, participatory procedures, and the management of dissenters and public space.



Dominique Pestre



David Sepkoski

David Sepkoski (Research Scholar, MPIWG)

Extinction and the Value of Diversity

We can only fully appreciate why late twentieth-century culture became so invested in protecting and promoting diversity by more broadly investigating how ideas about biological and cultural extinction have changed over the past two hundred years. In the nineteenth century, diversity was not an independent value in scientific and political discourse in the West. The extinction of a biological species or a human culture was understood to be the result of natural selection, requiring no regret or intervention. However, in the mid-twentieth century, scientists learned that major mass extinction events had taken place many times in the earth's past, and that these events had radical evolutionary and ecological consequences. The modern concern with the "biodiversity crisis" emerged directly from this new scientific understanding of extinction, and it is now often said that we are experiencing a "sixth extinction." Furthermore, this discourse of biodiversity emerged at the same time as a broader public awareness of threats to linguistic and cultural diversity. The broader cultural value of diversity is significantly informed by the new understanding of extinction and its consequences, but this is the first historical account to explicitly bring these discourses together.



Cover of Time Magazine, May 6 (1985).



Cecelia Watson

Cecelia Watson (Postdoctoral Fellow, MPIWG/Haus der Kulturen der Welt, Berlin)

The Anthropocene Project

The Anthropocene hypothesis proposes that with the invention of James Watt's steam engine, the earth entered a new geologic era characterized by an unprecedented level of human intervention in natural processes. If man makes nature rather than being the passive object of its processes, what new ways of thinking can be generated with regard to long-standing questions in the arts and humanities? In turn, how can the

arts and humanities offer a critical perspective on the scientific theory behind the Anthropocene? In January 2013, the Haus der Kulturen der Welt (in cooperation with the Max Planck Society, the Deutsches Museum, and the Rachel Carson Center) launched the first of a series of exhibitions and events designed to interrogate, and experiment with, the idea of the Anthropocene, using it as a starting point for critical reflection across the

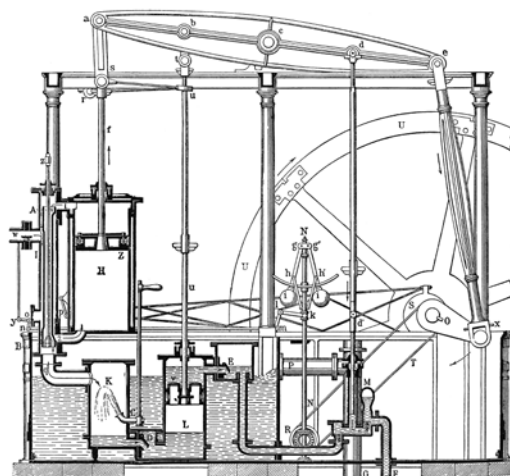

Diagram of James Watt's Steam Engine. From: A. Guillemin, *La vapeur*, Paris (1876).

disciplines. The Anthropocene Project brings together thinkers from all fields in a collaborative effort to explore not just questions about the Anthropocene theory itself, but also questions about how we can integrate the disciplinary perspectives and working practices of artists, humanists, and scientists.

Yvonne Wübben (Visiting Scholar, Universität Bochum, Germany)

Writing the Textbook Case: Epistemic Genre and Practices in Psychiatry (1870–1920)

Up to the present day, clinical teaching has not been the most important means of transmitting psychiatric knowledge. Rather, professional training is mainly conveyed and shaped through textbooks. Students and teachers read and reread books in order to gain or dispute insights within a vast and complex medical field. This project investigates the culture of the psychiatric textbook as a crucial aspect in the formation of the discipline. It reconstructs the writing, reading, and teaching practices by focusing on the rhetoric of the book, its strategies of visualization, narrations, and typographic codes, especially in the late nineteenth and early twentieth centuries, when psychiatry entered its phase of professionalization.



Yvonne Wübben

Hansjakob Ziemer (Research Scholar, MPIWG)

Translating Everyday Experience into Social Knowledge: Central European Feuilleton Culture Around 1900

The aim of this project is to show how the history of the feuilleton must be located within a cultural history of knowledge production; it takes as its starting point a group of journalists in German-speaking Central Europe, from the 1890s onwards, who developed novel reporting styles and who devoted themselves to the observation of the social world. The feuilleton is of interest as a formal venue for discussing and processing social and cultural information; it provided methods and tools that allowed readers to form judgments and make sense of contemporary social and cultural issues before this knowledge was transferred into disciplinary social science. How did feuilleton writers move from the ephemeral details of everyday life to larger claims of social truth that were then received as forms of social knowledge? To what extent did feuilleton writers anticipate, and perhaps even contribute to, the emergence of the academic disciplines of sociology and contemporary history?



Hansjakob Ziemer



Subway riders reading the Sunday Dispatch (1935). Photo: Erich Salomon, Berlinische Galerie, Berlin.

Between the Natural and the Human Sciences

Short-Term Visiting Scholars

Francesca Bordogna (Northwestern University, USA), *Karine Chemla* (Université Paris 7, France), *John Christie* (University of Oxford, UK), *Kasper Risbjerg Eskildsen* (Roskilde Universitet, Denmark), *Marie Farge* (Ecole Normale Supérieure, Paris, France), *Michael Friedman* (Stanford University, USA), *Stefanos Geroulanos* (New York University, USA), *Orit Halpern* (New School for Social Research, New York, USA), *Felix Hasler* (Universität Zürich, Switzerland), *Theresa Kelley* (University of Wisconsin, Madison, USA), *Pamela Kort* (Universität Zürich, Switzerland), *Angela Matyssek* (Universität Marburg, Germany), *Harro Maas* (Universiteit van Amsterdam, The Netherlands), *Andrew Mendelsohn* (King's College, UC London, UK), *Erika Lorraine Milam* (Princeton University, USA), *Caitlin Murdock* (California State University – Long Beach, USA), *Elizabeth Neswald* (Brock University, Canada), *Laura Otis* (Emory University, USA), *Gregory Radick* (University of Leeds, UK), *Andrew Reynolds* (Cape Greton University, Canada), *Harriet Ritvo* (Massachusetts Institute of Technology, USA), *Neil F. Safier* (University of British Columbia, Canada), *Wolfgang Schivelbusch* (New York, USA/Berlin, Germany), *John Tresch* (University of Pennsylvania, USA) *M. Norton Wise* (University of California, Los Angeles, USA)

Project

Gender Studies of Science

ORGANIZERS *Christine von Oertzen* (MPIWG), *Annette Vogt* (MPIWG)

Research on the history of women and gender in science, technology, and medicine has expanded considerably in recent years. The diversity and creativity of approaches in this field encourage Department II to support individual projects employing the category of gender to historicize the production of scientific knowledge. Our particular interest is the creation of knowledge beyond those realms traditionally associated with scientific endeavor, beyond laboratories, universities, and state-sponsored research institutes.

Working Group

Beyond the Academy: Histories of Gender and Knowledge

June 18–19, 2010 and July 7–9, 2011

ORGANIZERS *Christine von Oertzen* (MPIWG), *Maria Rentetzi* (Technical University of Athens, Greece), *Elizabeth Watkins* (University of California, San Francisco, USA)

The focus of this Working Group was science pursued in contexts other than accredited institutions, state-sponsored universities, and research institutes — in locations such as the kitchen, the nursery, and the storefront. Divisions between authorized and popularized science were status-laden in different times and places, even if the scientific practices (e.g., observation of infant language acquisition) were similar. When attention is paid to gender and geographies, and when hierarchies of knowledge production are rejected, what emerges is a colorful landscape of communities and individuals producing science and pursuing scholarship, evoking a knowledge society *avant la lettre* that inspires new, broader definitions of science and scientist. Six of the essays discussed at the two Working Group meetings will appear in the July 2013 issue of *Centaurus*.

Margaret Best Putnam, a rural physician's wife, at her microscope, 1930s. Putnam Family Archive, Concord, USA. Courtesy Constance E. Putnam.



Table of Contents

- Christine von Oertzen, Maria Rentetzi, Elizabeth Watkins, *Introduction – Finding Science in Surprising Places: Gender and the Geography of Knowledge Production*
- Elaine Leong, *Collecting Knowledge for the Family: Recipes, Gender, and Practical Knowledge in the Early Modern English Household*
- Carla Bittel, *Woman, Know Thyself: Producing and Using Phrenological Knowledge in Nineteenth-Century America*
- Christine von Oertzen, *Science in the Cradle: Milicent Shinn and Her Home-Based Network of Baby Observers, 1890–1910*
- Kirsten Leng, *Defining an “Elusive” Phenomenon: Sexual Science, German Feminism, and the Female Sex Drive at the Turn of the Twentieth Century*
- Sally Gregory Kohlstedt, *Innovative Niche Scientists: Women’s Role in Reframing North American Museums, 1880–1930*
- Gianna Pomata, *Amateurs by Choice: Women and the Pursuit of Independent Scholarship in Twentieth-Century Historical Writing*



Members of the Working Group, July 2011.
From left to right: Constance Putnam, Sally G. Kohlstedt, Elaine Leong, Liesbeth Hesselink, Kirsten Leng, Christine von Oertzen, Poly Giannakopoulou, Maria Rentetzi, Mineke Bosch, Carla Bittel, Elizabeth Watkins.

Gender Studies of Science

Individual Projects

Christine von Oertzen (Research Scholar, MPIWG)

At-Home Observation of Early Childhood Development in Gilded Age America

This project illustrates how members of the Association of Collegiate Alumnae (ACA), most prominent among them Milicent Shinn, a graduate of the University of California, engaged in the study of early childhood development. Their efforts culminated in an unprecedented network of at-home scientific observation of infants that



spanned the North American continent. Shinn and her female peers were inspired by contemporary scholarly enthusiasm for the physiological and mental development of infants and toddlers. During the last decades of the nineteenth century, men of science discovered in their own and others' offspring, to borrow Charles Darwin's phrase, "objects of natural history." On the basis of the unpublished papers of Milicent Shinn and the correspondence of other members of her network, this project reveals how the ACA's collective at-home observation of babies transformed the nursery into a laboratory and mothers into scientific observers.



Christine von Oertzen

Milicent Shinn with her object of study, Ruth, at the age of seven. From: M. Shinn, *Körperliche und geistige Entwicklung eines Kindes in biografischer Darstellung*, Langensalza (1905).

Elena Serrano (Postdoctoral Fellow, MPIWG)

Science for Women in the Spanish Country House (1780–1808)

This investigation of late eighteenth-century Spanish economic agriculture, a broadly defined science that encompassed agricultural knowledge, botany, chemistry, healing practices, domestic economy, artisan skills, and rural architecture, explores how women shaped its practice, values, and public image. Major sources include books on economic agriculture and the architecture of some aristocratic country houses. The hybrid Madrid aristocratic country houses, halfway between the public and the private, were built at the capital's outskirts. One of these was El Capricho ("The Whim"), owned by the Duquesa de Osuna (1750–1834), the director of an outstanding female economic society, the Junta de damas. Along with grottos and Goya's frescoes, she built an elegant glass beehive and promoted agricultural experiments. The aim is to extend recent scholarship that analyzes how ideas about feminine nature influenced women's actions in the Spanish public sphere, especially in science.

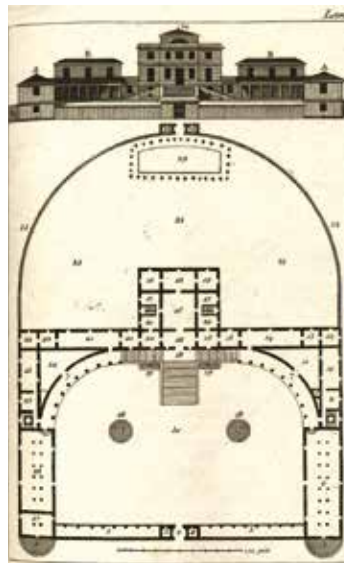

Elena Serrano

„La casa de labor“, in: *Semanario de agricultura y artes dirigido a los párrocos*, IV (1798).



Dora Vargha

Dora Vargha (Predoctoral Fellow, Rutgers University, USA)

Iron Curtain, Iron Lungs: Polio Epidemics in Cold War Hungary 1952–1963

This dissertation studies the politics of polio epidemics in Hungary as they reflect on international public health policies, professional and familial roles, and concepts of bodily production. The project cuts across disciplines, entwining the fields of gender history, history of medicine, childhood and disability studies, and the history of international relations. By exploring an Eastern European history of polio with a broad geographical perspective, the dissertation contributes to the sporadic history of the disease in Europe, and to a mostly unexplored history of health and medicine in Eastern Europe.

Child receiving Sabin vaccine in Budapest. *Népszava*, December 15 (1959). Photograph by György Gonda.



Annette Vogt

Annette Vogt (Research Scholar, MPIWG)

At the Front Door? Women Scientists at the Humboldt University, 1946–1961

This project investigates the conditions faced by female scientists at the Humboldt University in Berlin from its reopening in 1946 to 1961. One of the questions examined is whether the situation for women scientists improved following the major setbacks experienced by women during the Nazi regime. In 1946, only six women scientists became professors (out of three hundred male professors). They belonged to three (of ten) faculties, among them the geneticist Elisabeth Schiemann and the philosopher Liselotte Richter. Between 1948 and 1951, five of the six female professors left the university because of political circumstances; Physicist Katharina Boll-Dornberger, born Schiff, belonged to the small group of remigrées who returned from exile after 1945. She was appointed professor in 1956. Many discussions and problems from that era remain current in our own time — such as the debates about women’s role in science and society, the controversy about scientific work versus motherhood, and the question of couples in science.



Katharina Boll-Dornberger. Archive of the Berlin Brandenburg Academy of Science, Berlin.

Kathleen Vongsathorn (Postdoctoral Fellow, MPIWG)

Women and the Spread of Biomedical Knowledge in Colonial Uganda, 1897–1962

Although women rarely appear in the formal medical reports generated by Uganda's colonial doctors, women trained in biomedicine have outnumbered men with such training in Uganda's mission medical institutions. Many of these women have carried primary responsibility for the maintenance of medical institutions and the biomedical education of Ugandans. Drawing on mission and hospital archives in Europe and Uganda, this project focuses on several types of biomedical education, each of which was primarily the province of European and Ugandan women: maternal and child health, general health and hygiene, and leprosy treatment and prevention. Much of the institutionalized teaching of biomedicine in Uganda was in the hands of women missionaries, for instance in the nursing and midwifery training schools that they founded and operated, and in the teaching of hygiene and preventive health measures within mission schools. Less formally, missionary women taught Ugandans about preventive and curative health within general hospitals, dispensaries, and leprosy settlements, and on outreach "medical safaris." In turn, the Ugandan women that the missionaries trained as nurses and midwives were tasked with spreading biomedical knowledge, especially as related to the health of mothers and children.

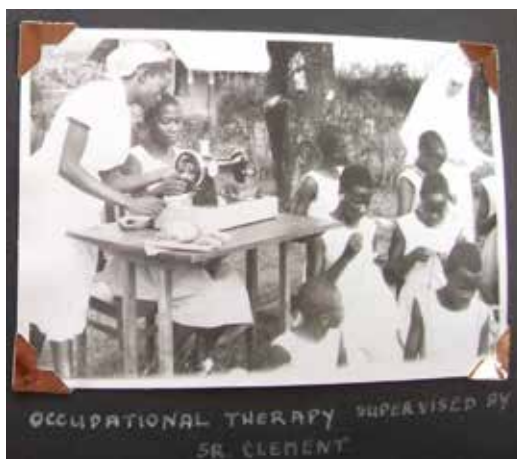

Kathleen Vongsathorn

Photo Album, Nyenga Leprosy Settlement (early 1960s). Franciscan Missionary Sisters for Africa Convent, Dundalk, Ireland.

Gender Studies of Science

Short-Term Visiting Scholars

Vanessa Agnew (University of Michigan, USA), *Mineke Bosch* (University of Groningen, The Netherlands), *Kirsten Leng* (Northwestern University, USA), *Anne Overbeck* (Universität Münster, Germany), *Martina Schlünder* (MPIWG/Universität Göttingen, Germany)

Project

Science in Circulation: The Exchange of Knowledge Across Cultures, 9th–18th Centuries

ORGANIZERS *Lorraine Daston* (MPIWG), *Rivka Feldhay* (University of Tel Aviv, Israel), *Jamil Ragep* (McGill University, Canada), *Sally P. Ragep* (McGill University, Canada), *Pamela H. Smith* (Columbia University, USA)

Commodities, ideas, facts, instruments, texts, techniques, and people all travel — but selectively. Knowledge, both implicit and explicit, does not spread simply because it is true or useful; nor do the paths it takes cover the globe. The “Science in Circulation” project focuses on which knowledge circulates and where, how, and with whom it does so. Although the questions posed by the project potentially apply to many epochs and cultures, the project concentrates on the period from the fifteenth to the eighteenth century and the geographical areas of the Mediterranean basin, the Atlantic, and Central Asia because the opening up of new trade routes and markets, religious migrations, and advances in navigation, military, and colonial initiatives all conspired to set an unprecedented number of things, people, and thoughts in motion. The Working Groups devoted to this research project combine the perspectives of the history of science and technology with those of social and economic history and the geography of knowledge.



Jan van Kessel & Erasmus Quellinus, *Asien* (ca. 1664/66), detail. Alte Pinakothek, Munich, Germany.

Three Working Groups in Department II address this topic: “Before Copernicus” (organized by Rivka Feldhay, University of Tel Aviv, Israel, and Jamil Ragep, McGill University, Canada; to be completed in 2013), “Testing Drugs and Trying Cures in the Early Modern World” (organized by Elaine Leong, MPIWG; to begin in 2014), and “Itineraries of Materials, Recipes, Techniques, and Knowledge in the Early Modern World” (organized by Pamela H. Smith, Columbia University, USA; to begin in 2014).

ISMI: Islamic Scientific Manuscripts Initiative

ORGANIZERS *Jamil Ragep* (McGill University, Canada), *Sally P. Ragep* (McGill University, Canada), *Urs Schoepflin* (MPIWG), *Dirk Wintergrün* (MPIWG)

COOPERATION PARTNERS Institute of Islamic Studies at McGill University (Canada), Staatsbibliothek Berlin (Germany)

Other sponsors include the American Council on Learned Societies; Canada Foundation for Innovation; and Gouvernement du Québec.

Member Institutions of the ISMI Board: Institute for the Study of Muslim Civilizations, Aga Khan University, London, UK; Archimedes Project, Harvard University, USA; Filologia Semítica, Universitat de Barcelona, Spain ; Encyclopaedia Islamica Foundation, Tehran, Iran; Institute for the History of Arabic Science, Aleppo University, Syria; Institute for the History of Science and Technology, Moscow, Russia; Institute of Ismaili Studies, London, UK; Warburg Institute, London, UK; The Written Heritage Research Center, Tehran, Iran

ISMI is a component of the Rational Sciences in Islam (RaSI) project centered at McGill University, which includes an object-relational database created to store information on the rational sciences within the scientific, philosophical, and theological traditions of Islam before 1900 CE. ISMI catalogs basic metadata and content data of all manuscripts in the exact sciences in Islamic (astronomy, mathematics, physics, geography, mechanics, and related disciplines). Through the Internet, this material will be accessible without charge both to researchers and experts in the field and to the educated public worldwide. This online database will contain the works of some 2,126 people (authors, annotators, copyists, correctors, dedicatees, illuminators, illustrators, inspectors, owners, patrons, students, readers, teachers, translators) who span the entire Islamic world from Islamic Spain to India and the borders of China, beginning in the eighth century and continuing until the nineteenth. To date, images of



Title page of *Al-TabS.ira fi 'ilm al-h.isāb* (*Insight into the Science of Arithmetic*) by Ibn Yahyā al-Maghribī, Ahlwardt 5962, Staatsbibliothek Berlin. Open access via ISMI.

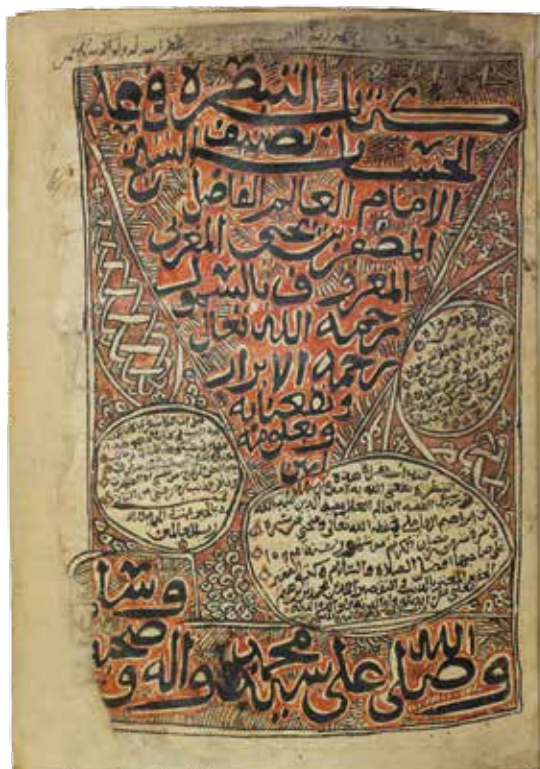

roughly 3,400 codices from throughout the world (from repositories that include Turkey, Iran, Europe, the Middle East, and North America) have been collected and are ready to be linked to the database with information on 3,741 titles and 12,901 witnesses to these titles.

Science in Circulation

Conference

Instructions, Questions, and Directions

September 21–22, 2012

ORGANIZER *Daniel Carey* (National University of Ireland, Galway, Ireland)

COOPERATION PARTNER National University of Ireland (Galway, Ireland)

Funded by the Andrew W. Mellon Foundation

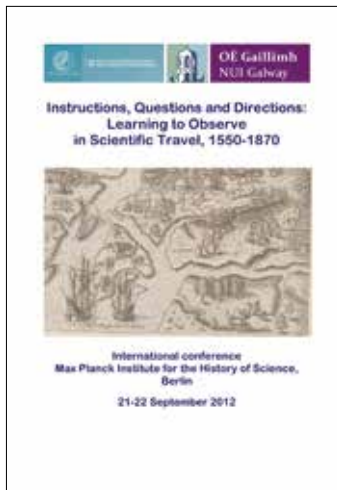

The proliferation of inquiries, questionnaires, and directions for scientific travelers is a defining feature of the early modern period, ranging from Humanist agendas for Continental journeys to formal initiatives by Spanish authorities concerned with colonial administration. Exceptional growth in this practice occurred in a variety of seventeenth-, eighteenth-, and nineteenth-century contexts. This conference explored the traditions and preoccupations behind this activity in a series of different locations.

Participants

- *Daniel Carey* (NUI Galway, Ireland)
- *Dominik Collet* (Universität Göttingen, Germany)
- *Edward Collins* (University of Seville, Spain)
- *Martha Fleming* (Natural History Museum, London, UK)
- *Gabor Gelleri* (NUI Galway, Ireland)
- *Pierre-Yves Lacour* (C.R.I.S.E.S., Université Paul Valéry 3, Montpellier, France)
- *Daniel Margocsy* (Hunter College, CUNY, USA)
- *Paola Molino* (Universität Wien, Austria)
- *Staffan Müller-Wille* (University of Exeter, UK)
- *Eavan O'Dochartaigh* (NUI Galway, Ireland)
- *Juan Pimentel* (CCHS, Madrid, Spain)
- *Maria Portuondo* (Johns Hopkins University, USA)
- *Ida Pugliese* (European University Institute, Florence, Italy)
- *Neil Safier* (University of British Columbia, Canada)
- *Carl Thompson* (Nottingham Trent University, UK)
- *Sven Trakulhun* (Universität Zürich, Switzerland)
- *Paul White* (University of Cambridge, UK)

Science in Circulation

Individual Projects

Harun Küçük (Predoctoral Fellow, University of California, San Diego, USA)

Early Enlightenment in Istanbul

A persistent theme in European scholarship is how Enlightenment thinkers approached Islam; but no one has yet asked if and how Muslims engaged with Enlightenment thought. This dissertation shows that under the reign of Ahmed III (1703–1730), Ottoman naturalists joined the Sultan in forging a new religious, political, and philosophical order that was in line with Enlightenment ideas and ideals; it also argues that the Ottoman court was an indispensable element in both the Neo-Hellenic Enlightenment and the autochthonous Islamic enlightenment of the eighteenth century. Topics covered include how the University of Padua's naturalistic interpretation of Aristotle came to replace Islamic Avicennism; how Ottoman physicians reacted against Galenic medical orthodoxy and the strictures that Islam placed on their discipline, and how some of them went so far in their reactions as to deny the immortality of the soul; how sociability helped Ottoman thinkers valorize experimentation as a reliable method for creating new knowledge; how philosophy became an indispensable part of the statesman's education; how the first Ottoman printing press, founded in 1729, represented the ideal that learning should be universally accessible and promoted the idea that the dissemination of knowledge was integral to a sound social order; and how, finally, Parisian Cartesianism threatened to supplant Ottoman scholasticism — all within the space of some thirty years.



Harun Küçük

Katharine Park (Visiting Scholar, Harvard University, USA)

Knowledge on the Move: Scientific Encounters in the Muslim and Christian Worlds, 500–1500

This project will yield a short textbook, suitable for teaching the history of medieval science in university-level courses. The book, which is based on a course cotaught with Ahmed Ragab in the History of Science Department at Harvard, will present science in Latin Europe and the Arabic Middle East/North Africa/Iberia as a unified phenomenon with a unified history, rather than as part of a story describing the transfer of knowledge from Greek antiquity to early modern Europe.



Katharine Park

Completed Project

History of Scientific Observation

DURATION 2005–2010

ORGANIZERS *Lorraine Daston* (MPIWG), *Andreas Mayer* (MPIWG),
Tania Munz (MPIWG), *Thomas Sturm* (MPIWG), *Kelley Wilder* (MPIWG)

COOPERATION PARTNERS Freie Universität Berlin (Germany); Universiteit van Amsterdam (The Netherlands); additional external funding of individual scholars

Observation is the most pervasive and fundamental practice of all of the modern sciences, both natural and human. It is also among the most refined and variegated of these practices. Observation educates the senses, calibrates judgment, picks out objects of scientific inquiry, and forges communities. Its instruments include not only the naked senses, but also tools such as the telescope and microscope, the questionnaire, the photographic plate, the glassed-in beehive, the Geiger counter, and a myriad of other ingenious inventions designed to make the invisible visible, the evanescent permanent, the abstract concrete. Where is society? How blue is the sky? Which way do X-rays scatter? Over the course of centuries, scientific observers have devised ways to answer these and many other riddles — and thereby redefined what is under investigation by the way in which it is investigated. Observation discovers the world anew.

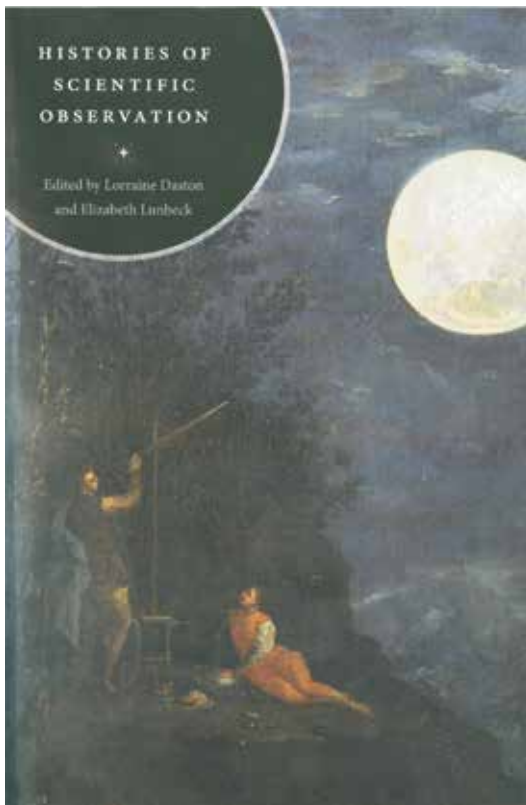

At the core of this project was a Working Group, which resulted in the volume *Histories of Scientific Observation*, edited by Lorraine Daston and Elizabeth Lunbeck (University of Chicago Press, 2011). The book features engaging episodes drawn from a wide variety of sciences, ranging from meteorology, medicine, and natural history to economics, astronomy, and psychology. The contributions spotlight how observers have scrutinized everything — from seaweed to X-ray radiation, household budgets to the emotions — with ingenuity, curiosity, and perseverance verging on obsession. In addition, 37 junior and senior scholars with individual projects on the history of observation took part in this project.

MPG Minerva Research Group

Constructions of the Brain: The Emergence of the Neurological Adolescent

DURATION 2008–2012

ORGANIZER *Suparna Choudhury* (MPIWG/MPG Minerva Program; as of September 2012, Assistant Professor, McGill University, Montreal, Canada)

COOPERATION PARTNERS Institute for Mind and Brain, Humboldt-Universität zu Berlin (Germany); McGill University (Canada)



Suparna Choudhury

The goal of this project was to develop meaningful interactions between history of science, anthropology, and cognitive neuroscience. Using the framework of Critical Neuroscience (www.critical-neuroscience.org) and intersecting with the “Cerebral Subject” project, “Constructions of the Brain” sought to examine the cultural contexts and social functions of recent research in the neurosciences, including questions about the social brain, cultural differences, and cognitive development. A particular focus of the project was the adolescent brain. The adolescence project studied how ideas and practices related to mental and moral development during adolescence developed from the late nineteenth century to current frameworks in neuroscience and psychiatry. It also explored the ways in which brain-based explanations of adolescence are appropriated in clinical, educational, and popular domains, and among adolescents themselves, in diverse cultural contexts.

L. Ebensperger, *Storm and Stress in the Adolescent Brain* (2009).



Conference

Neuro-Reality Check: Scrutinizing the “Neuro-Turn” in the Humanities and Natural Sciences

December 1–2, 2011

ORGANIZERS *Suparna Choudhury* (MPIWG), *Max Stadler* (ETH Zürich, Switzerland)

Few developments in the world of science and technology today generate comparable degrees of attention, commentary, and sheer excitement than the neurosciences. Within and beyond academia it has become routine to celebrate or, alternatively, to castigate the purportedly palpable effects and consequences — social, political, cultural, and intellectual — of the recent expansion of the neurosciences. Whether we witness art historians finding fault with neuro-enthusiastic colleagues, linguists warning of a “new biologism,” ethicists, science policy strategists, and anthropologists pondering the future impact of neuroscience, literary critics and artists dabbling



Human Engine built by schoolboys.
From: *Popular Science* (April 1929)

in mirror neurons, or media-savvy neuroscientists forming a new kind of public intellectual, the neurosciences have, without question, inspired a great deal of scholarly and not-so-scholarly action. Indeed, these discourses have become so familiar, their significance so seemingly self-evident, that critical positions on the neurosciences rarely appear to move beyond elaborations of the already familiar or partisan polemics. The workshop “Neuro-Reality Check” brought together scholars from a wide range of disciplinary backgrounds with the aim of stepping back a little — and of probing deeper into the alleged effects and actual causes of the ongoing neurohype. A book entitled *Neuro-Reality Check: Scrutinizing the “Neuro-Turn” in the Humanities* will be published in 2014.

Participants

- *Nima Bassiri* (Duke University, USA)
- *Felicity Callard* (MPIWG/University of Durham, UK)
- *Stephen Casper* (Clarkson University, New York, USA)
- *Roger Cooter* (University College London, UK)
- *Steven Fuller* (University of Warwick, UK)
- *Sky Gross* (Tel Aviv University, Israel)
- *Jenell Johnson* (University of Wisconsin-Madison, USA)
- *Melissa Littlefield* (University of Illinois, USA)
- *Daniel Margulies* (MPIKN, Leipzig, Germany)
- *Constantina Papoulias* (Middlesex University London, UK)
- *Martyn Pickersgill* (University of Edinburgh, UK)
- *Amir Raz* (McGill University, Canada)
- *Julia Voss* (Frankfurter Allgemeine Zeitung, Frankfurt, Germany)
- *Simon Williams* (University of Warwick, UK)
- *Allan Young* (McGill University, Canada)

Constructions of the Brain

Individual Project



Felicity Callard

Felicity Callard (Postdoctoral Fellow, MPIWG; as of February 2012 lecturer, Durham University, UK)

The Adolescent Daydreamer: Experimental Investigations of Inner Experience from Late-Nineteenth-Century Psychology to Twenty-First-Century Cognitive Neuroscience

Stanley Hall, in his famous 1904 monograph on adolescence, argued that “inner absorption and reverie is one marked characteristic of this age of transition.” “The Adolescent Daydreamer” project is investigating how the adolescent has been configured as a daydreamer through the scientific study of her mental states. It explores how psychologists, psychoanalysts, and cognitive neuroscientists have used experimental techniques in their attempts to define and acquire data about daydreaming. These investigations have contributed to consolidating different models of adolescence, most notably by establishing normative expectations vis-à-vis the developing human subject’s engagements with her internal mental world.

MPG Minerva Research Group

Reading and Writing Nature in Early Modern Europe

DURATION 2012–2017

RESEARCH GROUP LEADER *Elaine Leong* (MPIWG/MPG Minerva Program)

Since the introduction of Gutenberg's invention of movable type, medical and scientific ideas have circulated in printed books, journals, and pamphlets. Medical print not only allowed academics and medical "professionals" to exchange and discuss new knowledge, but opened access to health-related information for patients and their families. As readers, early modern men and women devoured all sorts of medical texts, from hefty learned tomes to broadsheets advertising wondrous cures, leaving traces of their encounters in book margins, battered leather-bound notebooks, and in the flurry of letters sent between friends, families, and acquaintances. These reading "notes" are rarely straightforward copies of existing texts but rather records of particular readers' appropriation of natural knowledge through processes of information selection, organization, and modification. Within these same pages, our readers also recorded their own first-hand experiences with healing and preserving the human body, their experimentation with drugs and cures, and their observations on nature. Thus, as they put pen to paper, their acts of reading became acts of writing; what might at first sight seem to be an act of knowledge transmission becomes an act of knowledge production. This research group investigates how reading and writing practices shaped the codification of medical and natural knowledge in early modern Europe.

A three-year position for a postdoctoral fellow will be filled in September 2013.

Jan van Belkamp (attr.), *The Great Picture* (1646), detail. Content and composition were determined by Lady Anne Clifford. Abbot Hall Art Gallery, Kendal, UK.



Reading and Writing Nature Individual Project



Elaine Leong

Elaine Leong (MPIWG/MPG Minerva Program)

Treasuries for Health: Medical Knowledge and Practices in the Early Modern Household

This book project traces home-based medical and scientific activities in seventeenth-century England through in-depth studies of manuscript and printed medical recipe collections. Hundreds of early modern recipe books containing a mixture of medical,

culinary, and household information survive in modern archives. The sheer number of examples attests both to the early modern fascination with short tidbits of instruction and to the crucial role played by these texts in the circulation of practical knowledge. These notebooks of various sizes and qualities were regarded as objects of value by contemporaries and often appear in inventories and wills. However, with their dense listing of recipe after recipe with little or no theoretical explanation, many of these books remain a puzzle to modern historians and literary scholars. Why were early modern men and



Page of recipes from Lady Ann Fanshawe's book in various hands, with a sketch of a chocolate pot affixed (mid-seventeenth century). Image courtesy of Wellcome Library, London.

women so intrigued by and enthusiastic about recipes? What role did these texts play in the production of vernacular natural knowledge? What sorts of medical activities were conducted within kitchens, closets, and stillrooms? How do recipes and practical knowledge fit into wider frameworks of natural inquiry? In what ways do home-based medical practices connect and relate to commercially available health services? Based on extensive archival research, this project is the first study to locate and contextualize household recipes within narratives of early modern knowledge codification and transfer, medical and scientific practices, and manuscript and print cultures.

Reading and Writing Nature in Early Modern Europe Planned Working Group

Testing Drugs and Trying Cures in the Early Modern World

(to begin in 2014)

See description on the MPIWG website: http://www.mpiwg-berlin.mpg.de/en/research/projects/DeptII_Leong_TestingDrugs/index_html.

Dilthey Fellowship Research Group, Volkswagen Foundation

The Making of Acoustics in 16th–to 19th-Century Europe

DURATION 2011–2016

RESEARCH GROUP LEADER Viktoria Tkaczyk (MPIWG/Universiteit van Amsterdam, The Netherlands)

The sixteenth to the nineteenth century represents a period that corresponds to a series of fundamental findings in acoustics. The aim of this project is to show, however, that the history of acoustics is not limited to the emergence of an exact science, but must also be located in a history of religious, cultural, and artistic practices. The “acoustic” is therefore of interest in its dual function as producer and object of science/knowledge.

Individual Projects

Viktoria Tkaczyk (MPIWG/Universiteit van Amsterdam, The Netherlands)

Spoken Word Theatre and the Architects of Sound, 1750–1930

This project explores the links between the history of European spoken word theater and acoustics from 1750 to 1930, when acoustics gradually became established as an academic discipline and was differentiated into different subdisciplines (the physiology of speaking and hearing, architectural acoustics, electroacoustics, sound engineering, etc.). Starting from the observation that spoken word theater praxis simultaneously creates new educational aspirations and thus seeks out new speaking techniques and ways of organizing space acoustically, this study investigates whether theater theory and practice anticipated specific insights of acoustics. Thematically, the project is divided into three focus areas: (a) Speaking, Hearing, and Auditory Memory; (b) Architectural Acoustics; and (c) Sound Media and Sound Archives.



Viktoria Tkaczyk

Advertising poster by Jules Chéret (1896).
Litograph from the series *Les Maîtres de
L'Affiches*, Imprimerie Chaix, Paris.



Anna Kvičalová

Anna Kvičalová (Predoctoral Fellow, Universiteit van Amsterdam, The Netherlands)
Listening Techniques in Post-Reformation Geneva: Evidence from the Registers of the Consistory (1542–1555)

This project investigates new modes of preaching, listening, and remembering as they appear in mid-sixteenth-century Geneva in the context of religious reform, against the background of a cultural history of hearing and the gradual emergence of acoustics as a scientific discipline. The consistory of Geneva—its church discipline and policy—will be studied alongside a more general “acoustic turn” in the Calvinist period. Spectatorial means of communication were rejected in favor of verbal instruction in the vernacular, which became the primary means for communicating religious knowledge to the population.

The Making of Acoustics

Research Network

Hearing Knowledge in Transition (2012–2015, funded by the Deutsche Forschungsgemeinschaft)

This network of scholars explores transitions in our understanding of hearing, an integral if often overlooked sensory dimension of modernity, and seeks to historicize key concepts and assumptions of sound across different cultures.

Network Members

- *Camilla Bork* (Humboldt-Universität zu Berlin, Germany)
- *Mary Helen Dupree* (Georgetown University, USA)
- *Nicola Gess* (Universität Basel, Switzerland)
- *Angela Grunberg* (University of Sheffield, UK)
- *Alexandra Hui* (Mississippi State University, USA)
- *Julia Kursell* (Universiteit van Amsterdam, The Netherlands)
- *Britta Lange* (Humboldt-Universität zu Berlin, Germany)
- *Jan-Friedrich Missfelder* (Universität Zürich, Switzerland)
- *Daniel Morat* (Freie Universität Berlin, Germany)
- *Manuela Schwartz* (Hochschule Magdeburg/Stendal, Germany)
- *Viktoria Tkaczyk* (MPIWG/Universiteit van Amsterdam, The Netherlands)
- *Axel Volmar* (Universität Siegen, Germany)
- *Caroline Welsh* (Universität Erlangen-Nürnberg, Germany)
- *Rebecca Wolf* (Harvard University, USA)
- *Hansjakob Ziemer* (MPIWG)

Pre- and Postdoctoral Fellows

During the reporting period 2010–2012, Department II hosted over forty pre- and postdoctoral fellows from twenty countries for periods ranging from one month to three years, with both MPIWG and external funding. The research of longer-term, MPIWG-financed pre- and postdocs is described above under the relevant project; dissertations completed entirely under the auspices of Department II are described below. For ready reference, a list of additional pre- and postdoctoral fellows resident in Department II for shorter periods is provided here; for further details, please see the Appendix.

→ p. 229

Completed Dissertations

Nils Güttler (Predoctoral Fellow, Humboldt-Universität zu Berlin, Germany; as of September 2012, Forschungszentrum Gotha, Germany)

The Cosmoscope and Its Users: The Role of Maps in 19th-Century Plant Geography

This dissertation tracked the history of a particular practice among plant geographers: mapmaking. It reconstructed the history of botanical distribution maps from a practical point of view: as media-in-use. The medium was invented in the late eighteenth century by Alexander von Humboldt and others, yet it took decades until botanists, initially in Central Europe, generally began to use maps as research tools. Graphical reasoning then became an integral part of discourses on the geography of plants. This mapping impulse, however, did not come from professional groups within the botanical community. The routine production of botanical distribution maps originated in institutions that are customarily placed at the academic periphery: cartographical publishing companies and regional societies of natural history. Apart from their epistemic potential, these maps had a powerful social and economic dimension as well.



Nils Güttler

Johann Bernhard Wilbrand, *Gemälde der organischen Natur in ihrer Verbreitung auf der Erde*, 1810, detail. Courtesy Leiden University Library.





Stefanie Klamm

Stefanie Klamm (Predoctoral Fellow, Humboldt-Universität zu Berlin, Germany/ Bauhaus-Universität Weimar, Germany; as of November 2012, assistant curator at the Staatliche Museen zu Berlin, Germany)

Images of the Past: Strategies of Archaeological Visualisation in the 19th Century

In the mid-nineteenth century, when archaeology began to emerge as an academic discipline its practitioners experimented with the then-new photographic technology. However, other instruments of replication and reproduction were both proven and available at the same time; drawings, prints, and plaster casts were used up to the twentieth century. This dissertation analyzed the consequences of this plurality of media for the formation of knowledge in classical archaeology, focusing on excavation. Starting from the German excavations in Olympia, Greece, from 1875 to 1881, and taking into account further examples of archaeological excavations as case studies, the dissertation investigated archival sources such as diaries and notebooks as well as published material such as articles, manuals, compendia of images, excavation reports and drawings, and photographs and their printed forms (as well as the graphically reproduced cast). The dissertation showed that both visual conventions from different areas of knowledge as well as the encounter with the excavation field affected the creation of an archaeological imagery.

View of excavation site in Olympia from east, in: Ernst Curtius, Friedrich Adler, Gustav Hirschfeld (eds.), *Die Ausgrabungen zu Olympia I. Übersicht der Arbeiten und Funde vom Winter und Frühjahr 1875-1876*, Berlin (1876).

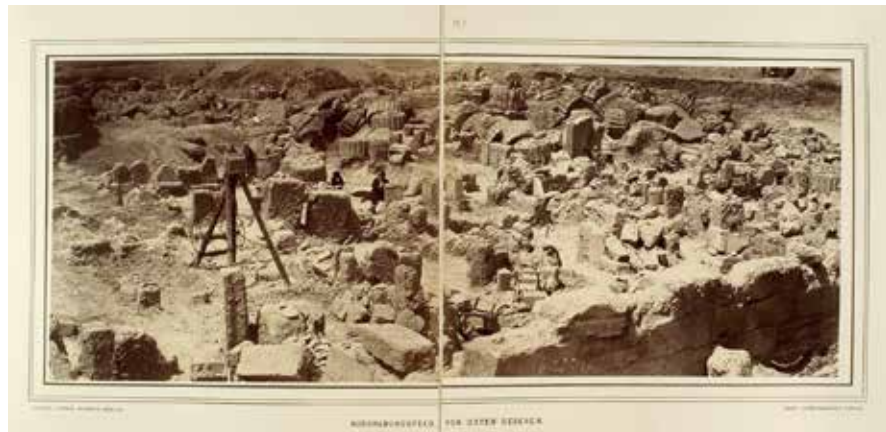

Fabian Krämer

Fabian Krämer (Predoctoral Fellow, Universität München, Germany; as of September 2012, Assistant Professor/wissenschaftlicher Rat, Universität München, Germany)

How Did a Centaur Get to Early Modern London? Observation and Reading in the European Study of Nature, ca. 1550-1750

Building on Gianna Pomata and Nancy G. Siraisi's notion of "learned empiricism," this dissertation aimed at overcoming the dichotomy between early modern erudition and enlightened empiricism. In order to do so, it concentrated on the early modern naturalist discourse on monsters and tackled the following questions: Whence did European naturalists in the seventeenth century get their knowledge on this subject matter? Which knowledge sources did they privilege and consider especially authoritative, book learning or empirical observation — if indeed they were opposed?

Distinctly early modern types of empiricism with strong learned components lie at the heart of my explanation of the presence of reports and visualizations of phenomena (many incredible to the modern reader) in the works of early modern European authors.

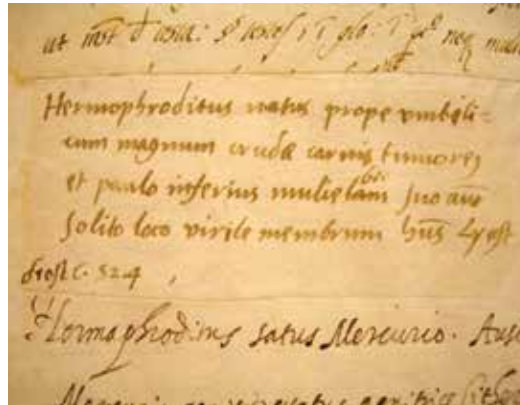

Manuscript note in Ulisse Aldrovandi's commonplace book on an hermaphrodite born in Zurich in 1519; quotation from Conrad Lycosthenes, *Prodigiorum ac ostentorum chronicon etc.*, Basel (1557), p.524.

Pre- and Postdoctoral Fellows Hosted by Department II

Daniel Andersson, Elisa Andretta, Noam Andrews, Vesa Arponen, Monica Aufrecht, Naomi Beck, Estelle Blaschke, Katherine Sara Boyce-Jacino, S. Pearl Brilmyer, Sophia Danielle Davis, Guillermo de Eugenio Pérez, Nike Verena Fakiner, Aude Fauvel, Andrew M. Fearnley, Yulia Frumer, Isabel Gabel, Carmine Grimaldi, Jean-Baptiste Gouyon, Jacob K. Habinek, Daniela Helbig, Catherine Herfeld, Leyla Mariane Joaquim, Ryan Amir Kashanipour, Joel Klein, Jana Klenhova, Ulla Kypta, Pierre-Yves Lacour, Lucie Laplane, Adam Lawrence, William Lockhart, Oana Mateescu, Francis McKay, Teru Miyake, Anindita Nag, Omar W. Nasim, Zoe Nyssa, Anne Overbeck, Harriet Palfreyman, Marissa Helene Petrou, Christopher Plumb, Brigit Ramsingh, Christoph Rosol, Eric Savoth, Jennifer Spinks, Alma Steingart, Oriana Walker, Cecelia Watson, Andrea Westermann, Alexander Wragge-Morley, Nasser Zakariya, Anne Ziemke, Rafaela Teixeira Zorzanelli.



Pre- and postdocs, December 2012. From left to right: Megan McNamee, Oriana Walker, Cecelia Watson, Elena Serrano, Mirjam Brusius, Dan Bouk, Anne Overbeck, Kathleen Vongsathorn, Alma Steingart.

Department III

The research projects in Hans-Jörg Rheinberger's department were completed in 2010. Several conferences and symposia in honor of Hans-Jörg Rheinberger took place to mark this occasion (see p. 197). Since then he has continued his scholarly work as director of the MPIWG. He is also engaged as advisor of the project *History of the Biomedical Institutes* in Berlin-Buch (see p. 124).

The following, unpublished essay is the first result of a larger project in which Hans-Jörg Rheinberger plans to set Gaston Bachelard's epistemological writings in relation to his comprehensive reflections on poetology.

The figures are reprinted with kind permission of Albert Flocon's heirs.

List of Scholars 2010–2012 (for details, see p. 229–268)

Theodore Arabatzis, Safia Azzouni, Elisabetta Basso, Jenny Beckman, Stefan Borchers, Marie-Pier Boucher, Katharina Brandenberger, Christina Brandt, Martin Carrier, Tobias Cheung, Didier Debaise, Tamás Demeter, Thomas Ebke, Judith Friedman, Michael Friedman, Juan Manuel Garrido, Rodolphe Gasché, Bernd Gausemeier, Ina Heumann, Christoph Hoffmann, Giora Hon, Thierry Hoquet, Brad Hume, Stephan Kammer, Josephine Jahn, Iraklis Katsaloulis, Ursula Klein, Peter Konečný, Pamela Kort, Karin Krauthausen, Julia Kursell, Sophie Ledebur-Wicheln, Ximo Guillem Llobat, Carlos López Beltrán, Maria do Mar Gago, Gisela Mateos, Sophie Meyer, Arturo Montoto Echevarría, Omar W. Nasim, Elizabeth Neswald, Lisa Onaga, Laura Otis, Heather Peterson, Jahnavi Phalkey, Irina Podgorny, Sandra Pravica, Carsten Reinhardt, Christian Reiß, Maria Rentetzi, Volker Roelcke, Sophia Roosth, Christoph Rosol, Thomas Schlich, Henning Schmidgen, Peter Schöttler, Jeffrey Schwegman, Norberto Serpente, H. Otto Sibum, Max Stadler, Frank Stahnisch, Catherine Stinson, Pierre Teissier, Georg Christoph Tholen, Magaly Tornay, Sophia Vackimes, Mauro Sebastián Vallejo, Axel Volmar, Silvia Waisse Priven, Mai Wegener, Peter Weingart, Christina Wessely, Barbara Wittmann, Herta Wolf, Monika Wulz, Gábor Áron Zemplén.

Hans-Jörg Rheinberger

Gaston Bachelard and Albert Flocon

On the Encounter of a Philosopher with an Engraver

Albert Flocon

“Paris appeared to me to be the only place in the world where an artist could develop.”¹ Albert Flocon made this confession in his memoirs, which appeared in 1994/95, the year of his death. The sentiment characterizes Albert Flocon’s state of mind at age 24, in 1933, the year he emigrated from Germany to France, where he would live for the rest of his life.

A few biographical notes are in order here, as Flocon is probably not very well known even to Bachelard specialists. I introduce him briefly before turning to the work he pursued together with Gaston Bachelard between 1945 and 1960. Albert Mentzel was born in Köpenick near Berlin in 1909. Between 1927 and 1929, he was a student of Bauhaus in Dessau, where he took courses from the painter Josef Albers and stage designer Oskar Schlemmer. The stage work of the latter had a lasting influence on the later artistic career of Flocon. Having adopted extreme leftist convictions and married a woman of Jewish descent in the early 1930s — an offspring of the Rothschild family in Frankfurt — Flocon decided to emigrate with his young wife to France in 1933. Working in Paris for a number of years in the advertising business, and later in the countryside as a framemaker, he joined the Foreign Legion from 1939 to 1941. He then made connections with the Résistance and was arrested in Toulouse in 1944 together with his family. His wife and daughter were deported and died in Auschwitz. Flocon himself survived in prison. He returned to Paris when the war was over, adopted the surname of a revolutionary French family member of the nineteenth century, Ferdinand Flocon,² and became a French citizen.

1 Albert Flocon, *Points de fuite 1909–1933, Tome 1* (Neuchâtel: Editions Ides et Calendes, 1994), 326. All translations of French quotations into English are by the author of this paper.

2 Ferdinand Flocon (1800–1866) was a radical liberal journalist and writer and member of the Provisional Government of the Second French Republic in 1848. After the coup d’état in 1851, he went into exile in Lausanne, Switzerland.

The Encounter between Flocon and Bachelard, or: The Hand of the Engraver

Flocon began his career as a copper engraver in Paris immediately following World War II. He had begun to occupy himself with perspectival drawings while in prison at Mont St. Michel; friends convinced him that copper engraving would be their ideal medium. His first engraving was “an open hand pointing in a direction, in the palm of which an eye opens; a hand that thus sees, the hand of the engraver.”³ It was later included in his first book, which he edited together with Paul Éluard, who also contributed ten short poems for its ten engravings.⁴ This hand is emblematic of the kind of reflexivity that would become a hallmark of Flocon’s oeuvre and that would soon attract the interest of Gaston Bachelard.

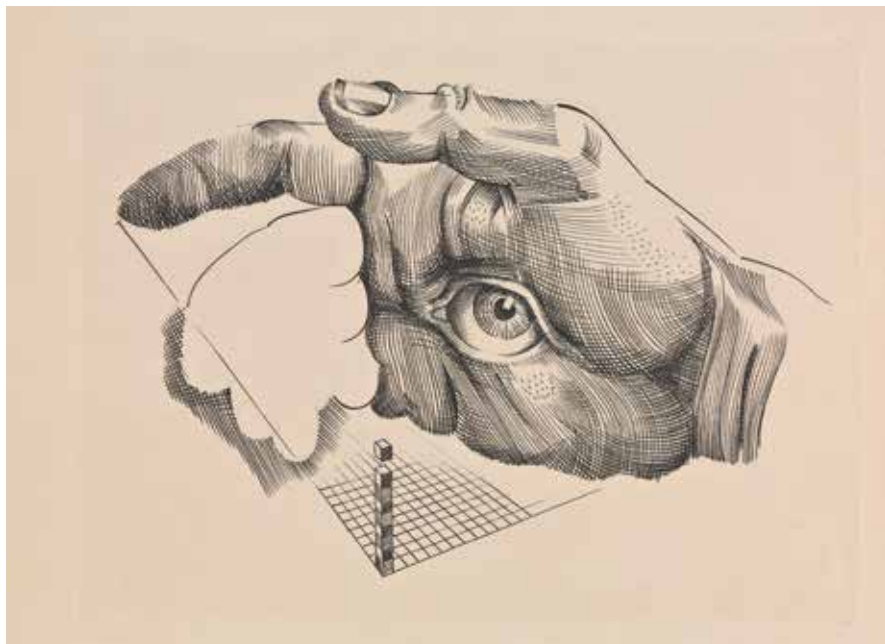

Paul Éluard and Albert Flocon,
Perspectives (Paris: Maeght, 1948), plate 1.
© VG Bild-Kunst, Bonn 2013

After having set up “Graphies” in Paris — a group of artists practicing the art of engraving — Flocon, together with his Swiss colleague Albert Yersin, whom he had met in Paris, set out to organize an exhibition for the group in which the motif of the hand was central. For his preface to the catalog, Flocon envisioned a “montage of citations” from Bachelard’s *La terre et les rêveries de la volonté*,⁵ a recently published book that he had just discovered for himself.⁶ According to Flocon’s memoirs, when he approached Bachelard’s publisher José Corti for permission, Corti suggested that he go and speak with Bachelard himself, which he did, writing the philosopher a letter. They met, and Bachelard told him “one should never print the same things twice,”⁷ and promised to write an extra page for him. Bachelard entitled his text “Matière et

3 Albert Flocon, *Points de fuite, 1933–1994, Tome II* (Neuchâtel: Editions Ides et Calendes, 1995), 134.

4 Paul Éluard and Albert Flocon, *Perspectives: Poèmes sur des gravures de Albert Flocon* (Paris: Maeght, 1948).

5 Flocon, *Points de fuite, 1933–1994*, 143.

6 Gaston Bachelard, *La terre et les rêveries de la volonté* (Paris: José Corti, 1948).

7 Flocon, *Points de fuite, 1933–1994*, 144.

main,” and it became the preface of the collection *A la gloire de la main*, which compiled the imprints of the exhibition.⁸ The publication included the works of Christine Boumeester,⁹ Albert Yersin, and Albert Flocon, and was accompanied by a series of texts from contemporary French writers, among them Francis Ponge, Paul Valéry, and Tristan Tzara. It was printed at the atelier of Georges Leblanc, 147 rue Saint-Jacques, in 1949. Flocon’s print this time shows his own hand — “my hand” — holding an etching needle and engraving a hand — a hand thus “at work” on a hand.¹⁰ At the same time, it presents a sequence of three stages of de- and transfiguration: the corporeal hand, etching the contours of a hand on the copper plate, in which yet another hand appears in the abstracted form of a geometrical sketch.

This book marked the first personal encounter between Bachelard and Flocon. Bachelard noted in his preface: “The successful aesthetic result does not conceal the history of its becoming, the history of the struggle with and against matter.” He added: “This consciousness of the hand at work is reawakened in us when we participate in the métier of the engraver.”¹¹ In this respect, two things fascinated Bachelard and would continue to fascinate him: the forms of resistance in the encounter with matter, and the hand as the material yet knowing agent of a process of construction. As Flocon recalled it, Bachelard was “always curious about the tools, the manipulations, the material work.”¹²



Gaston Bachelard, Paul Éluard, Jean Lescure, Henri Mondor, Francis Ponge, René de Solier, Tristan Tzara, Paul Valéry; Christine Boumeester, R. Chastel, P. Courtin, Sylvain Durand, Jean Fautrier, M. Fiorini, A. Flocon, H. Goetz, Prébandier, Germaine Richier, J. Signovert, R. Ubac, R. Vieillard, Jacques Villon, G. Vuillamy, and A.-E. Yersin, *A la gloire de la main* (Paris, 1949), plate 7. © VG Bild-Kunst, Bonn 2013

8 Gaston Bachelard, Paul Éluard, Jean Lescure, Henri Mondor, Francis Ponge, René de Solier, Tristan Tzara, Paul Valéry; Christine Boumeester, Roger Chastel, Pierre Courtin, Sylvain Durand, Jean Fautrier, Marcel Fiorini, Albert Flocon, Henri Goetz, Léon Prébandier, Germaine Richier, Jean Signovert, Raoul Ubac, Roger Vieillard, Jacques Villon, Gérard Vuillamy, and Albert-Edgar Yersin, *A la gloire de la main* (Paris, 1949).

9 A number of catalogs testifies to the continued contact of Bachelard with artists of this circle, Boumeester in particular: Christine Boumeester, *Instance*, collection “art de demain” (Paris, 1951), with texts by Francis Picabia, Gaston Bachelard, Max Clarac-Serou, Noel Arnaud, and Jaroslav Serpan; Christine Boumeester, *Peintures*. Kerchache – art moderne – 3, rue des beaux-arts, Paris 6, undated (1962).

10 Bachelard et al., *A la gloire de la main*, Plate 7.

11 Bachelard et al., *A la gloire de la main*, 11–12.

12 Flocon, *Points de fuite*, 1933–1994, 144.

The métier of the engraver and his hand are the subject of yet another work, *Le traité du burin*,¹³ in which Flocon attempted to analyze in detail “what goes on at the same time in the head, the hands, and the eyes of an engraver.”¹⁴ Bachelard contributed a preface to this treatise, which presents copper engravings and an accompanying text by Flocon. Here, we see the hand of the engraver in another number of variants, the first two of which are shown here. They appear to perfectly take up the two above-mentioned motifs put forward by Bachelard. One plate shows the effort of the engraver’s hand being resisted by the naked copper; the other embodies the three dimensions of space in a hand which is part of a much larger site under construction. The three tiny figures under the mighty hand appear like marionettes moved by the invisible threads held by the fingers of the hand. “The engraver,” comments Bachelard, “cannot be passive; he does not copy anything; he must produce everything, and produce with a minimum of traits, creating the surfaces by enclosing them, allowing the volumes to emerge by superposition of perspectives alone. Never has the power of constructing been better evoked, invited, planned than in the albums of the engraver- constructor Albert Flocon.”¹⁵

Albert Flocon, *Le traité du burin. Avec une préface de Gaston Bachelard* (Paris: Librairie Auguste Blaizot, 1952), plate on p. 21. © VG Bild-Kunst, Bonn 2013

Albert Flocon, *Le traité du burin. Avec une préface de Gaston Bachelard* (Paris: Librairie Auguste Blaizot, 1952), plate on p. 27. © VG Bild-Kunst, Bonn 2013

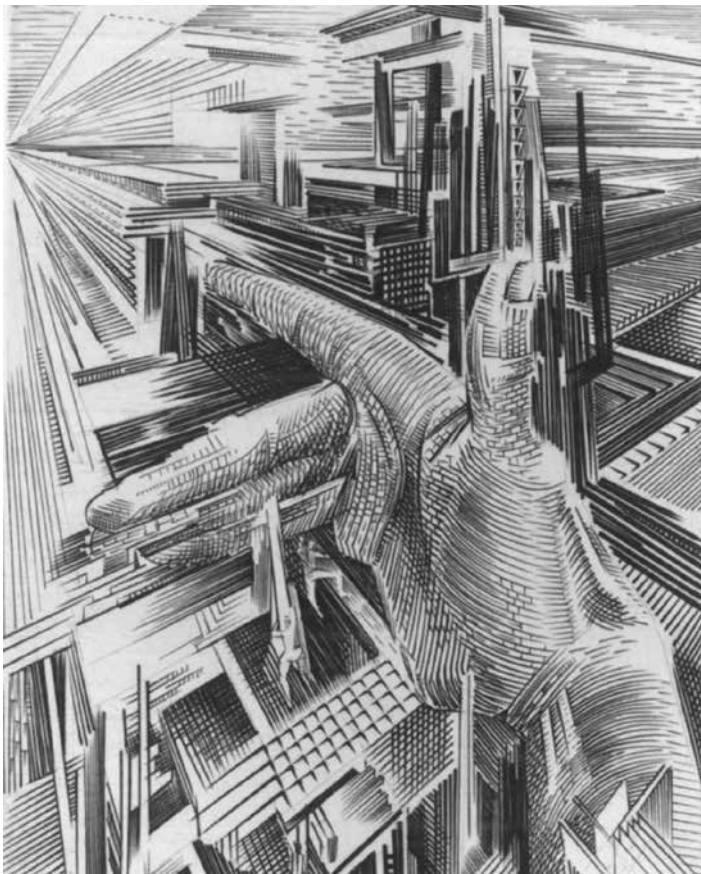

13 Albert Flocon, *Le traité du burin. Avec une préface de Gaston Bachelard* (Paris: Librairie Auguste Blaizot, 1952).

14 Flocon, *Points de fuite*, 1933–1994, 184.

15 Bachelard's preface in Flocon, *Le traité du burin*, 9.

Paysages

A major publication of Flocon's works had appeared a couple of years earlier, for which Bachelard not only wrote the introduction, but also accompanied the engravings with longer texts: *Paysages*.¹⁶ Flocon conceived of the publication as a play of *metamorphosis*, inspired by a series of Bachelard's books, published by José Corti between 1942 and 1948, on his imagined associations of matter, movement, force, and intimacy with the elements: water with matter, air with movement, and earth with volition (force) and rest (intimacy).¹⁷ Fire was still missing; it would become the subject of Bachelard's last book, *La flamme d'une chandelle* (1961).¹⁸ Bachelard saw the "landscapes" of *Paysages* as a primordial instantiation of movement. He thus began his introduction: "Even when he lacks color — the greatest of all sensual seductions — the engraver maintains one possibility: he can, he must find *movement*. [...] The faintest line of an engraving is already trajectory, is movement."¹⁹ Or, as he summarized this point in his conclusion, it is "the taking in possession of the world."²⁰ Bachelard entitled his text "Notes d'un philosophe pour un graveur." Flocon recalled: "I brought Bachelard one or two copper plates per fortnight, so I saw him frequently, and our friendship developed through this shared work where the images precede the text illustrating them."²¹ *Illustration*, however, is not quite the right word here, although the inversion of the usual relationship of illustration points to the specific character of this interaction. Rather, what took place is the creation of two parallel universes, one composed of words, the other of lines. As Bachelard put it: "The notes that I redacted on the engravings of Flocon are the reactions of a solitary philosopher. Lacking other virtues, they display the spontaneity of an isolated dreamer. For the majority of the plates, Flocon and I, we did not seek a 'terrain of understanding.'"²² Thus, no communication in the ordinary sense of the word. Flocon is, however, right in that "the images precede the text," which, in the words of Bachelard, "reacts" to them. For Bachelard, "if the landscape of the poet is a state of the soul, the landscape of the engraver is a character, a fugue of the will, an impatient impulse to act on the world. [...] To provoke is his way of creating."²³ The engraver's work tells the lesson, as Jean Starobinski put it in his review of the book, of the "work on hard matters."²⁴

I cannot go into detail here on all fifteen plates of this remarkable volume. The first four of them have earth, water, air, and fire as their starting points. To take one example, I shall consider the plate following the quaternary elementary introduction. Here, vegetal and human shapes merge into each other. An arm grows into a branch

16 Gaston Bachelard and Albert Flocon, *Paysages*, (Rolle: Paul Eynard, 1950).

17 Gaston Bachelard, *L'eau et les rêves: Essai sur l'imagination de la matière* (Paris: Librairie José Corti, 1942);

Gaston Bachelard, *L'air et les songes: Essai sur l'imagination du mouvement* (Paris: Librairie José Corti, 1943);

Gaston Bachelard, *La terre et les rêveries du repos: Essai sur les images de l'intimité* (Paris: Librairie José Corti, 1948);

Gaston Bachelard, *La terre et les rêveries de la volonté: Essai sur l'imagination des forces* (Paris: Librairie José Corti, 1948).

18 Gaston Bachelard, *La flamme d'une chandelle* (Paris: Presses Universitaires de France, 1961).

19 Bachelard in Bachelard and Flocon, *Paysages*, 9.

20 Bachelard in Bachelard and Flocon, *Paysages*, 18.

21 Flocon, *Points de fuite*, 1933–1994, 182.

22 Bachelard in Bachelard and Flocon, *Paysages*, 50.

23 Bachelard in Bachelard and Flocon, *Paysages*, 10.

24 Jean Starobinski, "Paysages gravés," *Journal de Genève*, January 27, 1951: 3–4, here 4.

that throws off leaves which fly into the horizon; the curved space between body and branch prolongs into a hand; a leg winds itself into the interior of a snail-house anchored in the ground; and the general impression of a jungle-like entwinement repeats itself in more abstract form where the view opens up to the horizon. All of these elementary ingredients emerge from the bottom front of the picture, and between the two legs of the body, growing into the deep forest that surrounds the gigantic, metamorphic struggle of transformation whose movements govern the entire picture. It is not only that vegetal and human forms are constantly interchanging; characteristic of this engraving is that out of interstices grow forms, and forms in turn become interstices. Metamorphosis reigns not only the bodies, but also the very space of the engraver and its possibilities. We see here a continuation of the reflexivity which commanded Flocon's earlier engravings of hands. Bachelard comments on this copper plate: "We are actually at the node of a metabolism of images."²⁵ He does not hesitate to conclude his musings with the following statement: "A life of roots is at the heart of our being. We are actually very old plants."²⁶



Gaston Bachelard and Albert Flocon, *Paysages* (Rolle: Paul Eynard, 1950), plate 5. © VG Bild-Kunst, Bonn 2013

²⁵ Bachelard in Bachelard and Flocon, *Paysages*, 47.

²⁶ Bachelard in Bachelard and Flocon, *Paysages*, 44.

Châteaux en Espagne: Work and Project

“I have made another book with Bachelard,” we read in Flocon’s autobiography, “*Châteaux en Espagne*, for which he wrote the commentary. These are the biggest copper engravings that I have ever engraved; I wanted to make a book with engravings partially without margins, flush-mounted, like in books with photographs.”²⁷ Bachelard reported on the process: “How many histories I have told myself in the course of this whole winter during which, week after week, Albert Flocon brought me the loose pages of his album!”²⁸ He stresses, once more, their silent form of cooperation: “In fact, Flocon has never explained to me what he wanted to make. Between us, no discourse.”²⁹ But Bachelard points right at the center of Flocon’s enterprise when he says, “I love the engraving as such, the autonomous engraving, the engraving that primitively illustrates nothing; the one I call, in my ruminations as a philosopher, the auto-eidetic engraving. It is, for me, the ideal of a story without words, the condensed conte.”³⁰

Bachelard then provides this summary: “Flocon calls his collection: *Châteaux en Espagne*. He thus invites us to measure the distance between what one sees and what one dreams, to traverse what one could call the *project-space*, to live in the *space-time of the project*. It is in this formula that the impenitent philosopher that I am resumes Flocon’s vision: Flocon is the engraver of the *space-time of the project*.”³¹ And projecting means constructing: “He [Flocon] likes to capture an instant of construction where the construction accomplishes the project.”³² We are reminded here of a well-known passage from *The New Scientific Spirit*, in which Bachelard characterizes the modern sciences with the following words: “Above the *subject*, beyond the immediate *object*, modern science grounds itself in the *project*. In scientific thought, the meditation of the object by the subject always takes the form of the project.”³³ A few pages later he summarizes this line of thought: “The real scientific phenomenology is thus essentially a phenomenotechnique. It reinforces what transpires behind what appears. It instructs itself by what it constructs.”³⁴ We touch here at the very core of the resonance between Bachelard the philosopher of science and Flocon the engraver. Bachelard sees Flocon’s oeuvre as epitomizing the take on the world that he also sees at work in the modern experimental sciences — and that, *ceteris paribus*, also distinguishes his own philosophy of science.

The common denominator is that of “philosophy of work.” Thus Bachelard accompanies one of the large plates — a fantastic construction site — of *Châteaux en Espagne* with the following commentary: “Here, we actually have a page on the heroism of

27 Flocon, *Points de fuite*, 1933–1994, 197.

28 Gaston Bachelard and Albert Flocon, *Châteaux en Espagne* (Paris: Cercle Grolhier, Les amis du livre moderne, 1957), 9.

29 Bachelard in Bachelard and Flocon, *Châteaux en Espagne*, 10.

30 Bachelard in Bachelard and Flocon, *Châteaux en Espagne*, 9.

31 Bachelard in Bachelard and Flocon, *Châteaux en Espagne*, 12.

32 Bachelard in Bachelard and Flocon, *Châteaux en Espagne*, 15.

33 Gaston Bachelard, *Le nouvel esprit scientifique*, 10th ed. (Paris: Presses Universitaires de France, 1968), 11.

34 Bachelard, *Le nouvel esprit scientifique*, 13.

work [...] Yes, I would like to have a plate like this one illustrate the philosophy of work. It is more concrete than the plan of an architect, more abstract than an accomplished oeuvre. Here, the engraving is an instant of work, the instant in which the work advances, the project takes form, the form takes shape. Hence, an abstract-concrete plate.”³⁵ It is thus not at all surprising to see that in one of his late epistemological books, *Le rationalisme appliqué*, Bachelard characterizes the type of philosophy that he himself pursues as a “philosophy at work,” in contrast to what he critiques as “philosophies of *résumé*.”³⁶ In Flocon’s strike of the etching needle, he sees “the symbol of a trepan at work in resisting depths. From the first outline, from the primary gesture against hard matter, a primitive tension in the hand determines that the entire body will remain in tension.” He adds: “Confronted with hard matter, one must continue to act.”³⁷ Here we have them, united: scientist, philosopher, and artist. For Bachelard, it seems, the work of the engraver is the instantiation of a phenomenotechnique. If modern physics, as Bachelard claims in one of his early papers, is no longer “a science of facts, but a technology of effects” that fulfills itself no longer in a “description of phenomena but rather a production of phenomena,”³⁸ then the engraver’s work inscribes itself in the same space, the space of “a dialectics of nature and of counternature.”³⁹ It is this constructive element in the work of Flocon that fascinates Bachelard, and that resonates deeply with his own philosophical gesture.

The “château en Espagne” which we see on this plate embodies in an exemplary fashion this dialectics of nature and of counternature. It literally reaches into the clouds. The rock from which it emerges rests on a plain ground on which people are at leisure, at work, and in dispute. In this plate, the relation between foreground and background is strangely inverted: miniaturized human figures in the foreground, mighty blocks of half-trimmed rocks in the background. Flocon introduces a counterperspective in the midst of a classic geometric perspective with its vanishing point on the horizon. In its multiperspectivity, a plate such as this evokes, for Bachelard, “the greatest contingency of contemplation.”⁴⁰ In this engraving, as in so many others of this collection, we see yet another game of vision at play that certainly goes back to Flocon’s stage-work experience during his formative years in Dessau. In a strange, oscillatory triple ambiguity, these engravings always combine elements of a landscape, a stage, and its decoration, so that one never knows exactly where the landscape ends and the stage begins, where the stage ends and the decoration begins, and vice versa. Moreover, each of them contains hidden little surprises and jokes in the form of contingent additions that comment on the scene within the scene.

In his short, programmatic paper on “surrationalism” of 1936, Bachelard presented the following chiasmic formulation for the relation between the sciences and the arts in his time: “One will establish an *experimental reason* that is able to surrationally

35 Bachelard in Bachelard and Flocon, *Châteaux en Espagne*, 26.

36 Gaston Bachelard, *Le rationalisme appliqué* (Paris: Presses Universitaires de France, 1949), 9.

37 Bachelard in Bachelard and Flocon, *Châteaux en Espagne*, 25.

38 Gaston Bachelard, “Noumène et microphysique” [1931–32], in *Etudes* (Paris: Vrin, 1970), 11–24, here 17, 24.

39 Bachelard in Bachelard and Flocon, *Châteaux en Espagne*, 37.

40 Bachelard in Bachelard and Flocon, *Châteaux en Espagne*, 9.

organize the real just as the *experimental dream* of Tristan Tzara surrealistically organizes poetic freedom.”⁴¹ One might be tempted to see the collaboration of Bachelard with a copper engraver twenty years later as the engagement of the philosopher with the work of an artist whose oeuvre embodied this chiasm in one and the same movement: as a surrational organization of the real *and* a surrealist organization of the rational at one and the same time. Here, in the realm of the arts, Bachelard found embodied and could himself act according to the motto offered in his short text on surrationalism: “One has to go in the direction where one thinks most, where one experiments in a most artificial manner, where the ideas are least viscous, where reason likes to be in danger. *If, in an experiment, one does not risk one’s reason, this experiment is not worth being tried.*”⁴²



Gaston Bachelard and Albert Flocon, *Châteaux en Espagne* (Paris: Cercle Grolier, Les amis du livre moderne, 1957), plate on p. 27. © VG Bild-Kunst, Bonn 2013

41 Gaston Bachelard, “Le surrationalisme,” *Inquisitions: Organe du groupe d’études pour la phénoménologie humaine* 1 (June 1936): 1–6, here 1–2. There appeared only one issue of this journal directed by Louis Aragon, Roger Caillois, Jules M. Monnerot, and Tristan Tzara.

42 Bachelard, “Le surrationalisme,” 4–5 (italics in the original).

Project

History of the Biomedical Institutes in Berlin-Buch

RESEARCH SCHOLAR *Bernd Gausemeier*

DOCTORAL STUDENTS *Sophie Meyer, Josephine Jahn*

FUNDING Max Delbrück Center, Berlin-Buch

General Description

Berlin-Buch is one of the most prominent sites of the German life sciences. In 1930, the Kaiser Wilhelm Society established its Institute for Brain Research (KWIH), a research center characterized by a novel interdisciplinary structure combining neuropathological and neurophysiological approaches with neurobiochemistry, genetics, and linguistics. After World War II, the German Academy of Sciences took over the Buch facilities and formed the Institute for Medicine and Biology, which brought together clinical cancer research with independent departments for biophysics, biochemistry, cell biology, and pharmacology. The institute steadily grew into East Germany's most important center for biomedical research, integrating new fields of molecular biology and experimental medicine in the process. By the beginning of the 1970s, the institute complex was split up into the Central Institutes for Molecular Biology, for Cancer Research, and for Cardiovascular Research.

Embracing various key fields of the modern life sciences, the history of this institute complex traces pivotal developments and long-term trends characterizing twentieth-century biology and medicine, from basic science to clinical application. Moreover, the institutes' prominent position in the respective national research systems provides valuable insights into the political and economic processes shaping the structures and contents of science.

Individual Projects

Bernd Gausemeier

History of the Biomedical Institutes in Berlin-Buch

The primary aim of this project, which began in March 2011, is a monograph covering the complete history of the Buch institutes from the foundation of the KWIH to the dissolution of the Central Institutes of the East German Academy in 1991. This undertaking involves comprehensive studies of archival and printed sources as well as numerous interviews with contemporary witnesses. Although the developments before and after 1945 are mainly connected through a continuity of place, it will be possible to carve out common threads such as the conjunction between clinical and laboratory-based research, the peculiarities of suburban isolation, and conflicts between nonuniversity institutes and universities.

The study will use institutional history as a viewpoint for observing political, social, and economic constellations in which German science in the twentieth century was embedded. The KWIH had an especially eventful political history, reflecting the dramatic changes in interwar Germany. Originally conceived before World War I and long protracted by the crisis of the Weimar years, the plans for an institute building were finally realized owing to the interplay of German big business, state bureaucracy, and American foundation capital. The Nazis' rise to power brought partly violent attacks by Nazi activists, which ultimately resulted in the withdrawal of the institute's founding director Oskar Vogt in 1937. The remodeled institute eventually became involved in the use of the brains of patients killed in the Nazi euthanasia campaign, an especially striking example of the gradual dehumanization of German science beginning in 1933.

The history of the Institutes for Medicine and Biology after 1945 serves as a model for the East German research system on the whole. Because the institutes were usually well connected with central agencies of research management and partly assumed quasi-administrative functions (e.g., in the coordination of national cancer research and care), they provide a good starting point for analyzing the basic structures of science policy, economic aspects of research, and the political control of institutions in the GDR. The institutes' history sheds light on the economic problems that constrained and shaped the direction of research in the GDR. Correspondingly, it reflects basic political shifts that have transformed East German society, from the insecurity of the early Stalinist years to a period of relative autonomy of science up to the implementation of pervading party influence in the 1970s.



Bernd Gausemeier

Kaiser-Wilhelm-Institut für Hirnforschung about 1930. Comtemporary postcard.



Special attention will be devoted to the economic dimensions of research, namely, problems of material supply, infrastructure planning, the development and application of research technologies, and laboratory–industry relations. This approach is fruitful not only because the shortage of resources was a continuous characteristic of science in the “planned economy” of the GDR. It also offers an appropriate way to follow the long-term growth of “big science” structures and highlights their general dependence on the economic systems that surround them. The history of the Buch institutes comprises numerous examples of how infrastructural problems or large technologies (such as radiation sources) affect the course of research. But also everyday conflicts over the availability of equipment, laboratory animals, or chemicals can point to important economic conditions.

Another focal point of the study arises from the close connection between clinics and laboratories that characterized the Buch institutes from their beginnings. The presence of a neurological clinic in the KWIH raises questions about the ethical implications of access to patients with neurological and psychiatric disorders. The incorporation of two clinics (cancer and hypertension therapy) in the Institute for Medicine and Biology was explicitly conceived to ensure a steady flow of results from “basic research” to clinical application, and vice versa. The often severe internal conflicts resulting from this concept, as well as practical attempts to realize transfers between laboratory and bedside, deserve special consideration. Moreover, the history of the clinics provides an overview of basic diagnostic and therapeutic trends in two of the most important fields of modern medicine.

Finally, the book will include in-depth perspectives on research on the Buch campus. In view of the multitude of research topics followed before and after the war, it will be necessary to concentrate on projects that were either trailblazing, representative of a trend in a particular discipline, or formative for the institute’s development. Though the Institutes of the Academy were widely engaged in “catching up” with new standards set by Western biomedicine, some groups were able to keep pace with the international vanguard or even to define standards. Such was the case for tumor virology, the biochemistry of the cardiac muscle, the formulation of mathematical models for metabolic pathways, and the development of biosensors. Case studies analyzing these fields will help to expand the historiographic picture of the life sciences after World War II, which is still largely focused on the “main roads” leading to modern genomics. They also highlight central aspects of modern biomedicine, such as the circulation of model objects and test systems, the interplay of “basic” molecular biology and “applied” pharmaceutical research, the computerization and automatization of biophysics and biochemistry, and the mechanisms of international information flows and professional recognition.

Overall, the project aims at a *longue durée* perspective on the modern life sciences. It aims to integrate insights from microhistorical views of scientific practices into the framework of institutional history. The monographic presentation of the results will combine questions relevant to the historiographies of science, medicine, and technology with outlooks on political, economic, and social history.

Sophie Meyer

Tumor Immunology in Berlin-Buch, 1958–1985

This dissertation project, which began in July 2011, deals with the history of immunobiological research in Berlin-Buch from the late 1950s to the 1980s. Since the late 1960s, immunobiology received special attention from the national research management of the GDR, corresponding to the growing international significance of the field. The project traces the emergence of immunobiological approaches both in the framework of Arnold Graffi's cancer virology program and in the cancer clinic, the formation of an independent immunological group and its integration into a nationwide program that aimed at linking tumor immunology and transplantation immunology. Special attention will be devoted to projects reflecting the expert debates in the field, such as the development of immunological cancer test systems and the search for new experimental models following the abandonment of carcinogenic viruses.

By analyzing these developments, the project will provide detailed insight into the making of a scientific discipline in a small country, the management of “catching up” processes in the framework of a planned economy, differences between the respective approaches of clinicians and “basic researchers”, and the cooperation between Buch and external institutes and clinics. Because the Buch immunobiologists were relatively well integrated into the international community of immunobiologists, the project will also trace the transfer of techniques and ideas. Finally, this case study will broaden the historical understanding of political contexts that have shaped a key discipline of the modern life sciences.



Sophie Meyer

Josephine Jahn

Biomedical Research and Clinical Practice at the Central Institute for Cancer Research

This dissertation project, which began in August 2012, examines the interactions between laboratory research and clinical research at the Central Institute for Cancer Research from the 1960s to the 1980s. The formation of this institute was an attempt to integrate basic biological research into clinical practice. The study investigates to what extent the presence of an in-house clinic affected the work of “basic researchers,” and to what extent laboratory results entered the clinical sphere. These questions will be explored primarily in the context of the development of chemotherapeutic substances and application methods. This field serves as an exemplary case because chemotherapeutic drug research involved several research groups and practices; in addition, it touches on relations with the neighboring Central Institute for Molecular Biology, the pharmaceutical industry, and other clinical institutions. The project will intensively draw on interviews with contemporary witnesses, and thus access information about everyday research practices as well as insights into the social relations between the clinical staff and laboratory scientists.



Josephine Jahn

Katrin von Lehmann (Artist in Residence),
from the series: "Blick auf Vielfalt,"
36 x 51 cm, Zeichnung,
Drawing, Perforation, Paper, 2012.
Photo: Bernd Hiepe.



Max Planck Research Group

Twentieth Century Histories of Knowledge About Human Variation

Director: *Veronika Lipphardt*

Introduction

The diversity of humankind has been an abidingly explosive political, moral, and scientific issue throughout the twentieth century. Many hoped that the tools of the life sciences would provide neutral and authoritative ways of studying biological differences between human groups. Others argued that the questions, practices, and institutions involved in the study of human diversity perpetuated racist prejudices. This research group seeks to find ways of historicizing and contextualizing this discourse. Which classifications, practices, concepts, and tools did scientists employ in order to produce and assess human diversity? How did they narrate, visualize, and represent diversity? What kind of epistemic object was “human variation”? What kind of human variation did scientists consider to be “biological,” and how did they conceive of “nature” as its cause? How were the contemporary social and political uses of diversity reflected and embedded in scientists’ work?

To explore these questions, this interdisciplinary group recognizes the analytic potential of following research practices, technologies, institutions, networks, narratives, and representational devices. This array of approaches are bringing into view a range of contexts and disciplines that used human variation as a scholarly focus or epistemic instrument, even if they did not explicitly contribute to “race science.” In particular, the group seeks to bring into view the ways that physicians, demographers, and epidemiologists — as well as life scientists — imagined, researched, and described human variation in European, colonial, and postcolonial contexts. Only with this expanded perspective can one understand and critically assess the political concerns around the production of scientific facts about human difference.

The importance of human (population) genetics in the study of human variation by the mid-twentieth century has been a key research focus. However, the group also emphasizes that life scientists heavily relied on the social sciences and the humanities as well as (nonacademic) cultural traditions in order to generate knowledge about human variation. The group has been able to demonstrate multiple understandings of diversity that combined genetic and other markers of population difference, such as in the study of population size or nutrition.

In view of these complexities, the group takes interdisciplinarity seriously and seeks to bring historians into dialogue with scholars from the humanities, the social sciences, and the life sciences. Significantly, the group includes several social anthropologists who offer a particularly strong sensibility toward the ways in which social and political identities are negotiated in daily life. One focus of these discussions has been how difference becomes produced in the course of research practices. The active participation of our artist in residence, Katrin von Lehmann, has added fruitfully to this dialogue.

This work is making clear the importance of social and political administrative networks, health-care systems, and other infrastructures in producing and circulating knowledge about human variation. These engagements brought up new themes, such as the ubiquity of bio-historical narratives, and the great impact of “isolation.” The idea of the isolation of human groups cuts across methodologies of sampling and evolutionary narrations of group history, in science as well as in other cultural traditions. The dynamics of political power are especially important. For this reason, group members pay careful attention to the relationship between knowledge of human variation and national identities. In particular, we bring into view the place of these sciences in the administration of European colonies, but also in struggles of postcolonial independence and nation-building. Another set of historical constellations with high political relevance is the group’s work on claims of Jewish difference.

As the individual reports show in more detail, the range of case studies addressed by the group spans the twentieth century and covers many regions of the world. They bring into view a rich collection of encounters between researchers and test subjects, as well as the global scope of scientific endeavors to understand human variation. Through workshops, a seminar series, collaborations with other scholars and research groups, and an extensive guest program, this research group has created productive forums to bring scholars into dialogue on this research agenda.

Individual Projects

Veronika Lipphardt (Research Group Director and Professor, Freie Universität Berlin)

Studies of Human Variation Between the Paradigms of “Race” and “Population”

This project focuses on population genetics and physical anthropology in the 1950s and early 1960s, when scientists researching human variation discussed whether “race” was still a usable scientific term. Historians have already documented those scientists’ political debates about racism. This project takes a different approach, concentrating first on their internal debates about methodological and conceptual issues and second on their empirical work, contextualizing both in relation to contemporary politics. It focuses on the research practices, conceptual tools, and cultural traditions that have shaped empirical studies about human variation.

The publications and talks produced from this project have stressed the importance of bio-historical narratives — particularly those of isolation, migration, and admixture. They show how these narratives helped scientists to frame both their research design and the history of the group under study — a necessary step for sampling. This project establishes that the practices of sampling and labeling of groups are crucial to the outcome of any study of human variation. These activities and decisions are dependent on locally, culturally, socially, and politically contingent factors, for example power relations and informative contacts.

The case studies include human variation studies in India, Africa, Israel, Brazil, and Siberia. This project reveals that knowledge about human genetic variation was predominantly produced in colonial and postcolonial contexts or other politically charged circumstances in which scientists hoped to find “isolated” or “mixed” groups. Investigating human variation was not a laboratory endeavor: it required social interactions and confronted scientists with tensions between minorities and majorities.

A major achievement of this project is to point to the enduring importance of “isolation” as a conceptual tool. Claims that certain groups had remained isolated — socially, biologically, culturally — ran through nineteenth- and twentieth-century stories about origin, identity, and humankind’s “infinite diversity.” It made disciplines, cultural traditions, and political conflicts compatible with one another. In the 1950s, the concept of isolation, reframed in the rhetoric of the modern evolutionary synthesis,



Veronika Lipphardt

A UNESCO brochure interprets the idea of genetic variation by reproductive isolation to a broader public, from “What is race? Evidence from Scientists”, pp. 38–39, illustrations by JaneEakin Kleiman and texts by Diana Tead, © UNESCO 1952. Used by permission of UNESCO.



helped geneticists to make use of classifications and data from older race studies, but shift the focus of variation studies to theoretical questions of human evolution and genetics.

Publications and talks from this project give a first general overview of the early phase of human population genetics and carefully delineate this field from the much better studied history of medical genetics. This work suggests that there was no shift away from race science after 1945; rather, certain important practices shifted only in the late 1960s, a significant one being the use and calibration of new genetic markers.

Veronika Lipphardt has worked on broader issues, including knowledge transfers in a global and social perspective, “race” in the humanities, the interesting discrepancies between Franz Boas’s English and German publications, and a transfer of Hayden White’s metahistory to evolution biology.

Events Veronika Lipphardt has organized or co-organized include three international workshops, the panel “Creating a World Population: The Global Transfer of Population-Control Technologies” at the Historikertag (2010, Berlin), the group’s seminar series and extensive guest program, and the first Berlin Doctoral Students’ Forum (together with Sven Dupré).

At the Freie Universität Berlin she has supervised two PhD students and taught one or two courses per semester, except during medical leave (December 2010–March 2011) and parental leave (April 2011–January 2012).



Susanne Bauer

Susanne Bauer (Research Scholar 09/2009–12/2011)

Micropolitics of Difference: Soviet/Russian Biomedical Science from the Atomic Age to the Era of Genomics

This project historicized notions and practices of diversity research in the life sciences, focusing on population studies in Soviet and post-Soviet contexts. In particular, it followed three main threads: (a) the early Soviet technique of genogeography and the mapping of human genetic diversity post-Lysenko, (b) cytogenetic techniques in mutation research and health sciences, and (c) practices of epidemiological databasing. For this project, Susanne Bauer conducted archival research on the history of medical genetics at the Academy of Medical Sciences in Moscow, and in Almaty, Kazakhstan, during 2010 and 2011.

The Soviet Union was often represented by a blank space on geographical maps produced by Western medical geneticists and serological anthropologists. Yet the very concept and practice of genogeographic mapping was first developed in early Soviet science. Dismissed during the Lysenko era, classical genetics, including medical genetics, was re-established by the late 1960s and became an active research area of Soviet biological anthropology and human genetics.

One part of this project followed these non-Western projects of diversity research over the course of the twentieth century, in particular examining an atlas of the gene pool (генофонд) of the population in the Soviet Union. These materials were used to explore the ways in which data collecting and modeling co-shaped topologies of belonging in late Soviet and post-Soviet society.

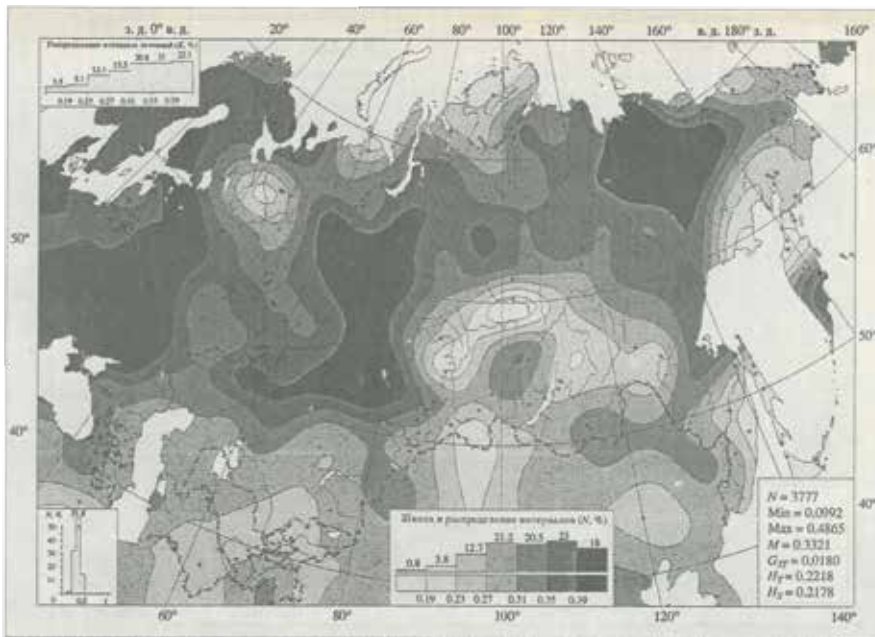

Example of a genogeographic map generated by computer modeling visualizing a “frequency distribution of Hp1 in North-Eastern Eurasia.” E. V. Balanovskaia and S. D. Nurbaev. “Computer Technology of Genogeographic Analysis of a Gene Pool.” *Genetika* 31, no. 4 (1995): 540.

A second thread of the project explored the role of cytogenetics and mutation studies in Soviet biomedical sciences. With the broad implementation of cytogenetic techniques during the 1970s, scientists scaled up mutation research using drosophila and radiation genetics to cytogenetic monitoring of the human population. Their efforts translated into mutation surveillance through prenatal testing and mutagen monitoring as part of environmental regulation. In order to explore the relationship between radiation biology and public health in various contexts, Susanne Bauer organized the panel “Radiation Exposures as Sites of Knowledge Production” at the 2010 Annual Meeting of the Society for the Social Studies of Science (4S) in Tokyo.

The third part of the project focused on notions of differences and diversity in large population databases at the level of infrastructures, exploring the performativity of mapmaking, statistical modeling, and epidemiological databasing practices. The paper “Modeling Population Health: Reflections on the Performativity of Epidemiological Research” has been accepted for publication in *Medical Anthropology Quarterly*. Databases were also at the core of the international workshop “Data – Difference – Diversity: Technologies of Differentiation in the Life Sciences,” which Susanne Bauer co-organized in 2011. The workshop brought together scholars working on how emerging information technologies and data infrastructures co-shaped endeavors to monitor life in the second half of the twentieth century.

In the Fall 2011 term, Susanne Bauer was a visiting professor at the History and Philosophy of Science Center and the Collins Living-Learning Center, Indiana University, Bloomington, and taught the interdisciplinary course “Atomic Challenges: Nuclear Sciences and Biomedicine during the Cold War.” As of January 1, 2012, Susanne Bauer joined the faculty in the Department of Sociology at Goethe-Universität Frankfurt as a professor in the sociology of science.



Alexandra Widmer

Alexandra Widmer (Postdoctoral Scholar, Research Scholar)

Scandalous Subjects: Island Lives and Demographic Anxieties from Race to Development in Melanesia

This project examines how scientific experts produced and used knowledge of human variation in research on the growth and decline of human populations. In the first three decades of the twentieth century, researchers from a wide variety of disciplines described changes in human population size in debates about racial and cultural adaptations in evolution. In the postwar era, demography became a formal discipline as demographers popularized the “demographic transition theory” and saw suboptimal population size as the result of problematic traditions that needed to be modernized. From the vantage point of Vanuatu (former New Hebrides), an archipelago in the southwestern Pacific, the project explores how scientific understandings of population size were associated with colonial strategies to curb “racial” decline and later

plans to balance fertility with economic development. Whether the population was declining or growing, demographic knowledge was associated with potential scandals in the extinction of the “race” in the 1920s, or social problems related to unmet development needs by the 1970s.

Missionary Dr. Frater's letter to British Resident Commissioner of the New Hebrides. Western Pacific Archive, University of Auckland Library.

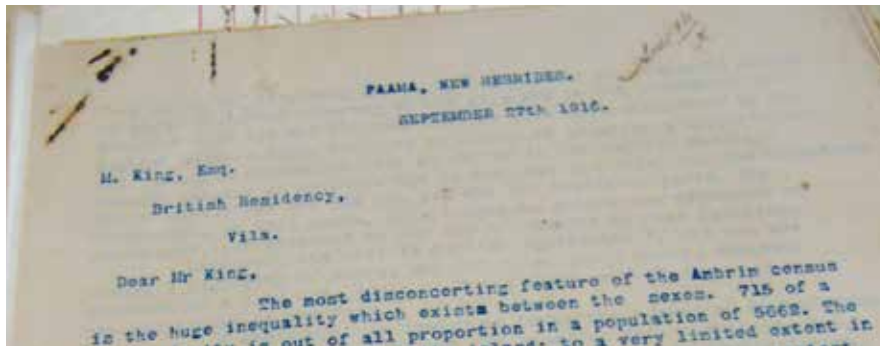

With its focus on demographic practices and narratives of reproduction, this project aims to expand the historiography of human variation studies beyond an emphasis on genetics. By choosing to analyze population debates and colonial administration in culturally diverse colonial Melanesia, this project also highlights the centrality of social conditions entangled in the scientific study of diverse human populations.

Alexandra Widmer brought these research directions to the international workshop which she co-organized on colonial administration and scientific research on population health. Her own experience with the complexities of ethnographic fieldwork contributed to her historical research on the place of cross-cultural encounters in the production of scientific knowledge of Melanesians by interwar population experts (published in *Paideuma*, 2012), and the geneticist D. C. Gajdusek (forthcoming in *Studies in the History and Philosophy of Biological and Biomedical Sciences*).

One focus of this project has been to track twentieth-century research on the human sex-ratio and population size. The debates about sex-ratios are relevant to the historiography of race in science for what they reveal about the spectrum of factors that scientists took into account in order to understand human difference. The differential survival rate of the sexes at different points in an individual life cycle could be attributed to heritable, cultural, or social factors, leading to population growth or decline. Unlike characteristics such as skin color or hair texture, which could be reduced to heritable traits, sex-ratios were methodologically related to both cultural and biological aspects that marked populations as distinct. This epistemic nexus underpinned colonial interventions to reform sexuality and kinship at a population level in

the New Hebrides by means of a policy to reduce the “bride price” and improve low fertility in the 1920s.

In overlapping administrative and epistemic registers, concerns about reproduction and sex ratios reveal the historical and abiding relationship between sexual selection, sex, and race, as well as kinship and race. These topics are discussed in her contribution to the forthcoming edited collection *Technologies of Belonging: Biology, Race and Ethnicity in Europe* in the journal *Science, Technology, and Human Values*.

Jenny Bangham (Postdoctoral Research Fellow)

Blood Groups and the Making of Human Genetics in Mid-Twentieth-Century Britain

In 1955, American geneticist Leslie C. Dunn — director of the Institute for the Study of Human Variation at Columbia University in New York — authored a paper in the *American Naturalist* entitled “The Coming of Age of Blood Group Research.” In it, Dunn marveled at how in only a little over thirty years, blood groups had gone from being immunological curiosities to tools for a new “objective” physical anthropology, “research instruments” for studying evolution, and indispensable to hospitals, clinics, transfusion centers, and forensic laboratories. Dunn reflected on the great diversity of workers using blood groups, including “medical researchers, transfusion officers, blood banks, serologists, hematologists, anthropologists, statisticians, and theoretical biologists.”



Jenny Bangham

Arthur Mourant’s work-in-progress to produce maps of blood-group diversity of North Africa. Isolines sketched with red pen are superimposed on a 1930s map of Morocco and the geographical distributions of its “tribes.” By permission of the Wellcome Library, London.

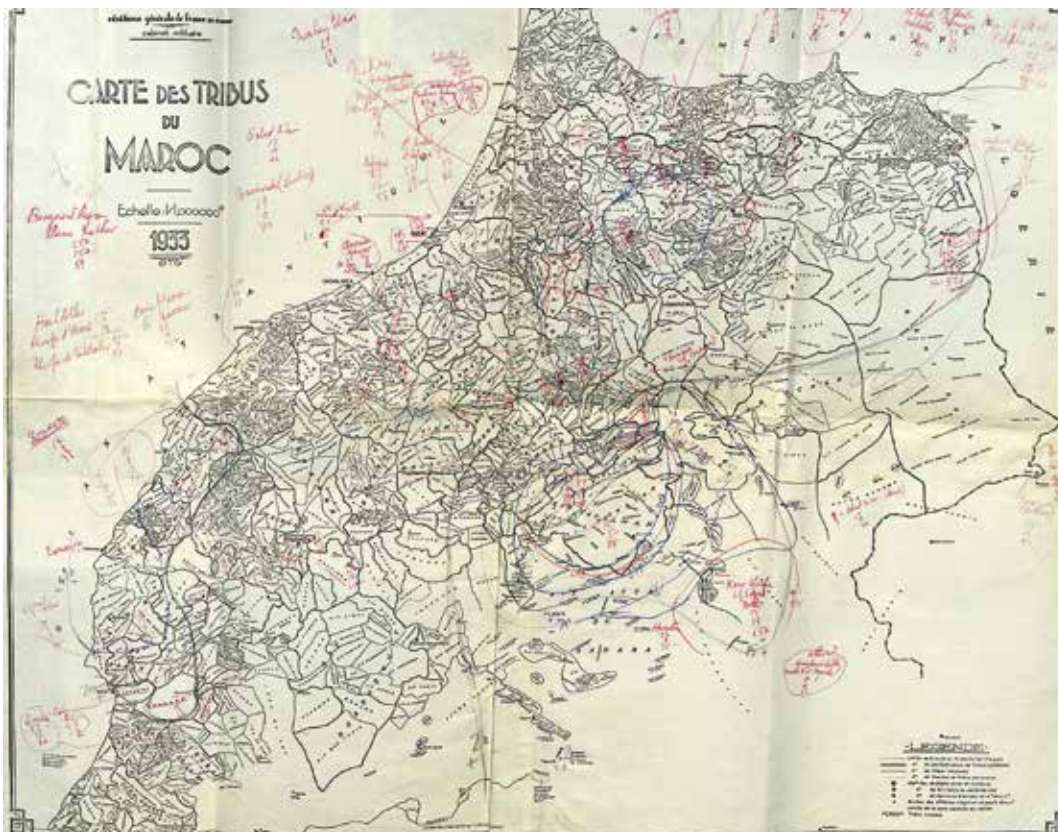

This project is concerned with the construction of blood groups as objects of genetic research in the mid-twentieth century, and in particular with the ways in which they were shared and represented by workers in different settings. In the mid-1950s, blood groups were almost the only human traits whose inheritance could be expressed in Mendelian terms, and had become the cornerstone for a quantitative and objective approach to understanding the genetics of human disease. At least a third of all papers published in Britain's premier journal for human heredity — the *Annals of Human Genetics* — included work on blood groups, while many geneticists proclaimed that they were the basis for a purified, unprejudiced postwar race science.

The flourishing of blood group research happened at precisely the time that human geneticists were establishing their own journals, conferences, and textbooks, so this project is partly about how blood groups helped to consolidate the discipline of human genetics. Blood groups as genetic objects were not simply co-opted by researchers, but simultaneously fashioned this emerging discipline by mediating the circulation and calibration of scientific knowledge between different domains.

This project also contributes to a growing body of literature on the epistemic and practical functions of routine tools in science. One way in which blood groups took material form was as inscriptions, thus tracing nomenclatures is helping to recover the ways in which the meanings of blood groups were negotiated. From this work a forthcoming paper in the *British Journal for the History of Science* offers a sustained analysis of the functions of nomenclatures in blood group research and genetics more generally.

Continuing this focus on administrative tools, Jenny Bangham and group guest Soraya de Chadarevian (University of California Los Angeles) co-organized the workshop “Making Human Heredity: Populations and Public Health in the Postwar Era” (Department of History and Philosophy of Science, University of Cambridge, UK), which considered how methods of collecting and cataloguing data shaped the postwar study of human heredity. Three additional members of the group — Veronika Lipphardt, Alexandra Widmer, and Susanne Bauer — also presented papers at the workshop. Jenny Bangham and Soraya de Chadarevian are co-editing the workshop's papers for a special issue of *Studies in the History and Philosophy of Biological and Biomedical Sciences*.

“Melting pot of peoples in Europe before the twelfth century,” from “What is race? Evidence from Scientists”, p. 40, illustrations by Jane Eakin Kleiman and texts by Diana Tead, © UNESCO 1952. Used by permission of UNESCO.



Staffan Müller-Wille (Visiting Scholar, University of Exeter, UK)

Race and Progress: Towards an Epistemological History of the Race Concept

The concept of race certainly constitutes one of the most problematic legacies of the Enlightenment. Most of the existing historiography on this concept frames its subject by two discontinuities. At the beginning of the story, we have the invention of race by European naturalists and anthropologists, marked by the publication of the book *Systema naturae*, in 1735, in which the Swedish naturalist Carl Linnaeus proposed a classification of humankind into four distinct races. And at its end stands the demise of race as a viable biological concept after World War II in favor of population-genetic conceptions of human diversity, again prominently marked by the “UNESCO Statement on Race” issued in 1950. Race is thus insulated from properly conducted, rational discourse and treated as a subject which, if at all, can only be understood as a residue of long-outdated forms of typological and hierarchical thinking.

Staffan Müller-Wille has undertaken conceptual and empirical work aimed at challenging some common assumptions that underwrite the standard historiography, not in order to legitimize racialism, but in order to understand better why race has been, and continues to be, such a politically explosive concept. Conceptually, he has tried to develop an approach to the history of race based on an understanding of concepts as mental tools, rather than mental representations. A concept in this understanding does not somehow mirror its object, but rather serves as an anchoring point for evaluations and judgments. The racial classifications of humans according to skin

color that were proposed in the eighteenth century, for example, did not serve to identify discrete and stable types, but rather bear more similarity to the abstract grid of parallels and meridians that underlie geographical maps. Rather than depicting some reality “out there,” they served as tools for ordering existing knowledge and providing orientation for future action.

Empirical work was conducted on two levels. On the first level, bibliographic research attempted to uncover the sources on which some early critical work on the history of race and racism, especially by Hannah Arendt and Michel Foucault, relied. This research revealed that the late nineteenth and early twentieth centuries witnessed some astoundingly dynamic and highly reflective notions of race. On a second level, Müller-Wille carried out some focused case studies. One of these concerned Franz Boas’s (1858–1942) anthropometric studies on a number of First Nations. A detailed study of the original data sheets, which are preserved at the American Philosophical Library, and their statistical processing revealed how key elements of the concept of “family line,” which Boas later developed in the context of his critique of racial formalism, grew inadvertently from the data collection and processing practices of these anthropometric studies.



Staffan
Müller-Wille

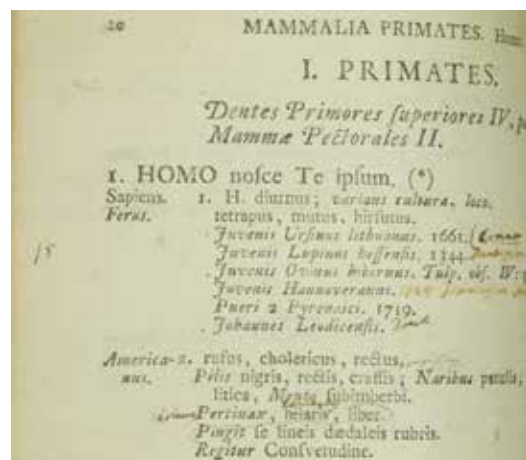

Detail from Carl Linnaeus, *Systema Naturae*, 10th edition (Stockholm, 1760), with annotations by the author. By permission of the Linnean Society of London.

Workshops

Workshop

Sciences of Communication in the Twentieth Century

March 18–20, 2010

ORGANIZERS *Veronika Lipphardt* (MPIWG), *Tania Munz* (MPIWG)

KEYNOTE SPEAKER *Regna Darnell* (University of Western Ontario)

This workshop was a cooperation with Department II.



The study of communication is a rich locus for beliefs about similarities and differences across time, space, cultures, and species. From attempts to catalog disappearing languages to the rise of universal grammars, from cybernetics to communicating chimpanzees and honeybees, the twentieth century yielded a remarkably broad range of activities surrounding the study of language. This workshop examined the range of disciplinary approaches to language and the objects of their study in order to consider what a historical examination of language studies tells us about the complex interrelations between twentieth-century human and natural sciences. One focus of this workshop was the long-standing cooperation between linguistics and physical anthropology and human genetics on the topic of human variation.

Participants

- *Stephen G. Alter* (Gordon College, USA)
- *Stefan Bargheer* (MPIWG/University of California, Los Angeles, USA)
- *Jamie Cohen-Cole* (Harvard University, USA)
- *Regna Darnell* (University of Western Ontario, Canada)
- *Lorraine Daston* (MPIWG)
- *Slava Gerovitch* (Massachusetts Institute of Technology, USA)
- *Michael Gordin* (Princeton University, USA)
- *Randy Harris* (University of Waterloo, Canada)
- *John E. Joseph* (University of Edinburgh, UK)
- *Judy Kaplan* (Ann Arbor, USA)
- *Veronika Lipphardt* (Research Group Leader MPIWG/Freie Universität Berlin, Germany)
- *David Ludwig* (MPIWG)
- *Tania Munz* (MPIWG; as of September 2010, Northwestern University, USA)
- *Gregory Radick* (University of Leeds, UK)
- *Robert Richards* (University of Chicago, USA)
- *Thomas Sturm* (Universitat Autònoma de Barcelona, Spain)

Workshop

Data – Difference – Diversity

November 24–26, 2011

ORGANIZERS *Susanne Bauer* (MPIWG), *Christine Hanke* (KHM Köln),
Sabine Höhler (KTH Stockholm)

This workshop explored the modes and technologies of differentiation at work in the production of difference/diversity in the late twentieth century, in particular in biomedicine and ecology. Although the two fields address distinct levels (diversity within species, diversity of species and habitats), they involve similar frameworks and practices in knowledge production — co-shaped by “big science” projects, information technologies, and the “new genetics.” In both fields, data accumulation and storage through digital technologies were accompanied by earth-spanning research projects and endeavors to monitor life. The workshop’s main focus was on developments since the early 1970s, when information technologies and electronic infrastructures began to speed up data processing and exchange in the life sciences.

Participants

- *Susanne Bauer* (MPIWG)
- *Etienne Benson* (MPIWG)
- *Soraya de Chadarevian* (University of California, Los Angeles, USA)
- *Gabriele Gramelsberger* (Freie Universität Berlin, Germany)
- *Orit Halpern* (The New School for Social Research, New York, USA)
- *Christine Hanke* (Kunsthochschule für Medien Köln, Germany)
- *Sabine Höhler* (KTH Royal Institute of Technology, Stockholm, Sweden)
- *Felix Keller* (Universität St. Gallen, Switzerland)
- *Thomas Lemke* (Goethe Universität Frankfurt am Main, Germany)
- *Sabina Leonelli* (University of Exeter, UK)
- *Veronika Lipphardt* (MPIWG/Freie Universität Berlin, Germany)
- *Adrian Mackenzie* (Lancaster University, UK)
- *Erika Mansnerus* (London School of Economics, UK)
- *Ruth McNally* (Lancaster University, UK)
- *Martina Merz* (Universität Luzern, Switzerland)
- *Staffan Müller-Wille* (MPIWG/University of Exeter, UK)
- *Michelle Murphy* (University of Toronto, Canada)
- *Britt Ross Winthereik* (IT University of Copenhagen, Denmark)
- *Bruno J. Strasser* (Yale University, USA)



Workshop

Population Diversities Past and Present: Stakes, Genealogies, Taboos

April 19, 2012

ORGANIZER *Alexandra Widmer* (MPIWG)

The aim of this reflexive workshop was to bring scholars who analyze the social implications of contemporary sciences of human diversity into dialogue with historically oriented colleagues working on earlier contexts. Participants explored the place of history in the methods and epistemology of contemporary forensics and the Hap-Map project, as well as how history shapes the stakes and taboos for both scientific and scholarly work on population genetics in South Africa and personalized medicine in Canada. The workshop challenged scholars to think about how the contemporary world frames historical inquiry.

Participants

- *Sarah Blacker* (University of Alberta, Canada)
- *Joan H. Fujimura* (University of Wisconsin-Madison, USA)
- *Veronika Lipphardt* (MPIWG)
- *Amade M'charek* (University of Amsterdam, The Netherlands)
- *Robert Meunier* (MPIWG)
- *Staffan Müller-Wille* (MPIWG)
- *Katharina Schramm* (Martin-Luther-Universität, Halle-Wittenberg, Germany)
- *Alexandra Widmer* (MPIWG)

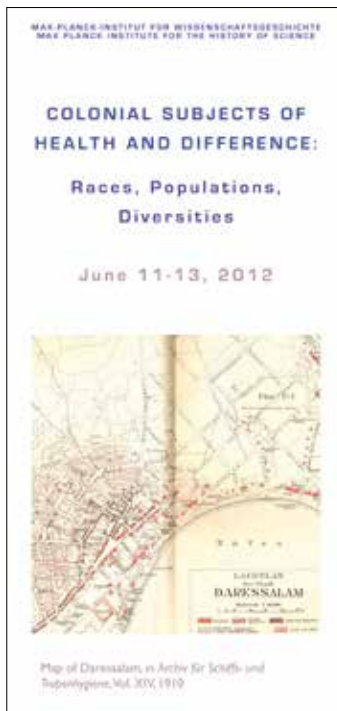

Workshop

Colonial Subjects of Health and Difference: Races, Populations, Diversities

June 11–13, 2012

ORGANIZERS *Alexandra Widmer* (MPIWG), *Veronika Lipphardt* (MPIWG)

KEYNOTE SPEAKER *Warwick Anderson* (University of Sydney, Australia)

This workshop focused on unexpected aspects of race concepts and human variation at the intersection of research and administration of health in colonial contexts. A central aim was to expand the current historiographical emphasis on race concepts in genetics and morphological features. With contributions on colonial contexts as diverse as Korea, Egypt, and Brazil, participants explored understandings of human variation in the management of labor, epidemics, and low fertility as it was entangled with research on nutrition, demography, and noncommunicable diseases.

Participants

- *Jean-Paul Bado* (Université de Provence, Aix en Provence, France)
- *Daniel Bendix* (University of Manchester, UK)
- *André Felipe Cândido da Silva* (Fundação Oswaldo Cruz, Rio de Janeiro, Brazil)
- Barbara M. Cooper (Rutgers University, USA)
- *Sarah Ehlers* (Humboldt-Universität zu Berlin, Germany)
- *Omnia El Shakry* (University of California, Davis, USA)
- *Maria Leticia Galluzzi Bizzo* (Universidade Federal do Rio de Janeiro, Brazil)
- *Antje Kühnast* (University of New South Wales, Australia)
- *Veronika Lipphardt* (MPIWG/Freie Universität Berlin, Germany)
- *Judith Littleton* (University of Auckland, New Zealand)
- *Carlos López Beltrán* (Universidad Nacional Autónoma de México)
- *Jin-kyung Park* (University of Toronto, Canada)
- *Julie Park* (University of Auckland, New Zealand)
- *Hans Pols* (University of Sydney, Australia)
- *Ricardo Ventura Santos* (Fundação Oswaldo Cruz/Universidade Federal do Rio de Janeiro, Brazil)
- *Katharina Schramm* (Martin-Luther-Universität, Halle-Wittenberg, Germany)
- *Alexandra Widmer* (MPIWG)

Minerva Gentner Symposium 2012

The Study of Jewish Biological Difference After 1945

October 15–17, 2012

ORGANIZERS *Veronika Lipphardt* (MPIWG/Freie Universität Berlin, Germany), *Amos Morris-Reich* (University of Haifa, Israel)

The study of Jews, contrary to common assumption, was not discontinued after World War II and the Shoah. The aim of this conference was to examine such studies in the context of deep transformations in the life sciences themselves, the radically altered political landscape, and the complex nexus between the two in the postwar period. Key questions included the following: How did postwar life scientists approach Jews as an object of empirical inquiry? How did they draw on or distance their work from earlier bodies of knowledge? Which disciplines and leading scientists were now involved, which no longer participated in such studies, and why?

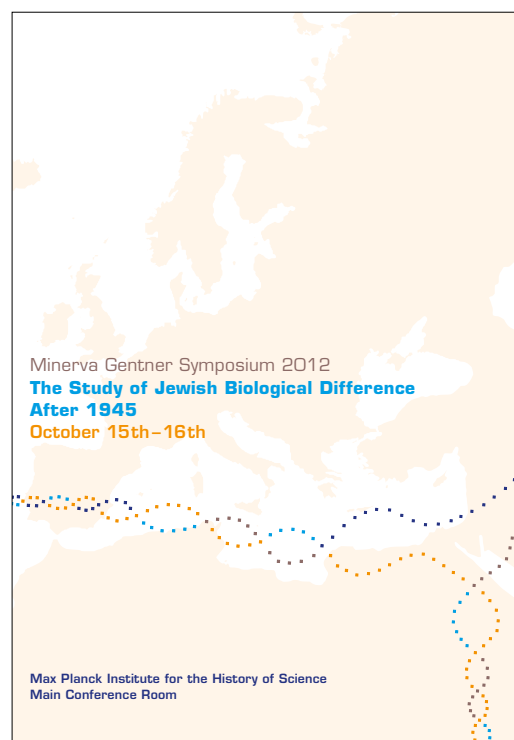

Participants

- *Anne Cottebrune* (Justus-Liebig-Universität Gießen, Germany)
- *Yulia Egorova* (Durham University, UK)
- *Raphael Falk* (Hebrew University Jerusalem, Israel)
- *Snait Gissis* (Tel Aviv University, Israel)
- *Petter Hellström* (Uppsala Universitet, Sweden)
- *Uwe Hoßfeld* (Friedrich-Schiller-Universität Jena, Germany)
- *Nurit Kirsh* (Bar-Ilan University, Ramat Gan, Israel)
- *Veronika Lipphardtíí* (MPIWG/Freie Universität Berlin, Germany)
- *Jonathan Marks* (University of North Carolina, Charlotte, USA)
- *Amos Morris-Reich* (University of Haifa, Israel)
- *Hans-Jörg Rheinberger* (MPIWG)
- *Alexander von Schwerin* (Technische Universität Braunschweig, Germany)
- *Amir Teicher* (Tel Aviv University, Israel)
- *Paul Weindling* (Oxford Brooks University, UK)
- *Felix Wiedemann* (Freie Universität Berlin, Germany)

Seminar Series

With a deliberately expansive scope, the seminar series included presentations by over forty scholars from all career stages, including those whose projects are described below in the guest section. Further presentations included the following:

Are You Really an Ape? The Scientific Construction of Ancestry

Jonathan Marks (University of North Carolina, Charlotte, USA)

Race, Politics, and Sexology in Magnus Hirschfeld's Encounter with India

Veronika Fuechtner (Dartmouth College, Hanover, USA)

Anthropology and the "New Systematics"

Lisa Gannett (Saint Mary's University, Halifax, Canada)

Genomic Re-figurings of Race and Nation in Latin America

Peter Wade (University of Manchester, UK)

Care/Souci/Pflege of the Data, Amazement, and the Impossible Sciences of GeneXEnvironment Interactions in Asthma (Promising Genomics V.2)

Mike Fortun (Rensselaer Polytechnic Institute, Troy, USA)

Bones, Words, and Archival Materialities of Race

Ricardo Roque (Universidade de Lisboa, Portugal)

Collaborations

All group members and the group as a whole engage in multiple collaborations with colleagues from renowned research institutions, and together contributed to workshops in Cambridge and Paris on “Making Human Heredity” and in Amsterdam on “Technologies of Belonging” (for further details, see the events section and individual reports). The section below highlights one ongoing collaboration.

Visualizations and Visibility

Analyzing scientists’ techniques of visualizing human diversity has been a central research focus of the group. Assuming that images in scientific fields are not mere ornaments of texts, nor simple illustrations of what is already textually explained, group members are interested in capturing the significance of images — as arguments in and of themselves — in the production of knowledge about human variation. In a joint workshop with Marianne Sommer’s research group “History Within” (University of Lucerne) in December 2011, different approaches and forms of visualization of human diversity and human origins were discussed, from photographs to genealogical trees to more abstract forms such as tables, diagrams, and graphs. The cooperation will be continued in the co-organized conference “Visibility Matters: Rendering Human Origins and Diversity in Space and Time,” to be held April 25–27, 2013, at the University of Lucerne. This conference will focus in particular on diagrammatic forms of representation that so far have received less scholarly attention than image-based visualizations.

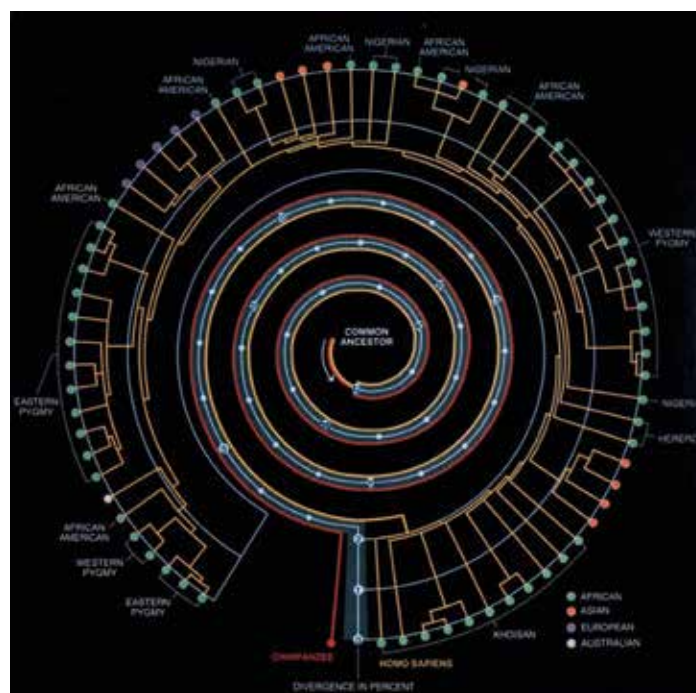

Representation of genetic distances between human populations, based on mtDNA-mutations, traced back to a common ancestor, and compared to a chimpanzee sample (red line). The image uses the long-standing division of humankind into four subgroups but also suggests intragroup variation. From Christopher B. Stringer. “The Emergence of Modern Humans.” *Scientific American* 263 (1990): 101. By permission of Ian Worpole.

The group’s database project “Visualizations of Human Diversity” collects graphical representations of human diversity from throughout the twentieth century. It provides a working tool for researchers interested in visualizations of human diversity and serves as a visual archive, making images accessible to scholars. It can be used to compare various images and to highlight similar aesthetics, and it can deliver insights into the history of certain forms of representation. The database collects images mainly from published works — textbooks, scientific journals, scientific monographs, and popularized science publications — but also from archival documents, scratch papers, and the Internet. The images can be randomly browsed, or they can be sorted under four different thematic subgroups: representations of human genealogies (e. g., family trees), maps, visualizations of human bodies, and more abstract graphical representations of diversity.

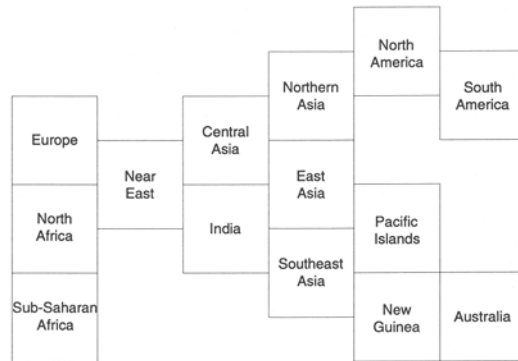

Abstract graphic representation of geographical distribution of allele frequencies for various genes. The first part lists allele frequencies in a highly schematized map of world regions. The second explains the underlying geographical scheme. Luigi Luca Cavalli-Sforza, Paolo Menozzi, and Alberto Piazza, *The History and Geography of Human Genes*. (Princeton: Princeton University Press, 1994): 126–7. By permission of Princeton University Press.



Guest Program

Selected Project Descriptions

Warwick Anderson (Research Fellow, University of Sydney, Australia)

Racial Laboratories and Reproductive Frontiers: The Twentieth-Century Sciences of Human Hybridity

This project reconstructs a previously unidentified transnational and transcolonial network of research on race mixing in the twentieth century—a global scientific debate on human segregation, assimilation, and absorption, involving human biologists, physical anthropologists, and sociologists. Between 1910 and 1940 there were more than twenty major scientific investigations of the effects of miscegenation in the Pacific, North America, Southeast Asia, South Africa, and the Maghreb. This study concentrates largely on the extensive and influential series of studies on race mixing organized by the Department of Anthropology at Harvard University, one of the major pre-World War II sites for the training of physical anthropologists. Through their studies of frontier biology, this network of Harvard anthropologists traced their “miscegenation map” of the new world.

The project examines the practices of scientific investigation in human biology and reconstructs the interactions that occurred in fieldwork. It follows scientists as they moved between, or made comparisons between, multiple sites. During the past twenty years, historians have attempted to “situate” scientific practice in specific social circumstances. But having thus situated science, how then does one account for its travel and stabilization in diverse locations? How did the character of the interactions between investigators and local inhabitants vary from place to place? How do practices and observations become commensurate and comparable at different sites? Through transnational studies such as this one, we will begin to understand how scientists can make global claims on bodies and their environments.



Warwick Anderson

Samuël Coghe (Predoctoral Fellow, European University Institute, Florence, Italy)

Population Politics in Tropical Africa: Knowledge, Health, and Colonial Rule in Portuguese Angola, 1900–1945

Drawing on Michel Foucault’s concept of a “biopolitics of the population,” this project examines how the African population in Portuguese Angola was conceptualized, counted, and governed by a vast array of colonial actors, most notably doctors, administrators, and missionaries. It traces how and why, in the first half of the twentieth century, colonial interventions to study the population and improve both its quantity and quality were inextricably linked with strong fears of depopulation and degeneration. The project thereby shows that notions of race and ethnicity pervaded colonial thinking about population, as they shaped ideas about disease, fertility, and mobility. In his research, Coghe also consistently compares Angola with other colonies and highlights often neglected transnational connections. This approach allows him to argue that Portuguese colonialism in Angola was firmly embedded in contemporary



Samuël Coghe

colonial practice in tropical Africa, rather than constituting an exception, as has often been claimed.



Joan H. Fujimura

Joan H. Fujimura (Visiting Scholar, University of Wisconsin-Madison, USA)

What Is Race in the Age of Genomics?

This project examines human post-genomic research and its emerging definitions of individual and population similarities and differences, with a focus on biomedical sciences in the United States. The new genomics promises a personalized medicine based on the individual's genetics. However, these projects have been accused of (re) introducing genetic notions of race. The project presents an archaeology of the tools and practices used in current genomic searches for disease-related genetic markers, through which genetic differences and similarities are produced. It has found that "race" and "population" are often confounded, though some of the new genomic technologies allow biomedical genetics research to be done without the use of racial categories. However, because the use of technologies cannot be controlled, some geneticists have used the new technologies to produce differences between individuals in particular nations, to classify and categorize them, and then to write histories of their origins. The last part of the project analyzes the ways in which scientists' categories differ from the ways differences have been discussed in race theory in the United States and asks whether and how post-genomic technologies may change discourses of race and race theory in the United States.



Pascal Germann

Pascal Germann (Predoctoral Fellow, Universität Zürich, Switzerland)

"Nature's Laboratories": Racial Research and Human Genetics in Switzerland, 1920–1970

This project investigates the entanglement of racial research and genetics in the twentieth century, using Switzerland as a case study. Between 1920 and 1970 there was a boom of heredity research at the population level in Switzerland. These research projects ranged from racial anthropological investigation to medical genetic fieldwork to projects with a population-genetics focus. In these data-driven surveys, genetic, eugenic, anthropological, and medical horizons of research were overlapped and intertwined in a wide variety of ways. The goal of this research project is to bring to the fore and examine such entanglements. The project explores the epistemic, social, and political conditions that allowed for the interconnections between heredity research and racial research. It also aims at scrutinizing the research fields in which racial categories and interpretations increasingly lost their significance.

The project examines the changing institutional, discursive, and political conditions which facilitated or hampered the production, circulation, and application of heredity and population knowledge. The project also focuses on the knowledge-generating practices themselves, retracing the paths from data mining to published facts. Germann thus assumes that racial and eugenic classifications won their persuasive power not only in social and political contexts but also in material practices and representations of scientific research.

Jonathan Harwood (Visiting Scholar, University of Manchester, UK)

Has Science Transformed Agriculture? Mendelism and Plant Breeding, 1900–1940

Scientists (and some historians of science) often have been wedded to the idea that technology is derived from the application of scientific knowledge. The earliest proponents of Mendelian genetics were no exception, stressing the importance of their field for plant breeding, and since then geneticists have returned to this theme from time to time. In this project, Harwood examines the claims made for Mendelism before World War II and assesses their validity against two benchmarks: the knowledge and experience of commercial breeders and of specialists in agricultural colleges and other public-sector institutions. He concludes that early claims that Mendelism would “revolutionize” breeding practice were little more than rhetoric and that even more limited and specific claims for its importance were unconvincing. Nevertheless, Mendelism did have an impact on breeding in three respects. It provided a theoretical foundation for breeding practice (i.e., a way to think and talk about it); it served a heuristic function, suggesting to breeders a new procedure with which varieties might be improved; and it provided a critique of existing practice, indicating which methods were more effective than others.



Jonathan Harwood

Ann M. Kakaliouras (Visiting Scholar, Whittier College, USA)

Contacting Difference: An Analysis of American Physical Anthropological Practice in “Indian Country” During the Early Twentieth Century

Broadly, this book project examines how American physical anthropology constructed and deployed its concept of the “Indian” during the twentieth century. One focus is the cultural and political work that early American physical anthropologists accomplished through their research as well as in their interactions with Native American people. From the 1910s through the 1930s, under the influence of the eugenics movement, physical anthropologists turned their professional expertise in anthropometry from identifying groups of Native physical “types” to plucking the supposedly few “full-bloods” from what they saw as an increasing sea of “mixed-blood” Indians. The study contends that this shift within American physical anthropology and researchers’ roles as professional experts encouraged the development of new “litmus test” techniques for the identification of “full-bloods,” in effect allowing them to abandon cultural and genealogical information as informative of racial status. In a few significant instances, the United States government employed physical anthropologists to assist in deciding land rights cases and in determining tribes’ eligibility for federal recognition as Indians. Using a close reading of anthropometric data associated with two federally funded studies, the project illustrates increasing physical anthropologists’ increasing confidence in their quantitative and qualitative methods.



Ann M.
Kakaliouras



Robert Meunier

Robert Meunier (Predoctoral Fellow, University of Exeter, UK)

Individuals and Types: From Constitutional Medicine to Personalized Medicine

This project investigates the concept of constitution in medical discourse in German-speaking countries from about 1890 to 1930. The term “constitution” was used to address differences in the somatic makeup of people that were thought to explain why individuals reacted differentially when exposed to pathogenic influences. Through an examination of the work of Friedrich Martius, Julius Bauer, and Theodor Brugsch, the study reconstructs the role of photographs, diagrams, anthropometric measurements, and typologies in shaping both the concept of constitution as mediating generalized medical knowledge and the evaluation of individual patients in explanation, diagnosis, prognosis, therapy, and prophylaxis. Contrary to most accounts, which emphasize the holistic criticism of scientific medicine, and the perceived “crisis of medicine” in Weimar Germany in particular, the study shows how constitutional medicine not only grew out of bacteriology and cellular pathology, but also aimed at complementing these research programs. Furthermore, its close relation to the emerging science of genetics is examined. Robert’s analysis of the epistemic tension between knowledge of types and knowledge of individuals around 1900 also informs the assessment of current personalized medicine.

Alondra Nelson (Visiting Scholar, Columbia University, USA)

The Social Life of DNA: Race and Reconciliation after the Genome

The use of DNA analysis has become widespread, and diverse aspirations, interests, and ends are now sought through it. The double-helix has wound its way into the nucleus of some of the most significant issues confronting American society. Undertakings that Nelson calls reconciliation projects have been central to this process. Set about at many sites — including courts of law, historical institutions, and activist campaigns — reconciliation projects are endeavors in which genetic analysis is used toward the end of community cohesion, collective memory, or social justice. These efforts include the uncovering of biographical or historical information that has been lost to the march of time through the aid of genetics. These projects also concern the adjudication and resolution of contentious issues so that reconciliation can subsequently be achieved.

This research project considers one particular stratum of this broader topography of reconciliation projects: How and why genetic insights are being applied to U.S. racial politics, particularly black cultural practices aimed at social reconciliation. Tracing several reconciliation projects, from their beginnings in the United States in the 1990s to their transnational expansion today, allows us to perceive how desires for reunion and recompense have impelled genetics beyond the small social world of the biomedical laboratory and into larger society.

Tino Plümecke (Predoctoral Fellow, Technische Universität Berlin, Germany)

Race in the Age of Genetics: The Order of People in the Life Sciences

Plümecke’s research focuses on the continued use and revival of race concepts in the life sciences in the last three decades. He analyzes processes in medicine, pharmacol-

ogy, forensics, and physical anthropology, and issues in applied genetics such as commercial ancestry tests and the Human Genome Diversity Project. The central question in this respect: How and why can race still be a productive concept in the contemporary life sciences? Despite declarations of the end of biological race concepts after World War II, the concept refuses to die. Instead, race concepts in the life sciences have mutated in the last few decades into new models under new paradigms of biological research and gained momentum in the age of genetics/genomics in processes of molecularization, medicalization, and the politics of integrationism. This project reconstructs the changing arguments, the role of critics, and the factors driving the ongoing reconstitution of new race concepts.

Joanna Radin (Predoctoral Fellow, University of Pennsylvania, USA)

Life on Ice: Frozen Blood and Biological Variation in a Genomic Age, 1950–2010

This project examines the history of human biologists' efforts to collect and freeze blood from a range of supposedly vanishing human communities. Radin situates these practices in the context of the International Biological Program, a large-scale effort to assess biological baselines in the Cold War era. She also devotes attention to these biologists' use of technologies of cold storage, including mechanical refrigeration, liquid nitrogen, and dry ice. Radin complements this historical research with ethnographic engagement in present-day laboratories that are involved in maintaining old frozen blood and defrosting it for new genomic uses.

In July 2012, Joanna Radin took up a position as Assistant Professor of History of Medicine and History at Yale University, USA.



Joanna Radin

Ricardo Ventura Santos (Visiting Scholar, Professor at Fundação Oswaldo Cruz/ Universidade Federal do Rio de Janeiro, Brazil)

Fruit Flies, Indians, and Mestizos: The Constitution of Human Population Genetics in Brazil after World War II (1950–1960)

In the period following World War II, a growing number of physical anthropologists and human geneticists started carrying out human biological variability studies in different parts of the world. These investigations were influenced by the consolidation of the “modern evolutionary synthesis” in the 1930s and 1940s. This project examines the emergence of human population genetics in Brazil in the second half of the twentieth century. A key event was the cooperation, funded by the Rockefeller Foundation, between Theodosius Dobzhansky of Columbia University and researchers of the University of São Paulo in the 1940s and 1950s. In the 1950s, a number of young geneticists trained in drosophila genetics turned to the field of human genetics. This research is based on the analysis of published papers, archival documents, and interviews with Brazilian and foreign geneticists who worked in Brazil in the mid-twentieth century. It focuses on two large-scale projects that involved Brazilian and North American geneticists (James Neel and Newton Morton): one on Amazonian indigenous populations and the other on mestizo populations in northeastern Brazil. This research is partially funded by the Brazilian Research Council and carried out in cooperation with the postdoctoral fellow Vanderlei Sebastião de Souza.



Ricardo Ventura Santos

Short-Term Pre- and Postdoctoral Fellows

- *Manuela Bauche* (Universität Leipzig, Germany): Science, Metropole, and Colony: The Medical Discourse on Malaria Between Germany and Africa, ca. 1880–1920
- *Sven Bergmann* (Humboldt-Universität zu Berlin, Germany): Resemblance That Matters: The (Re-)production of Pheno-Typologies in Transnational Anonymous Gamete Donation
- *Berit Bethke* (DFG-Graduiertenkolleg “Weltgesellschaft,” Universität Bielefeld, Germany): Universal Views in Local Settings: A Historical Case Study of Communication of (Bio-Medical) Body Knowledge by Exhibition of Health Education
- *Sarah Blacker* (University of Alberta, Canada): The Pharmacogenomic and Epidemiological Concepts of Human Genetic Variation in the Development of Personalized Medicine
- *Sophia Efstathiou* (University of Southampton, UK): Found Science: Using Race Concepts in Science
- *Andrew M. Fearnley* (Cambridge University, UK): Methods to Madness: Race, Knowledge and American Psychiatry, 1880–2000
- *Sebastián Gil-Riaño* (Victoria College, Canada): The Rise of Scientific Anti-Racism: A Historical Epistemology of UNESCO’s Campaign Against Racism, 1945–1978
- *Johanna Gonçalves Martín* (University of Cambridge, UK): Paths of Health: Gender and Reproductive Medicine Articulated Amongst Yanomami People and Doctors in Venezuela
- *Sofiya Grachova* (Harvard University, USA): The Politics of Jewish Life: Medicine and Jewish Politics in the Russian Empire and the USSR, 1881–1930
- *Oliver Hochadel* (Consejo Superior de Investigaciones Científicas, Spain): The Making of a Magic Mountain: Atapuerca, Spanish Paleoanthropology, and National Identity
- *Lara Keuck* (Johannes-Gutenberg-Universität Mainz, Germany): Of Human Families and Mutant Mice Strains: Transfer and Transformation of Knowledge about Alzheimer’s Disease in the early 1990s
- *Mike Laufenberg* (Technische Universität Berlin, Germany; funded by the Hans Böckler Stiftung): The Government of Sexuality: Subjectivity, Truth, and Power in the Age of Biology
- *Ageliki Lefkadiou* (Aristotle University of Thessaloniki, Greece): Reformulating Race: The Visualization of Human Diversity in Greek Primary School Science Textbooks
- *Thomas Mayer* (Universität Wien, Austria): Das Rassenbiologische Institut der Universität Wien, 1938–1945
- *Giuditta Parolini* (Università di Bologna, Italy): Statistics and Computing in Agriculture and Biology in Britain, 1920s–1960s
- *João Rangel de Almeida* (University of Edinburgh, UK): Empires of Health: Diplomats, Doctors, and the Standardisation of Epidemic Diseases, 1851–1911
- *Martina Schlünder* (Justus-Liebig-Universität Gießen, Germany): Populations and Persons in Biomedicine: Negotiating Difference in Clinical Practices
- *Alexander von Schwerin* (Technische Universität Braunschweig, Germany): Variability of Toxic Bodies





- *Fenneke Sysling* (University of Amsterdam, Netherlands): Disembodied and Re-embodied Knowledge: Physical Anthropology in the Netherlands Indies, ca. 1880–1960
- *Amir Teicher* (Tel Aviv University, Israel): Statistics on Mental Illnesses among Jews in Germany, Before and After 1945
- *Ana Carolina Vimieiro Gomes* (Universidade Federal de Minas Gerais, Brazil): Measuring and Classifying the Diversity of Human Bodily Features: Biotypology in Brazil, 1930–1950
- *Robert-Jan Wille* (Radboud University Nijmegen, Netherlands): The Interrelation Between Government Support of Biology, Academic Biological Thinking, and Colonial Governance of Europe
- *Christine Winter* (University of Queensland, Australia): Race Mixing and Aryan-Related Races from the Asia-Pacific: Continuities, Discontinuities, and Connections

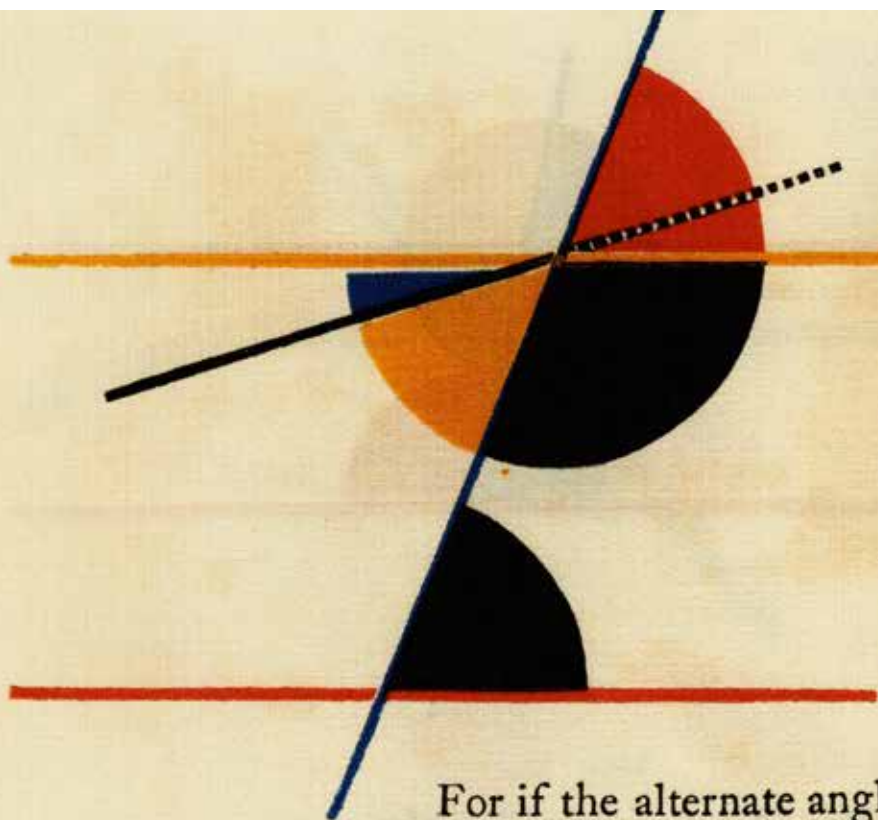

Short-Term Visiting Scholars





- *Eric Engstrom* (Humboldt-Universität zu Berlin, Germany): Emil Kraepelin's Research on Native and African American Psychiatric Patients and His Trip to the United States in 1925
- *Isabella Ferron* (Università Ca' Foscari, Italy): Wilhelm von Humboldt and Human Diversity
- *Alexa Geisthövel* (Institut für Geschichte der Medizin, Charité Berlin, Germany): Intelligenz und Rasse: Franz Boas' psychologischer Antirassismus zwischen Amerika und Deutschland, 1910–1940
- *Jeanne M. Haffner* (Harvard University, USA): Maladaptation: Visual Taxonomies of Human Habitation and Social Scientific Critiques of the Grands Ensembles in 1960s France
- *Axel C. Huentelmann* (Universität Bielefeld, Germany): Biologische Ökonomien: Eine Geschichte des Wachstums (ca. 1770–1970)
- *Brad Hume* (University of Dayton, USA): Studies in the Cultural History of Heredity
- *Martin Lücke* (Freie Universität Berlin, Germany): Wachstum: Eine Wissenskritik
- *Thomas Ross Miller* (New York University, USA): Corporealism: Sensory Classification, Embodied Knowledge, and the Origins of Anthropology
- *Amos Morris-Reich* (University of Haifa, Israel): Race and Humanism: The Epistemology of Arthur Ruppin
- *José Emmanuel Raymundo* (Tulane University, USA): Dangerous Bodies, Dangerous Cities
- *David Skinner* (Anglia Ruskin University, UK): Rethinking the Development of the “Database State”: The Relationship Between Technologies of Surveillance and Technologies of Transparency
- *Daniel J. Walther* (Wartburg College, USA): The Medicalization of German Colonialism: STDs, Colonial Physicians, and Indigenous Agency, 1884–1914





STRAIGHT line (—) falling on two parallel straight lines (— and —), makes the alternate angles equal to one another; and also the external equal to the internal and opposite angle on the same side; and the two internal angles on the same side together equal to two right angles.

For if the alternate angles  and  be not equal, draw —, making  =  (pr. 23).

Therefore  ||  (pr. 27.) and therefore two straight lines which intersect are parallel to the same straight line, which is impossible (ax. 12).

Hence the alternate angles  and  are not unequal, that is, they are equal:  =  (pr. 15);

∴  = , the external angle equal to th^e inter-

Max Planck Research Group

Modern Geometry and the Concept of Space

Director: *Vincenzo De Risi*

Introduction

The Max Planck Research Group on Modern Geometry and the Concept of Space was established in January 2011 under the direction of Vincenzo De Risi. The main research topic of the group concerns the birth of modern geometry as a theory of space in the eighteenth century, and extends to the scientific and philosophical development of the concept of space in the modern age.

Although a divide between ancient and modern geometry can be framed in different ways, the most useful approach may well be the emergence of the consideration of *space itself* as an object of *geometrical* investigation. Greek mathematics understood geometry as a study of straight lines, angles, circles, and planes, or in more general terms as a science of figures conceived against an amorphous background space whose definition lies outside the limits of the theory. This understanding was superseded by a conception of space itself (and spaces, now plural for the first time) endowed with geometrical properties. The main concern of this new geometrical science is to characterize the structures and features of geometrical space in axioms and demonstration. Although it is quite clear that this revolution in geometry helped shape the scientific world such that contemporary mathematics remains incomprehensible without it, the questions of *when*, *why*, and *how* this revolution took place are still to some extent obscure.

The earliest record of a geometrical understanding of space itself is probably to be found in some Renaissance treatises on perspective, and then in Pascal's pioneering studies on the geometry of projections. The first comprehensive and conscious attempt in a new science of space, however, appears in the hundreds of essays by Leibniz on the *analysis situs*, in which the philosopher tries to define space and its properties axiomatically, and to link Euclidean axioms to the very definition of space. A century and a half later, this geometrical understanding of space had become commonplace: non-Euclidean geometries and projective techniques form part of mainstream mathematical research, and a modern conception of space and spatial intuition has helped reshape pure and applied science, philosophy, and even the visual arts.

Against this background, the research group aims to reconstruct this 150-year-long mathematical, philosophical, scientific, and cultural revolution, from the time beginning of the ancient view of geometry as a science of figures and magnitudes began to fracture, to the flowering of a full-fledged expression of a genuine science of space. The main body of the research naturally focuses on the history of mathematics itself, as this history registers, year by year, the core developments in the field. The very nature of the investigation, however, encourages a more complex and structural approach, including, for example, an analysis of eighteenth-century developments toward a geometry of projections that may reveal how the idea of a plurality of spatial structures can be traced from the followers of Desargues to Monge and Poncelet. This approach is combined with parallel research into other interconnected fields whose development sheds light on the growth of mathematics, such as optics and the physiology of perception, as well as the philosophical debate about the theory of vision (in Berkeley or Reid, for instance) and the different *space-sensoria* in general (e. g., the quarrel about Molyneaux's case). A different line of research draws on the prehistory of non-Euclidean geometries in the eighteenth century (e. g., Saccheri or Lambert) and the beginnings of philosophic reflection on the topic (e. g., Reid, Lambert). It is also useful to explore the contribution made by the development of mechanics to the concept of space — in the Newton–Leibniz controversy and its consequences — and the effect of this new geometry on physics itself. Probably the last philosophically relevant contribution is Kant's famous synthesis of these debates in his writings about space and geometry. The generation of mathematicians after Kant already began working with the new geometry of space.

Among the activities of the research group was a very lively colloquia series, in which both MPIWG fellows and visiting scholars presented their current research in the history and epistemology of geometry. These meetings were very successful and attracted several other scholars and doctoral students from the major universities in Berlin. Among the invited visiting scholars who presented a paper and participated in the colloquia were Michael Friedman (Stanford University), Alison Laywine (McGill University), Andrew Arana (University of Illinois), Bernardo Mota (Universidade de Lisboa), Fabio Acerbi (CNRS, Lille), and Francesca Biagioli (Università di Milano). In the summer of 2011, the colloquia series was extended to become a biweekly workshop of the entire research group, with brainstorming sessions on the development of geometry in the early modern age, which proved very fruitful for shared work as well as for the individual research projects of the fellows involved.

The research group started a collaboration with the Scuola Normale Superiore in Pisa, which we hope will continue in the years to come. The main outcome of this collaboration was the joint organization of the conference “Space, Geometry, and the Imagination from Antiquity to the Modern Age,” which was held at the MPIWG in August 2012. The conference program sought to examine the connections between the philosophy of space and geometry from the beginnings of Greek mathematical research to the early modern outcomes of such research, and included lectures by Henry Mendell (California State University, Los Angeles), Alexander Jones (New York University), David Rabouin (CNRS, Paris), Franco Farinelli (Università di Bologna),

Gary Hatfield (University of Pennsylvania), Douglas Jesseph (University of South Florida), Andrew Janiak, (Duke University), Daniel Garber (Princeton University), Graciela De Pierris (Stanford University), Jeremy Gray (Open University), and Michael Friedman (Stanford University).

Individual Projects

Vincenzo De Risi (Research Group Director)

Historical Epistemology of Space and Geometry

Vincenzo De Risi is mainly working on a book project that describes the surfacing of a geometry of space from classical geometry. Although the central figures in this project are those philosophers and mathematicians in the eighteenth century who first envisaged the possibility of a geometry of space, De Risi's own interests also include the long-term development of the concept of a mathematical space. With respect to the latter, he is attempting to single out the most relevant scientific and philosophical episodes in ancient and modern times which represent the "prehistory" of the above-mentioned geometrical revolution: beginning with the Neoplatonic epistemology of late antiquity, which in the works of Proclus, Simplicius, and Philoponus foreshadows a new concept of space that will deeply influence discussions in early modern times (Piccolomini, Barozzi, Pereira); to the developments of medieval mathematics (especially in Islamic countries), which introduced very subtle arguments about the use of motion in geometric space, which would be further discussed in the Euclidean commentaries of the Renaissance (Clavius, Peletier); and the new naturalistic philosophy of the Renaissance, which in the works of Francesco Patrizi and Tommaso Campanella led to a (still naive and tentative) geometry of space, which, in turn, was developed mathematically by Giambattista Benedetti or Giovanni Alfonso Borelli.

Vincenzo De Risi's ongoing research on the geometrical epistemology of the modern age mostly focuses on Leibniz's geometrical studies and their influence on the eighteenth century, as well as on Kant's philosophy of space and mathematics. He is also working on the beginnings of non-Euclidean geometries and has published an annotated edition of Saccheri's *Euclides vindicatus* in Italian, which is currently being translated into English (to be published by Springer). He is preparing a similar edition in English of Lambert's *Theorie der Parallellinien* (also for Springer). De Risi is also editing the proceedings of the 2012 conference on space and geometry (to be published by Birkhäuser).



Vincenzo De Risi

Portrait of G. W. Leibniz, by Johann Friedrich Wentzel d.Ä., around 1700. Archive of the Berlin-Brandenburg Academy of Sciences and Humanities, Photo Wikimedia Commons





Angela Axworthy

Angela Axworthy (Postdoctoral Research Fellow)

The Ontological Status of Geometrical Objects in the Commentary on the Elements of Euclid of Jacques Peletier du Mans (1517–1582)

In this project on the ontological status of geometrical objects in Jacques Peletier du Mans' commentary on Euclid's *Elements*, Angela Axworthy is studying the conceptions of this sixteenth-century French mathematician (1517–1582), who played an important role in the early modern controversy on the status of the angle of contact, and on the nature, the causes, and the mode of existence of Euclidean geometrical objects. These questions, which are among the key issues of the premodern philosophy of mathematics, emerge in Jacques Peletier's commentary on the *Elements* (published in 1557) mainly in the context of his discussions of the angle of contact, of the superposition of figures, and of the notions of point, line, and surface. These commentaries offer certain conceptions about geometrical essences, their relation to nature, and their mode of apprehension, which can be considered philosophically rich and, to a certain extent, original. Axworthy's study of this commentary aims not only to determine Peletier's conceptions of the nature, the level of reality, and the modes of perception of geometrical objects, but also to investigate the interrelations which may be found in this context between the epistemological discourse and the practice of the geometer.



Delphine Bellis

Delphine Bellis (Postdoctoral Research Fellow)

The Emergence of a Natural Geometry of Vision from Ptolemy to Kepler and Descartes



Portrait of Luca Pacioli with Nobleman by Jacopo de' Barbari, 1495. Galleria Nazionale di Capodimonte, Naples, Italy. Photo: Wikimedia Commons

The aim of Delphine Bellis's research was to evaluate how early modern optics attempted to deal with the visual perception of spatial depth in comparison with the solutions provided by ancient and medieval optics. Bellis mainly focused on the notion of a natural geometry of vision as it was devised by Kepler and taken up by Descartes. Whereas Kepler applied this psychological procedure to the mental perception of reflected and refracted images, Descartes relied on it to account for the evaluation by sight of the distance at which bodies are situated in space. As a result, Descartes used an element of Kepler's optics to produce an epistemological reversal of the cognitive reliability of vision. An article on this topic will be submitted in March 2013 for publication in a volume edited by Jonathan Regier and Koen Vermeir (to be published by Springer).

As of September 2011, Delphine Bellis has been a postdoctoral researcher in the Department of Philosophy and Moral Sciences at the University of Ghent in Belgium.

Henny Blomme (Postdoctoral Research Fellow)

Space As Some Kind of Nothing

Henny Blomme worked as a postdoctoral fellow in the Research Group on Modern Geometry and the Concept of Space. His research focuses on the problematic status of space in modern philosophy. During his stay at the MPIWG, he concentrated on the paradox nature of space in the philosophy of Immanuel Kant.

In the work of Kant, space is, as the purely subjective form of outer intuition, an *ens imaginarium*, which means that it is some kind of nothing. But the claim that space is such a form is absent from Kant's own analysis of our concept of space. Indeed, the metaphysical exposition only shows that space must be an a priori intuition. It thus seems that Kant had to provide an interpretation of the result of the exposition in order to give it a consistent place in his theoretical philosophy.

What, then, is Kant's argument when he claims, on the basis that we represent space as an a priori intuition, that space must originally be a purely subjective form? And does this argument exclude any other interpretation of the conclusion of the metaphysical exposition? Some of the results of Blomme's research are to be found in the following publications: "Können wir den ursprünglichen Raum erkennen?" (forthcoming) and "The Completeness of Kant's Metaphysical Exposition of Space" (published in the 2012 issue of *Kant-Studien*).



Henny Blomme



Immanuel Kant, 1724–1804
Popular Science Monthly 1903/04



Davide Crippa

Davide Crippa (Predoctoral Fellow)

Revisiting the Distinction between Geometrical and Mechanical Curves in Early Modern Geometry

The aim of Davide Crippa's project in the Research Group on Modern Geometry and the Concept of Space is to elucidate the fundamental boundary between geometrical and mechanical curves analyzed in Descartes' *Géométrie* (1637), and afterwards crucially reshaped by Huygens and Leibniz. This project also includes the study of new unpublished material on Leibniz's treatment of rolling curves.

Huygens and Leibniz provided two partially different interpretations of the Cartesian distinction, not fully studied, whose understanding may allow us to uncover a new

pattern of influence of Cartesianism (e.g., To what extent is Cartesian symbolism applicable to segments, areas, and arc lengths?), as well as respond to broad philosophical questions, such as how mathematical objects are represented at a given historical moment, and to what extent a representation is considered more adequate than another. Crippa holds that the distinction has not only a mathematical, but also an epistemological import, as it concerns two different epistemic modes, or attitudes, with respect to the acquaintance with geometrical objects.



René Descartes, 1596–1650
Portrait by Jan Baptist Weenix ca. 1648,
Central Museum Utrecht



Valérie Debuiche

Valérie Debuiche (Postdoctoral Research Fellow)

Leibniz and the Invention of the *Calculus Situs*: Desargues' and Pascal's Influence

Valérie Debuiche's project examined the origin of Leibniz's invention of a new kind of geometry, called the "geometric characteristic," which was devoted to spatial relations and not to figures or quantities, but which nonetheless was endowed with a symbolism and a combinatorial calculus: a general science of space which renewed the geometric science of the seventeenth century. As revealed in the first texts on the geometric characteristic, its origin seems to be related to Leibniz's knowledge of Desargues' and Pascal's contemporary perspective geometries of conics. Valérie Debuiche's goal was to determine the nature and the strength of this relation. Was the geometric characteristic inspired by Leibniz's reading of Arguesian theories and Pascal's manuscripts? Or was it a totally innovative geometry, devoid of any real influence? In fact, Leibniz's usual originality was still in evidence despite the similarity between his new conception of space as a pure and complete *extensum* and the perspective notion of space as a structure. Moreover, both geometries were based on perception and, as

such, could be considered from a philosophical point of view, so that Debuiche's work has paved the way to the new issue of the relationship between Leibniz's philosophical conception of space, his use of the perspective model in his metaphysics, and the role of "relations" in his doctrine.

While at the MPIWG, Valérie Debuiche worked on two papers: "Perspective in Leibniz's Invention of *Characteristica Geometrica*: The Problem of Desargues' Influence," submitted to *Historia Mathematica* and currently under review; and "Pascal and Leibniz: Space, Situation, and Perspective," in preparation.



Blaise Pascal, 1623–1662
Gallery of Portraits, London 1833

Christian Leduc (Postdoctoral Research Fellow)

Methodology in Leibniz and the German Enlightenment



Christian Leduc worked on this project, which was part of Vincenzo De Risi's research group on geometry and space in the modern period. During his stay at the MPIWG, he completed two papers. The first is on Johann Heinrich Lambert and the experimental method. Lambert's contribution to eighteenth-century methodology consists in applying the deductive processes of analysis and synthesis to empirical notions and propositions. The synthetic operation is particularly interesting because it involves the use of hypotheses. The second

article concerns imagination and reason in Leibniz. For Leibniz, many fields of learning imply the use of imagination as a complementary tool to reason, in particular empirical sciences and geometry. Both of these works were presented to the research group members and highly benefited from the discussions that followed.

Johann Heinrich Lambert, 1728–1777
Lithography by Godefroy Engelmann

David Marshall Miller (Postdoctoral Research Fellow)

From Centers to Lines: The Spatial Frameworks of Early Modern Physics

David Marshall Miller's scholarship intersects philosophy of science and the history of early modern philosophy. He has been investigating how the rectilinear Newtonian universe superseded the spherical Aristotelian cosmos during the Scientific Revolution. This research focuses on representations of space — the conceptual frameworks by which spatial phenomena are described. In the physical sciences, representations of space determine what counts as "simple" spatial magnitudes and, in turn, the nature of bodies and motion. Miller has been preparing a monograph on the history of representations of space from Copernicus to Newton, showing how new representations of space enabled central achievements of early modern science: rectilinear inertia, universal gravitation, and collision mechanics. At the MPIWG, Miller completed



David Marshall
Miller

a chapter on Galileo's introduction of rectilinear inertia, and gathered material for a chapter on Descartes. Cooperation with the Working Group was incredibly helpful, uncovering important commentaries by Fermat and Roberval. Currently, Miller is an assistant professor of philosophy at Oxford College of Emory University.

John Mumma (Postdoctoral Research Fellow)

Concrete Figures and Abstract Spaces: The Differing Conceptions of Geometry in Berkeley and Reid

This project seeks to illuminate the underlying conception of geometry in George Berkeley's *A New Theory of Vision* and Thomas Reid's *An Inquiry into the Human Mind on the Principles of Common Sense*, on the nature of vision. In the early modern period Geometry was in a transitional phase, moving from its classical conception as a theory of idealized spatial objects to its modern conception as a theory of spaces. Though Berkeley and Reid were not primarily concerned with geometry, the tension between the classical and modern viewpoints can be seen in their investigations into the nature of vision. A prominent question for both was whether the objects of

vision are amenable to geometric treatment. Berkeley's verdict was negative. In the face of this answer, Reid sought to provide a positive one, and in so doing developed a non-Euclidean geometry for visual space. Mumma's research focuses on how assumptions about the subject matter of geometry with respect to the spatial figure/space contrast informed both answers. Since September 2012, Mumma has held an assistant professor of philosophy position at California State University of San Bernardino.

C. Herlinus, K. Dasypodius, *Analyseis geometricae sex librorum Euclidis*, Strasbourg 1566.



Marius Stan (Postdoctoral Research Fellow)

Philosophical Foundations of Physics in Kant and His Predecessors

Marius Stan is working on the conceptual foundations of classical mechanics. In particular, he is studying how early modern figures sought to connect their respective theories of mechanics with metaphysical doctrines about space and its structures, kinematic and dynamical. In the context of this broader enterprise, in the summer of 2011 he researched how these foundational issues of physics played out in post-Leibnizian Germany. More precisely, Stan investigated attempts by Christian Wolff and his followers to account for the Law of Inertia by means of purely relationist resources—that is, by sole appeal to metric relations between material particles. Second, Stan documented, and sought to explain, the cool reception of Newton’s absolute space in Enlightenment Germany, and the pro-Newtonian backlash that it generated among opponents of Leibniz on the Continent. Stan’s fellowship at the MPIWG enabled him to connect his investigations with those of Vincenzo De Risi’s research group Modern Geometry and the Concept of Space, and to receive very useful advice and feedback from the wider research community at the institute. As a result, he has been able to turn his research into two papers: “Newton and Wolff” (published in the *Southern Journal for Philosophy*, September 2012) and “Kant’s Phenomenology and Newtonianism” (forthcoming in *Oxford Studies in Early Modern Philosophy*, vol. 8, 2013).



Portrait of Sir Isaac Newton, by Godfrey Kneller, 1702. National Portrait Gallery, London, Photo Wikimedia Commons

*Mouvements de la bouche pour prononcer
la phrase: "Je vous aime"*
L'illustration, November 21, 1891
(no. 2543, title page)



Max Planck Research Group

The Construction of Norms in 17th- to 19th-Century Europe and the United States

Director: *Sabine Arnaud*

Introduction

This research group investigates the emergence of norms of the human by examining two exemplary constructions, hysteria and deafness, a pathology and a disability, from the beginning of the seventeenth century to World War I. By tracking the emergence of categories, their uses, and their circulation across texts, the project intends to establish how various human sciences created and identified a problem and invested in specific understandings of it. The project explores how political and epistemological stakes led to a constantly redefined set of associations and connotations.

The selection of a medical category, hysteria, allows the research group to trace the invention of a term, from its first use to its establishment in reference works, and the role of writing in that process. We examine the construction of a relationship between pathology and class, pathology and sexual difference, and pathology and literary references. The theme of deafness widens this approach, as its conceptualization involved a broad range of categories (deafness, deaf-speaking, deaf-blind, handicap, mental retardation) and disciplines (medicine, pedagogy, psychiatry, linguistics, law, and more). During the first phase (2011–2012), the focus of the deafness subproject was narrowed to nineteenth-century medical, pedagogical, and legal conceptions.

The project aims to show that norms are not a set of predefined ideas about the human but rather the result of available competences and of human sciences in the making. Whereas norms are most often presented in terms of an average or an ideal, in our research they are understood to be products of a struggle for authority. Rather than being a frame of intelligibility, norms result from a hierarchy between disciplines and from those disciplines' relationships to their objects.

Individual Projects



Sabine Arnaud

Sabine Arnaud

The Writing of the Category of Hysteria (1670–1820)

Sabine Arnaud's inquiry focuses first on the invention of hysteria in the course of the seventeenth to the early nineteenth century. Tracing the transformations of the category during this period and asking what was at stake in writing the diagnosis, the study makes three innovative contributions. First, Arnaud's analysis of this category focuses on a period largely ignored by scholarship up to now, 1670–1820, and addresses the dissemination of diagnoses that would later be associated with hysteria. It measures the rupture in the enunciation of knowledge that was produced by the appearance of the term "hysteria"—a category invented in the eighteenth century, and not by Hippocrates—and asks how specific meanings were created in this process and to what ends. It emerges that conceptions of convulsions in a religious context made up only a very small part of writings on hysteric pathology, which was also widely discussed in medical contexts and was a common reference in literature, public political debates, and even philosophical writings. Men and women of letters used the description of vaporous fits to exemplify the relationship between body and mind beyond strictly medical concerns. Works by Lennox, Carracioli, Diderot, Paumerelle, Chassaingon, and Godwin present narratives on physiological phenomena alternately appearing as a code, a truth, or a manipulation, depending on specific narrative demands. Another finding is that hysteria was not seen as a female malady in this period; it took shape as an aristocratic pathology until the French Revolution, when physicians started instead to present it as an illness of women across class boundaries.

Second, as a study of the genealogy of a medical category, this work enhances understanding of the development of a discipline, considering how the role and status of medicine became established in society during the late eighteenth century. Unlike existing studies of this development, which have focused on institutions or on the medical gaze, Arnaud's study addresses the emergence of a new image of the physician-courtier and the later transition from a doctor attempting to emulate aristocratic ways of life to a doctor-citizen. With the new focus on the health of the nation's body after the French Revolution, the stakes of hysteric illness shifted: it was no longer a diagnosis belonging to the upper classes, but facilitated a medical discourse on women and their responsibilities—thereby helping to establish the public role of medicine.

Third, the project proposes new methodological approaches, addressing the format and rhetorical strategies used to present the category as opposed to describing its successive definitions and interpretations. For example, Sabine Arnaud examines how, faced with the inadequacy of definitions, physicians characterized the pathology through metaphors; references to Plato's *Timaeus* and to a shared repertoire of images such as the chameleon or the Hydra created continuity among texts from 1575 to 1820 despite their divergent standpoints. She focuses on political and epistemological investments in the category and the constant transformation of its connotations and implications. Arnaud also analyzes manuscript reports to the Société Royale de Médecine and observations published in medical treatises. With its spectacular

symptoms, hysteria was often presented as a fascinating or bewildering pathology; other writers used it to think about their patients' reactions to the pathology and to their doctors. A wide range of literary genres were, furthermore, deployed by physicians to present the pathology to a lettered and aristocratic audience. Dialogues, autobiography, epistolary treatises, consultation by correspondence, and anecdotes articulated medical knowledge in the period. By attending carefully to writing and rhetorical strategies, webs of citation, and circulation, the project presents a history of science as a history of knowledge in the making.

The results of this research led to a monograph, to be published by Editions des Hautes Ecoles des Sciences Sociales in late 2013 or early 2014. A shortened version in English is currently under review at a U.S. academic press.

Sabine Arnaud

**The Construction of Deafness in Western Europe and the United States
(17th to 19th Centuries)**



L'opinion, August 22, 1924 (p. 15).

In the first phase of this subproject, Sabine Arnaud focused on nineteenth-century France and Italy. She investigated how deafness was typically constructed as a problem to be solved by disciplines such as pedagogy, otology, physiology, psychology, and constitutional law. All of these fields appropriated the question of deafness and claimed to find answers to this “problem” in an effort to establish their spheres of influence and authority. In the process, each created an understanding of deafness to which its own response would be the most appropriate.

The definition of deafness and that of abnormality were the object of constantly re-worked criteria that served to establish the expertise of the human science in question



Saunders Anatomy of the Human Ear 1817 (Plate I)

and to mark its frontiers. The project claims that disciplines did not so much define themselves with respect to deaf people as define themselves in relation to each other, through the redistribution, absorption, and redefinition of their expertise. The relationship between the human sciences regarding deafness was one of power; a discipline's influence was the outcome of its relationships with others, of its capacity to absorb other disciplines and speak for them. Setting norms of the human allowed doctors and educationists to claim universal and multipurpose knowledge.

Two tendencies in these processes have been identified: on the one hand, there were not only disseminations of terminologies but also ruptures, not only coincidences of practices but also forms of differentiation between disciplines in the construction of deafness; on the other, many major theorists in the late nineteenth century privileged a strategy of absorbing other disciplines rather than a strategy of specialization. But across disciplines and disciplinary conflicts, deafness offered an opportunity to assert over and over again that the mastery and particular use of language were key to thinking the limits of the human.

Sabine Arnaud has also collected a comprehensive bibliography of over four thousand Latin, French, German, English, Italian, and Spanish primary sources on deafness published between 1540 and 1914 which are located in different specialized libraries. In collaboration with the library of the Institut National des Sourds-Muets in Paris, she has digitalized a selection of sign-language alphabets.

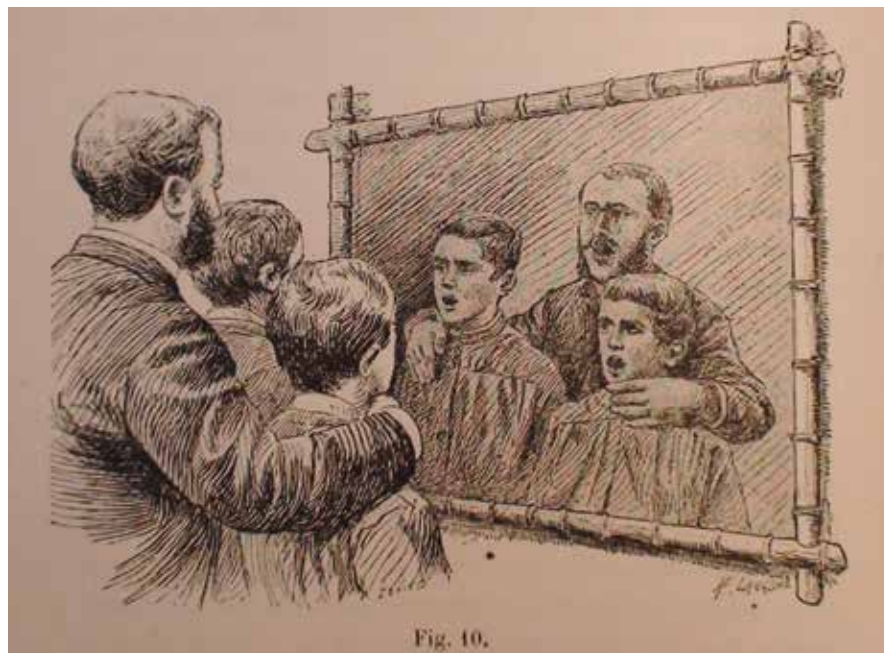

Ludovic Goguillot, *Comment on fait parler les sourds-muets* (p. 106).

Anja Werner

Deaf Education As Reflected in Nineteenth-Century Newspapers and Journals

In the course of the nineteenth century, a fundamental shift occurred in Deaf education. Whereas in the early 1800s teachers of Deaf people had applied manual methods such as national signed languages, finger-spelling, and signed vocal languages (also known as the “French” method), by mid-century they were increasingly promoting oralism — that is, teaching the Deaf articulation and lip-reading (the “German” system). The latter eventually became the dominant educational model, as a result of which most Deaf teachers were replaced by hearing oralists. The shift signified a reinterpretation of deafness as a medical condition rather than a cultural variety. Instead of aiming to teach the Deaf a concept of language, oralists promoted speech training. The Deaf would appear to be hearing, but they would actually be cut off from communication as a means of conveying knowledge. “Deaf” with a capital D refers to sign language–using Deaf people; “deaf” with a small d refers to hearing-impaired persons who do not use a signed language.

Drawing from her analysis of contemporary American, British, and German journals, Anja Werner focuses on the controversy between the two competing systems, as well as combined and alternative models of Deaf education such as the teaching of writing. She traces the public discourse by examining what exactly hearing philanthropists, doctors, and educators meant by “sign language” and “articulation,” and juxtaposes their views with those of Deaf thinkers. In doing so, she interprets the shift in educational priorities as a response to society’s understanding of “normal” communication.

In fact, the hearing majority’s ideas about the Deaf did not change as fundamentally as did hearing educators’ ideas about how to teach them. The problem was a failure to communicate: the pure oralists — those who favored teaching Deaf people without resorting to signed languages or manual alphabets at all — ignored the multifaceted information that Deaf people and moderate hearing educators provided. Instead of engaging in actual debates, pure oralists increasingly controlled the message, one that they justified with their supposedly scientific approach. In 1880, during the infamous Second International Congress on Education of the Deaf in Milan, hearing instructors voted to make oralism the only teaching method. Yet even today, the results of oralism have never been studied systematically— as Deaf activist and scholar Paddy Ladd has pointed out, its failures are blamed on an “unintelligent Deaf being.”

Whereas Anglo-American perspectives on Deaf history have been researched extensively, there are few historical studies on the German impact on Deaf education in the English-speaking Western world. Neither has Deaf history within Germany itself been studied comprehensively, despite the fact that, for nearly two centuries, German educational concepts have had a strong impact on Deaf education far beyond Germany’s borders. German physicians, educationists, and sociologists have carried out most of the research on Deaf culture, including historical considerations; historians have avoided the subject, thus also reinforcing old stereotypes of Deaf people as “incomplete” hearing persons.

Support for the “medical interpretation” of deafness as merely a defective sense in need of treatment was rooted in an enthusiasm for scientific method, which, in turn, was embodied both in German teaching traditions and in Germany’s leading



Anja Werner

scientific role in the late nineteenth century: the increased interest in articulation corresponded with the heyday and popularity of science “made in Germany.” Nationalism also played a role — as one supporter of signed languages, Johann Heidsiek of the Taubstummenanstalt in Breslau, explained, the Germans pursued oralism so adamantly that it was unthinkable for them to apply a “French” method. The hearing public in the United States and Britain, however, tended to overlook German supporters of signed languages, likely because such thinkers were boycotted by the German scientific press.

The changing priorities in Deaf education give insights into the changing value and understanding of “science” as an abstract idea among the wider public and its effects on specific sections of the population. Oralists were successful because of what one scholar has termed the “evangelical” fervor with which they pursued their objective. In fact, some seemed driven by a fear of a “deaf variety of the human race” (Alexander Graham Bell) taking over from the hearing establishment, a fear that reflected contemporary fears of “Others” such as Africans.



Raluca Enescu

Raluca Enescu

The Legal Capacity of the Deaf in the Decisions of the Imperial Court of Justice

This project analyzes decisions involving deaf people in civil and criminal cases in Germany between 1879 and World War I, the first period of activity of the Reichsgericht (Imperial Court of Justice). The Court was the highest civil and criminal authority in the German Empire, using a common Criminal Code passed in 1871 and the unified Civil Code of 1900, which contained provisions on the deaf in the areas of contractual obligations, family law, and inheritance law. The Court’s main role was to

unify the legal practice within the 27 territories of the newly unified German Empire. Twelve court case decisions relating to deaf people provide insights into the motives of the Court. The judges’ argumentations reveal medical, philosophical, and educational concerns, and their decisions articulate their understanding of deaf people’s legal capacity. The limitation of the role of deaf people in the judicial system shows how the law contributes to shaping society’s definitions of the “normal” citizen granted full legal capacity, and allows us to examine which cultural norms interact with court cases to produce the legal role of deaf people.



Entscheidungen des Rechtgerichts.

Events Organized

Lecture

Electro-otiatrics: From Medical Electricity to the Brain-Machine Interface

June 6, 2012

Mara Mills (New York University)

Mara Mills's lecture analyzed the shift from the model of "medical electricity" to that of "information transmission" in the history of electro-otiatrics. The paper surveyed experimental treatments and auto-experiments in electro-otiatrics by researchers in Europe and the United States between 1748 and 1950. Contrary to the classic narrative of medicalization, electro-otiatrics was often practiced by researchers from non-medical backgrounds, who were likely to conceive of electrical stimulation as a new medium rather than a normalizing therapy. At the same time, the violent history of electro-otiatrics as a treatment for deafness set the terms by which cochlear implants would initially be received.

Workshop

Constructing Norms and Disputing the Boundaries of Expertise: Interrogating the Legacy of Georges Canguilhem and Michel Foucault

October 30, 2012

Jean-François Braunstein (Université de la Sorbonne, Paris I)

Canguilhem before Canguilhem

Georges Canguilhem wrote several papers and a book before publishing his 1943 *Essai sur quelques problèmes concernant le normal et le pathologique*. In them, he takes inspiration from the philosopher Alain to suggest a philosophy based on a rebellion against "fact worshipping"; he uses Henri Bergson's thinking to reflect on the place of technique in life and elaborates a philosophy of his own on technique and creation. These early insights reappear in Canguilhem's later work on the history of science, and may lead to a clearer understanding of his critique of psychology, his deep interest in medicine, and his passionate denial of a deterministic view of the environment.



Peter Cryle (University of Queensland, Australia)

The Normative and the Normal in Nineteenth-Century French Biomedical Thinking: Rereading Canguilhem

Canguilhem's *Le Normal et le pathologique* (1943) tends to be read as an account of how medical writers put forward definitions of health and pathology which are grounded in rudimentary statistical thinking. The normal for those writers, according to Canguilhem, was something like an average physiological condition, and the abnormal was defined with respect to it, as a deficit or an excess. But that interpretation may be misleading. For Canguilhem, normativity is a property of life itself, the one whereby organisms tend to adapt the environment around them. It seems appropriate to re-examine Canguilhem's work in view of what it might offer for a modern, historically conscious revision of the notions of normal and normative.

Sabine Arnaud (MPIWG, Berlin)

Disciplinary Conflicts and the Distribution of Competence: Deafness between 1860 and 1900

This paper traced the emergence of the concept of abnormality in the corpus on deafness from 1860 to 1900 by examining the struggles between disciplines and the role of those struggles in shaping both the roles of medicine and pedagogy and their objects of study. It showed how the definition of deafness and that of abnormality were the objects of constantly reworked criteria that served to establish the expertise of pedagogy and medicine and mark the frontiers of their authority to teach the deaf to speak.

Todd Meyers (Wayne State University, Detroit)

Between Experimentation and Therapeutics: Kurt Goldstein's Thought, Including Its Interpretation by Georges Canguilhem and Others

Four recently restored research films that Goldstein made between 1929 and 1945 show him applying a fastidious and systematic approach to research on motor and sensory function disorders after brain lesion and non-lesion injuries, while maintaining close attention to therapy. The range of functioning demonstrated by his patients provided Goldstein with a place to begin his understanding—and arguably, his patients' understandings—of newly arrived-at individual norms that did not erase the categorical definition of disorder, but remade these definitions along an axis of individual experience.

Alessandro Bosetti (Berlin)

Il Fiore della Bocca (text-sound composition)

Produced in 2003 for the sound art department of DeutschlandRadio, "Il Fiore della Bocca" is composed exclusively from the voices of people in a condition of physical and/or intellectual disability, displaying the full range of musical possibilities of the spoken voice. A long series of conversations, in which spastic, aphasic, and larynxless people are confronted with examples of "deconstructed voice" in the tradition of experimental music and sound poetry, was the core of a two-year relationship with the speakers and the starting point of the composition.

International Conference

Deaf World/Hearing World: Spaces, Techniques, and Things in Culture and History

December 10–11, 2012

Organized with Lennard Davis, in cooperation with the University of Illinois, Chicago, College of Liberal Arts and Sciences, Department of English, and Department of Disability and Human Development

Held in English, German Sign Language, and American Sign Language

The conference focused on the history of deafness as an exemplary model of a community's mobilization for recognition of a cultural identity across the last four centuries. It gathered signing and speaking scholars from Europe, Canada, and the United States to discuss diverging constructions of deafness, some making of it a cultural identity and others a disability. Topics included the use of objects and technologies to create a space of encounter, and conceptions of the relationship between humans and language, the use of sign language and thought, and language and society across time and space.



David Ryckaert III, "The Pigment Grinder,"
(detail) 1635-8, City Heritage Museum
"Schabbelhau," Wismar, Inv. Nr. 7216 BR



Max Planck Research Group

Art and Knowledge in Pre-modern Europe

Director: *Sven Dupré*

Introduction

The production of objects of art involves diverse fields of knowledge, from history to theology, from knowledge of materials and techniques to mathematics, from natural history to anatomy, from optics to alchemy. Artists invented and appropriated knowledge, conceived and categorized knowledge, and transmitted and circulated knowledge in the visual and decorative arts in the pre-modern period. Did they distinguish artists' knowledge from other types of knowledge? And if so, what kind of knowledge did they consider within their remit? In short, what is artists' knowledge, and how did the epistemic requirements for artists change between 1350 and 1750?

This research group, which started on October 1, 2011, is writing an epistemic history of art that focuses on the mediation of the circulation of knowledge within the artists' workshop and beyond as it traveled in other domains more familiar to historians of science, medicine, and technology. By focusing on the epistemic dimensions of the production and consumption of art, this project opens up new ways to address the intermingling of the visual and decorative arts and early modern science. The projects deal with written, visual, and material transmission across different fields of knowledge.

Both the visual and the decorative arts are encompassed in an approach that deals with material objects, paintings, and other visual depictions primarily as *processes* rather than images. The study of the sources requires expertise in different domains, such as technical art history, history of science and technology, history of art, and art theory. The individual and collaborative projects of the research group mirror this cross-disciplinary diversity, as do the interests and qualifications of the members and guests. The group has been especially successful in attracting and integrating technical art historians with expertise in conservation science and art technological source research, whose work previously remained at the margins (at best) of the history of science and art history.

Written Transmission: Artists' Recipes and Books

This project studies written transmission. Traditionally considered congruent with the intellectualization of the artist's profession, the project looks closely at artists as readers and writers, and examines the role of reading in artists' appropriation of knowledge and the role of written knowledge in the production of works of art. The project considers two types of materials: recipes and books.

Database Project "Colour conText": Artists' Recipes from Cennini to De Mayerne

COORDINATION *Sylvie Neven, Sven Dupré, Karin Leonhard*

Knowledge of artists' materials and their preparation and manipulation was transmitted in collections of recipes. In addition to the famous *Il libro dell'arte* of Cennino Cennini, nearly five hundred European manuscripts containing such recipes survive from before circa 1550 (roughly 17,000 manuscript pages), of which only a small fraction has been published. In collaboration with the IT department, this project has developed a database which will facilitate access to the recipes and fashion the conceptual tools to answer such questions as the following: How were recipes used in the

Hanko Pfaffen Döbringer (scribe)
Ms. 3227a, c. 1390, Germanisches
Nationalmuseum, Nuremberg

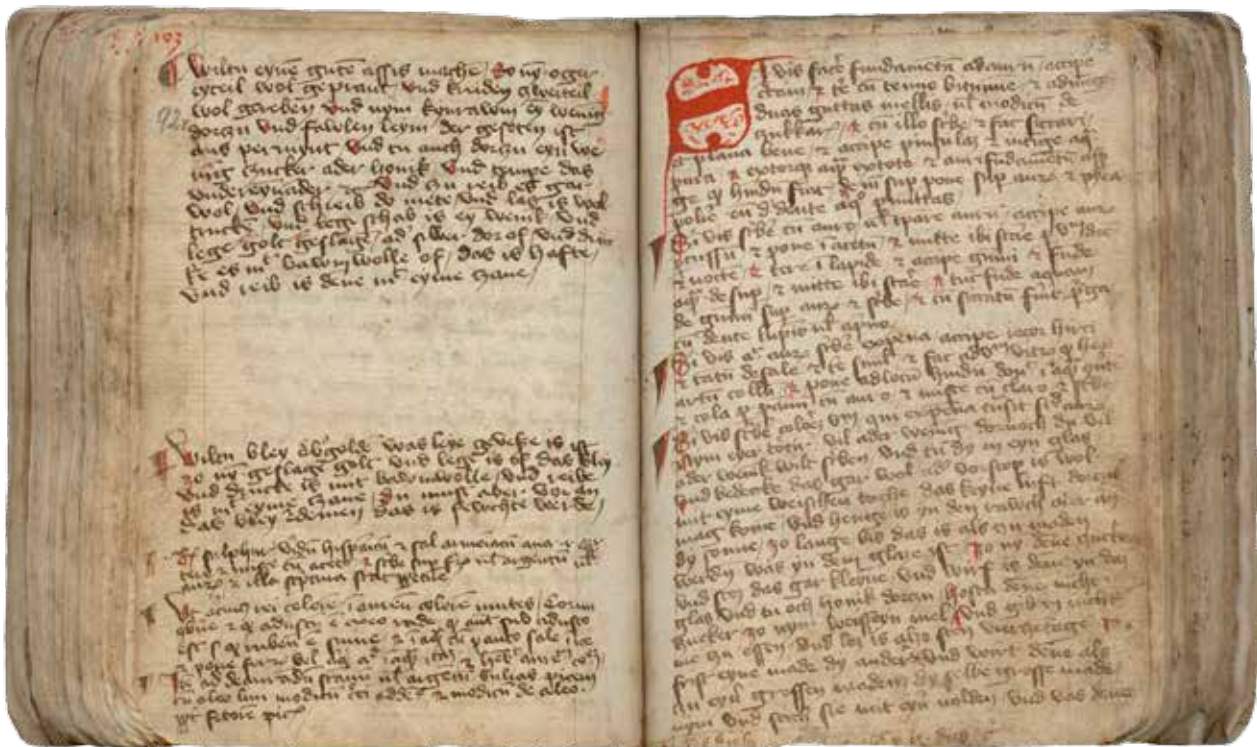

context of artists' workshops? Was new vocabulary required to translate workshop practices and practical knowledge into the format of artists' recipes? In which ways were artists' recipes related to "books of secrets"? Who collected artists' recipes? How did they read them?

The core data are medieval and premodern manuscripts and printed books from northern and southern Europe. More than four hundred source manuscripts have already been entered, with details such as title, current location, place and date of origin, scribes or authors, previous owners, and description of any content not related to color recipes. From this initial interface, the digital images of the manuscripts can be accessed. Each recipe book has been subdivided into recipes. Five thousand recipes — some a few lines, others covering several folios — have been transcribed. At the time of writing, the database is strongly geared toward artists' recipe books prior to circa 1550, but the expectation is that later materials from up to 1650 as well as other written sources related to color will be added in the course of 2013.

Ultimately, the database will be open-access and available in the Max Planck Digital Library. For now, the database is an important research tool in the following areas:

(a) A Survey of Artistic Materials and Techniques

The database allows us to study the geography, chronology, circulation, and diffusion of artists' knowledge. We can observe the global frequency and recurrence of each ingredient and technical instruction, deduce the availability of artistic material in a chronologically and geographically defined area, and trace how recipes were modified over time or by other external phenomena. It is also possible to link and correlate the development of specific artistic procedures and technical traditions with more widely diffused techniques.

(b) Color Terminology

A central aim of the project is to consider and evaluate the importance and interest accorded to knowledge of the materials and substances used by artists and shared with other professionals (such as apothecaries), focusing on pigments and coloring material. In parallel to the physical descriptions of pigments and colorants, these written sources deliver information about their optical characteristics, conservation, (in)compatibility with other sorts of materials, and aging properties. The diversity of color denominations and the complexity of the varied technical terminology are made transparent through a glossary of all substances, ingredients, and their synonyms.

Questions of terminology, the invention of vocabulary, and the translation of workshop practices are central to the book *Translating Knowledge in the Early Modern Low Countries*, edited by Harold Cook and Sven Dupré (Munster and Zürich, 2012). The conceptual frameworks in this book informed the international workshop "Colour Terminology," which was organized by research group members Karin Leonhard and Sylvie Neven in collaboration with Carole Biggam and Mark Clarke, and held at the MPIWG on January 31 and February 1, 2013. Drawing from recipes collected on the database, the workshop participants (historians of science and medicine, technical art historians, linguists, and art historians) looked into the history of technical color

terms, the use of different registers of color vocabulary, and the interaction of color language and culture, thereby addressing questions of color terminology and semantics in an interdisciplinary, historical, and systematic way.

(c) Transmission of Artists' Recipes

Recipes, and collections of recipes, are often found gathered together with other subjects, such as theology, alchemy, botany, or medicine, in one book and these other subjects are also described in the database. The database includes information concerning the provenance and circulation of these books outside the workshop. This information allows other questions to be addressed — notably, questions related to the ownership and readership of collections of recipes.

Questions on the function and transmission of artists' recipes are central to *Transmission of Artists' Knowledge* (Brussels, 2012), a volume edited by Mark Clarke, Bert De Munck, and Sven Dupré. During Mark Clarke's residency at the MPIWG in February 2012, he also worked on the following closely related individual project.

screenshot of COLOURconTEXT start page



Mark Clarke

Mark Clarke (Postdoctoral Research Fellow)

The Co-transmission of Mediaeval Paint Recipes As an Indicator of the Interpenetration of Color Theory, Artists' Practical Knowledge, and Domestic Science

While most commentators on medieval art-technological texts have taken them to be straightforward records of contemporary workshop practice, a not insignificant minority opinion is that they are para-literary compositions, divorced from workshop praxis, intended not for the craftsman but for a “literary” or “philosophical” reader. This view has largely been based on the observation that certain recipes appear unchanged for centuries. However, although certain texts do indeed seem to redact earlier material to suit a “general reader,” some redactors adjusted texts to make them more relevant to current workshop practices and requirements. One approach to

clarify the use of such texts is to consider the textual context of the transmission. This approach can provide an indicator of the intended practical or theoretical use of a given manuscript copy: in certain cases, this embedded context is encyclopedic; in others, clearly workshop-oriented. Thus, examining the co-transmission of medieval paint recipes alongside other material provides an indicator of the interpenetration of color theory, artists' practical knowledge, and domestic science.

The database *Colour conText* is also an important research tool for the “Color in Art and Color in Nature” projects (see below). Medical and art technological recipes not limited to color are approached from multiple perspectives (including the history of reading) at the monthly reading group co-organized by Sven Dupré and Elaine Leong (Minerva Research Group Leader, Department II) since October 2012. The reading group has already proved to be a crucible of ideas on the transmission and function of artists' recipes that deserve further exploration in the workshop “Reading How-To,” which Sven Dupré is organizing in September 2014 at the MPIWG, together with Doris Oltrogge and Elaine Leong.

Barbara Tramelli (Predoctoral Research Fellow)

Around Lomazzo: Artists' Education and the Appropriation of Knowledge in Sixteenth-Century Milan

This predoctoral project focuses on another type of writing (books) and approaches art theory with the methodological tools developed by historians of science and of the book. The artistic scene in sixteenth-century Milan was incredibly dynamic and active, and a key figure of the period was the Milanese painter Giovanni (Gian) Paolo Lomazzo. His writings (the famous *Trattato*, the shorter *Idea del Tempio della Pittura*, the peculiar *Libro de' Sogni*, and the collection of poems entitled *Rabisch*) are a valuable source of information to investigate the types of knowledge circulating among Milanese artists and artisans of the period. Lomazzo considered practical and theoretical knowledge both complementary and necessary for painters, and his activity as member and chief of the Accademia de la Val di Blenio testifies to his ambition to gain a reputation beyond that of a painter. Moreover, his interactions with figures belonging to the intellectual life of the city, such as Bernardino Baldini, Guido Mazzenta, and Girolamo Cardano, to name but a few, demonstrate the wide range of his interests. Starting from an analysis of Lomazzo as a writer and a reader (of recipe books, among others), and of the notions contained in Lomazzo's books, this project investigates what kind of knowledge artists from the Milanese environment acquired and shared among themselves, which books they had access to, and which notions can legitimately be said to have had an impact on their working methods.



Barbara Tramelli

Artists' Optical Knowledge

This project focuses on artists' production and appropriation of optical knowledge. Artists' appropriation of *perspectiva*, the science of optics with its roots in antiquity, was not limited to the geometry of linear perspective. Painters were equally interested in the effects of reflected and refracted light on different types of textures, surfaces, and materials. Moreover, the creation of visual depth was also made possible by means other than Albertian perspective. The different projects tackle artists' optical knowledge from different angles. Marjolijn Bol's project studies how artists and artisans, including goldsmiths and glass painters, used knowledge about light in the production of their works, whereas Sven Dupré's project looks at how artists and artisans transformed bodies of optical knowledge as well as images of optics. Practical knowledge is central to these projects on optics (as it is to projects on the impact of practitioners knowledge in other fields in Department I; see Matteo Valleriani et al.). The digitization project in collaboration with the Bibliotheca Hertziana supports the research project. The practice of perspective, opening up the plurality of means to create the illusion of depth and the polysemy of optics, is the focus of the working group in collaboration with the Centre Alexandre Koyré.



Rogier van der Weyden (attr.)
"The Annunciation," c. 1435 (detail from
the center panel of a triptych, originally
part of the altar in the church at Chieri,
near Torino. The side panels are in the
Galleria Sabauda in Torino) Paris, Louvre,
Departement des Peintures, INV 1982

Sven Dupré (Research Group Director)

The Optical Life: Transformations of Optics in the Pre-modern Period

The fourteenth century saw the establishment of a highly regarded discipline of optics, known as *perspectiva*, which was centrally located on the medieval map of knowledge and firmly embedded in the authoritative educational context of the universities. In the fifteenth and sixteenth centuries, *perspectiva* was also transmitted and appropriated outside the universities, in artisanal workshops and artists' studios. By studying the role of traveling objects and of media in this transmission, the project shows how objects and the concepts used to make sense of them acquired new meanings. Finally, the scope of the discipline of optics changed as a consequence of the appropriation of *perspectiva* in new sites, and the aims of the discipline together with the rhetoric surrounding those alleged aims became increasingly varied.

This project studies the long-term development of optics between circa 1400 and circa 1700. The central objects of study are the practices of optics and how these practices — the “optical life” — interacted with changing images of the discipline of optics, namely, the changing boundaries, scope, and aims of optics. The accepted view is that the “new optics” of the seventeenth century was the natural outcome of *perspectiva*, with which it shared not only concepts but also a vision of the scope and aims of the discipline of optics. This project paints a completely different picture of the long-term development of the history of optics in the premodern period: the “new optics” of the seventeenth century emerged from competition and conflicts between various images of optics.



Sven Dupré

Collaboration with Jeanne Peiffer (Centre Alexandre Koyré, Paris)

Working Group and Edited Book Project: Perspective As Practice

This working group is a correction to the ways in which Erwin Panofsky's *Perspective As Symbolic Form* (written more than eighty years ago) has shaped the historiography of perspective up to the present day, despite recent important interventions by James Elkins and Hans Belting. The group addresses the production and circulation of optical knowledge in workshop and design practices of the visual and decorative arts and (garden) architecture between the fourteenth and seventeenth centuries. Topics embraced include both the practical optical knowledge produced in the context of artists' workshops and artists' appropriation and use of the science of optics. The working group discusses the material practices of artists (as diverse as gardeners and goldsmiths) in imitating and representing the effects of light, creating the illusion of space and the shaping of landscape (from the use of paper and instruments, and on site, to experimentation with the optical qualities of pigments and binding media).

This group takes into account the polysemy of perspective associated with the practice of perspective. This approach elicits the variety of uses and different meanings of *perspectiva* during the period between 1400 and 1700 and across the wide range of artists' appropriations of optical knowledge. By situating artists' optical knowledge in workshop and design practices, the group is attentive to a variety of constructions that create the illusion of space, and pay as much attention to other types of optical knowledge as to the geometry of perspective. The initial conference at the MPIWG in October 2012 will be followed up with an authors' workshop at the Centre Alexandre Koyré in May 2013.



Jeanne Peiffer



Klaus E. Werner



Andreas Thielemann

Klaus E. Werner, Sven Dupré, Andreas Thielemann

Digitization Project in Collaboration with the Bibliotheca Hertziana [Perspectiva+]

In collaboration with the Bibliotheca Hertziana (Max Planck Institute for Art History) in Rome, the research group is developing the digital platform [Perspectiva+] for the history of optics and its various appropriations in the decorative and visual arts from the fifteenth to the seventeenth centuries. Taking as a starting point artists' reception and appropriation of Alhacen's *De aspectibus*, the treatise that shaped the science of optics from the eleventh century on, the digital platform integrates manuscripts, printed editions, and translations of Alhacen's treatise and other optical texts with historical and modern comments in the manner of a virtual workbench, enabling interdisciplinary research and collaboration for and between historians of science and art historians.

Optical source texts have been digitized with special attention to legibility and usability for research. From January 2013, the digital platform will be available as an open access resource on websites of the MPIWG and the Bibliotheca Hertziana. A special feature of this digitization project is that it allows scholarly users to annotate the documents; to view other users' notes and reply to them; and to put links inside an annotation, which can forward to another part of the same document, to a specific part of another document in the [Perspectiva+] platform, or even to external Web pages. The platform will be an important research tool for the working group and the research group director's project on transformations of optics in the pre-modern period.

Collaborative annotations on text and images in a digitized edition of Friedrich Risner's "Opticae Thesaurus" from 1527 <http://perspectiva.biblertz.it>



Marjolijn Bol (Postdoctoral Research Fellow)

Crafting Splendor and Examining Light: The Artisan's Contribution to the Study of Optics, 1100–1700

This project not only investigates how the characteristic Northern fascination with splendor created a fertile ground for crafts that in many ways afford luster and shine through polishing, faceting, forging, and imitating refractive and reflective materials; it also demonstrates that the love of these materials led to a better understanding of their optical properties and, by extension, stimulated optical theory. Drawing from a combination of art technological sources, technical research, medieval lore, and natural philosophical texts, Marjolijn Bol is examining how the deeply rooted exchange between natural philosophers and artisans such as goldsmiths, glassmakers, painters, and ceramicists resulted in theories about the behavior of light and ideas concerning the origin and characteristics of the material splendor made by nature itself.



Marjolijn Bol

Dalia Neis (Predoctoral Research Fellow)

Spinoza As Lensgrinder and Philosopher

Taking as a starting point René Descartes' advocacy of the hyperbolic lens system, this project explored the extent to which this legacy was practiced by Spinoza's contemporaries, including the local Dutch astronomer, lens maker, and optical theorist Christian Huygens (1629–1695) and the Dutch mayor of Amsterdam and mathematician Johannes Hudde (1628–1704). Research on their optical work and their correspondence with Spinoza enabled greater insight into the philosopher's resistance to the hyperbolic lens system in favor of the spherical lens; moreover, the question of how this resistance formed part of Spinoza's critique of Descartes' metaphysical work was addressed. This research paved the way for further study which substantiated the potential influences of Spinoza's optics on his metaphysics and, conversely, the influence of his metaphysics on his optics in mapping out the historical emergence and possible convergence between these two "fields of knowledge."



Dalia Neis

Color in Art and Color in Nature

In the seventeenth century, a huge epistemic shift led to a revised understanding of color in nature and color in art. At the same time that radical changes were taking place in theories of vision and matter, artists and scientists began to share an interest in colors as paint and as natural phenomena. At the end of the sixteenth century, natural philosophy and anatomy began to interact significantly in questions of color, vision, and the eye, while anatomists and artists worked together to produce anatomical engravings and paintings. Scientists, on the other hand, visited painters in their workshops and showed interest in their practical knowledge of color preparation and color mixture. This project centers on the varying conceptual framework of color theory, be it in natural philosophy, medicine, chymistry, or art. The title “Color in Art and Color in Nature” refers both to distinct groups of historical actors engaged in color theory — natural scientists and artists, among others — and to the distinction between art and nature made within these groups. Not only was there a disciplinary interpenetration of theories about natural and artificial color and color mixing along with an exchange of practical techniques and experiences, but a significant reconceptualization of the boundary between artificial and natural color itself. The database “Colour conText” (see above), mining the group’s primary source materials on color, is an important research tool for this project.

The project consists of three subprojects, each firmly grounded in, respectively, art history, art technology, and history of science, with important crossovers.

Examples of color mixing and color combinations for illuminations from the so-called “Cologne Patternbook,” 15-16 C., Cologne historical archives, Ms. W 8° 293.

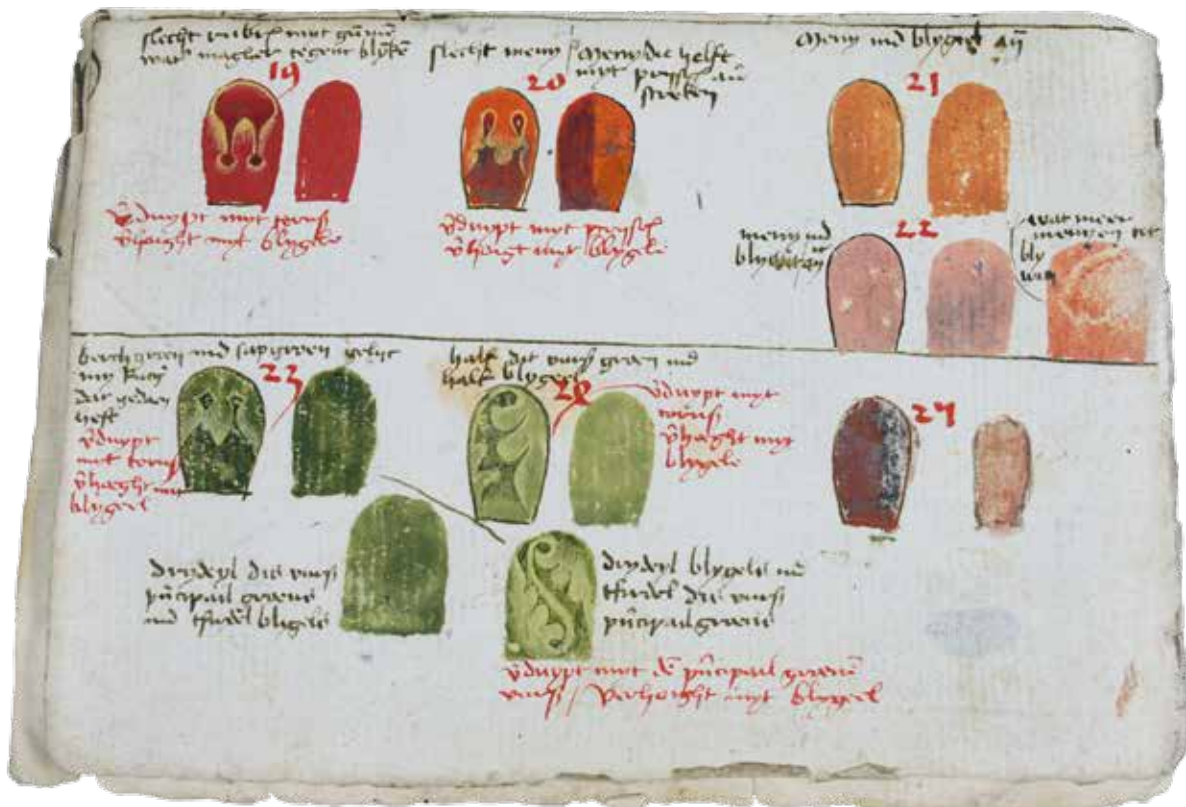

Karin Leonhard (Research Scholar)

Color Does Matter

This project concentrates on baroque color theory and practice in the histories of art and science. It is based on cooperation between the disciplines of art history, the histories of science and philosophy, and museum restoration work. This interdisciplinary approach is particularly appropriate because the creation of a systematic color order came about through the exchange of art, natural philosophy, and science. Hence, this project investigates seventeenth-century artists' recipes and technical treatises as well as art theoretical, philosophical, and scientific writings on color.

A review of recipes, artists' treatises, and baroque writings on color practice and theory is followed by an outline of the extent of the surviving material, the contexts in which it has survived, and the difficulties of technical terminology. A chronological review of the nature of technical texts from the beginning to the end of the seventeenth century is being constructed, covering their origins, transmission, type of content, and relevance to actual contemporary workshop practice.

The corpus of available writings on color rapidly expands when we consider not only art theoretical treatises but also practical manuals for the art of limning, dyeing, or cosmetics. In addition, early lapidaries, books on glassmaking and botanical treatises, and the whole range of baroque literature on color symbolism should be considered. The project will center on the epistemic simultaneities in the varying conceptual frameworks of color theory, be they in natural philosophy, physics, or art.



Karin Leonhard

Sylvie Neven (Postdoctoral Research Fellow)

Illuminating the Elusive: Organic Colorants in Northern European Illuminations

Due to their trade value, a wide range of artistic materials were documented and recorded in historical written sources. However, other substances had no market value and thus cannot be found in these archives. In particular, vegetal species commonly found in nature and favored by artists for their coloring properties (flavonoid and anthocyanin) are not included in these archives. Because they are highly unstable in ordinary daylight, it has always been assumed that these colorants were not used in painting or to dye quality materials. To complicate the issue, these colorants are difficult to identify through archaeometric analysis. For all of these reasons, these materials have remained “elusive” and have not yet been the subject of academic investigation.

This project, funded by the Fonds de la Recherche Scientifique, Fonds national de la recherche scientifique (F.R.S.-FNRS), sheds light on these “elusive” substances by closely examining an original and primary source: artists' recipe books. Until now, it was thought that these organic colorants were used only in domestic contexts, for the dyeing of everyday clothes. Yet these books both describe these substances and indicate their use in illumination. This research will significantly increase our knowledge of historical artistic practices and materials and will also help to identify specific artistic productions and workshops.



Sylvie Neven



Tawrin Baker

Tawrin Baker (Predoctoral Research Fellow)

Color, Vision, and the Eye in Late Sixteenth-Century Padua

Questions surrounding the origin of color, its relationship to light and illumination, and how color affected the eye were vigorously debated within the many forms of Aristotelianism at the end of the Renaissance. Color theory provides a crucial link between matter and vision, between theories of vision and anatomical investigation of the eye, and between craftsmen, artists, physicians, and schoolmen. However, these accounts of color and perception have not been well studied, and thus the question of how scholastic accounts engaged with, influenced, and were modified by ideas and practices outside universities is also rather obscure. Additionally, although much has been written about Kepler, Galileo, Descartes, and Newton, unless a detailed analysis of theories of vision and of the sensible qualities held by earlier figures is carried out, the monumental changes that took place in the seventeenth century will be imperfectly understood.

This project investigates theories of color and vision held by three influential figures at the University of Padua: Jacopo Zabarella, professor of logic and natural philosophy; Hieronymus Fabricius ab Aquapendente, professor of surgery and anatomy; and Julius Casserius, Fabricius's servant, student, and eventual colleague and rival in surgery and anatomy at Padua. All three are noteworthy for the interdisciplinary nature of their investigations — they all provided detailed philosophical accounts of the generation of color, its nature, and the nature of vision, as well as anatomical accounts of the structure, action, and utility of the eye. All three were also active in broader intellectual circles in Padua and Venice which included artists, literati, and virtuosi. Additionally, the two anatomists worked closely with artists to produce celebrated anatomical engravings and, in the case of Fabricius, colored tables. These figures thus give us an important window onto the dynamic relationships between color, philosophy, anatomy, and art on the edge of the scientific revolution.

Karin Leonhard and Sven Dupré are organizing two working group conferences on “Early Modern Color Practices” at the MPIWG in September 2013 and March 2014.

Art and Alchemy

Working Group and Edited Book Project: Laboratories of Art

In the fifteenth and sixteenth centuries, the term *laboratorium* was used to designate a specific place of work for the alchemist. But long before this term came into use there was already considerable overlap between artists' workshops and the work spaces of the alchemist. An important component of alchemy was chemical technology, which was used in fields of art and craft to make pigments and artificial gemstones (among other products). The overlap between art and alchemy is one of materials, instruments, and apparatuses as well as of processes and experiments. This shared experience of tools and procedures did not exclude difference and contention. The working group is no less interested in the processes of differentiation between art and alchemy than it is in their shared knowledge. Among the topics that the working group addresses are the organization and material culture of artists' workshops and alchemical laboratories, the shared knowledge of materials and processes of attribu-

Adriaen van Utrecht "Allegory of Fire," detail, 1636, Brussels, Royal Museums of Fine Arts of Belgium, photo J. Geleyns



tion of meaning to materials in art and alchemy, and notions of imitation and transmutation in art and alchemy.

The working group contributes to an epistemology of materials against a background of changing notions of “art” and “alchemy.” In exploring the relationships between knowledge, technology, and the arts, the group deals with all visual and decorative arts: painting and sculpture as well as the so-called arts of fire. Among the arts and technologies discussed are glassmaking, metallurgy, mining, sculpture, goldsmithing, the production of jewelry, majolica and porcelain, and painting technology.

Exhibition in collaboration with Museum Kunstpalast, Düsseldorf



Dedo von Kerssenbrock-Krosigk



Lawrence Principe

Sven Dupré in collaboration with *Dedo von Kerssenbrock-Krosigk* (Museum Kunstpalast) and *Lawrence Principe* (Johns Hopkins University)

The Museum Kunstpalast in Düsseldorf is planning a special exhibition on art and alchemy, which will be on view from April 4 to August 10, 2014. The exhibition, part of the “Quadriennale” of the city of Düsseldorf, is a joint venture with the Museum Kunstpalast Foundation, and a group of experts linked with the Chemical Heritage Foundation, Philadelphia, in particular Lawrence Principe. Together with Dedo von Kerssenbrock-Krosigk, Sven Dupré organized an international workshop on art and alchemy at the MPIWG in February 2012. This workshop sowed the seed of the concept of the exhibition, offering insights into the different and changing identities of alchemy and the multiple connections of alchemy to the visual and decorative arts.

An important section of the exhibition addresses chemistry and the arts. The knowledge and the experience derived from alchemical experiments were omnipresent in many areas of pre-modern life. A number of decorative arts are grounded in alchemy (understood as chemical manufacture), such as the production of glass and porcelain. But also work with iron, silver, gold, and bronze, the manufacture of a number of pigments, and the production of medicines and perfumes are all partly based on alchemical research. The working group conference “Laboratories of Art,” which took place at the MPIWG in March 2013, aimed at conceptually developing this section.

Artists Inside Collections

Apart from oral communication between master and apprentice and written transmission, several types of material objects mediated the exchange of knowledge in the artist's workshop. This project investigates the ways in which early modern artists collected antiquities, instruments, and *naturalia*, and traces how artists' collections shaped concepts of art theory and art itself. The three subprojects look at this issue from different angles. The first project is particularly concerned with the blurred line between artists' workshops and collections, using artists' collections in the Netherlands as its source materials. The second project focuses on the role of artists in Venetian natural history collections. It examines artists' involvement in collections through the preparation of specimens, and the production of replicas and fakes. This project also opens a window onto processes of sharing knowledge about materials between artists and naturalists and apothecaries. The third project takes up the case of the collection of the merchant-banker Emmanuel Ximenes in early seventeenth-century Antwerp, in order to investigate how early modern collections functioned as sites for the production of art and knowledge.

Willem II van Haecht, "The Cabinet of Cornelis van der Geest," 1628, Rubenshuis, Antwerp





Marlise Rijks

Marlise Rijks (Predoctoral Research Fellow)

Artists' Collections in the Early Modern Netherlands

This project shows how the collections of artists and artisans in the early modern Netherlands became sources of artisanal and scientific knowledge as well as artistic innovation. In recent years, a great deal of literature has been published on the culture of collecting in relation to artistic and scientific developments in early modern Europe. Most existing research focuses either on art collections in relation to the art market and connoisseurship or on the role of scholarly collections in relation to global trade networks and new scientific knowledge. Specific research on the collections of artists (e.g., painters, goldsmiths, mirror makers) is strikingly absent (with the exception of some research on the collections of Rubens and Rembrandt). Investigating objects collected by artists and artisans reveals the intersections of art, knowledge, and commerce. We know that artists collected objects ranging from antiquities and books to *naturalia* and instruments. The Antwerp painter Frans I Francken (1542–1616), for example, collected artifacts, books, drawings, jewelry, “Indian feathers,” shells, and fossils.

This doctoral research project, funded by the Research Foundation Flanders (FWO), is being carried out in cooperation with the University of Ghent (Koenraad Jonckheere). The first phase of the project focuses on the collections of artists in Antwerp in the early seventeenth century. During her time at the MPIWG, Marlise Rijks composed a database of written sources on artists' collections in Antwerp. In a later phase, the project will extend to include the collections of artists in a city like Delft or Haarlem. A comparison between the culture of collecting in the Southern and Northern Netherlands after their separation will yield new insights into the supposedly diverging paths of collecting and the development of science in the Spanish Netherlands and the Dutch Republic.



Valentina Pugliano

Valentina Pugliano (Postdoctoral Research Fellow)

Role of Craftsmen and Artisans in the Natural Historical Collections of Sixteenth-Century Venice

From the fifteenth century, ancient botanical texts and new lands conspired to stir the curiosity of many, prompting the hoarding of both natural and man-made *notabilia*. Scribes with a talent for sketching became sought-after during herborizations. Miniaturists and engravers were regularly commissioned by connoisseurs to reproduce the *naturalia* displayed in their cabinets. Artists themselves addressed themselves to these smaller subjects to hone their hand and eye, and began to see the skillful depiction of flora and fauna as a stepping stone towards making a name for themselves at European courts.

This project examines cases at the cusp of science and art that showcase different contexts of interaction between scholarly and artisanal knowledge and practice. The analysis focuses first on the channels through which the (usually male) artisan/artist arrived at these cabinets, and on his daily interactions with specimen suppliers (such as apothecaries, hunters, and fishermen). The project then turns to his manipulation of the specimens themselves, in light of the experiences that naturalists had in their museums in the same period. Both categories were involved in the study of materials

and their properties, albeit for different purposes, with a significant overlap between the resins, minerals, vegetable dyes, and metallic pigments employed by the craftsman and the valued *naturalia* stored by the naturalist.

Special attention is paid to the role of medical artisans in the natural historical collections of sixteenth-century Veneto and Emilia Romagna. Focusing on the Venice-based charlatan Leone Tartaglini (fl. 1560–1576) and his preparation of three-dimensional specimens and sought-after fakes, the project explores the importance of craftsmen in the creation of museum specimens, especially in relation to the development of techniques for the preservation of organic material. Through these creations, the project traces the artisan's role in the study of the properties of materials and in fostering a debate on the nature of scientific connoisseurship.

Sven Dupré in collaboration with Christine Göttler (University of Bern)

**Art, Science, Local History, and the New World in Counter-Reformation
Antwerp: The Collection of the Portuguese Merchant-Banker Emmanuel
Ximenes**

This project investigates one of the most splendid collections in early seventeenth-century Antwerp, that of the Portuguese merchant-banker Emmanuel Ximenes (1564–1632), a neighbor and contemporary of Peter Paul Rubens (1577–1640). In this period, thanks to the Portuguese, Antwerp was the most important trading center north of the Alps and was renowned as a center for the manufacture of and trade with luxury goods. Ximenes was praised by his contemporaries for his “universal knowledge of the sciences,” and his collection linked the spheres of art, alchemy, medicine, commerce, and religion. Ximenes' collection included a remarkable number of the newest mathematical and optical instruments, many of them produced by the Antwerp mathematician Michiel Coignet; a *Distilleer- en Alchimiecamer*; and a library holding over one thousand volumes.

Christine Göttler and Sven Dupré are currently working on two publications related to this project. The first is an edited book, *Artificii Occulti* (Hidden Artifices), which explores the notion of artistic and artisanal knowledge in the city of Antwerp and the Spanish Habsburg world to which Ximenes belonged. A second book-length study will focus specifically on the inventory of Emmanuel Ximenes' possessions brought together in his palace on the Meir, one of Antwerp's most luxurious streets. To this end, in November 2012, Sven Dupré and Christine Göttler, in collaboration with the Rubenianum (the world's premier research center and library on Rubens), organized a workshop in Antwerp, “Reading the Inventory,” bringing together experts on material culture.

A special point of interest is the alchemy and distillation chamber in Ximenes' house. Sven Dupré has investigated how Ximenes' alchemical interests relate to the manufacture of and trade with one specific decorative art object (glass) and to the Florentine court culture of art and science centered on the Casino di San Marco of Antonio de' Medici. Close study of the letters sent between Ximenes and the Florentine alchemist Antonio Neri helped illuminate glass production at the Medici court in Florence. Neri's interest in colored glass, seen in his *L'Arte Vetraria*, was put into relation with Don Antonio's own recipes for faking gemstones using similar methods.



Christine Göttler



Sean Nelson

Sean Nelson (Predoctoral Research Fellow)

Antonio de' Medici and the Art of Alchemy

This project addresses the intersections between artistic production and alchemical experimentation within the writings of Don Antonio de' Medici. Focusing on the *Apparato*, this study observes the shared alchemical contours of processes such as glassmaking and pigment production. In his manuscript, Antonio noted recipes for tempering ultramarine and coloring glass among entries on medicinal purges and the philosopher's stone. Following the model of a book of secrets, the text introduced an uninitiated reader to the expansive arts of alchemy.

The Medici prince's concomitant collecting of glassware, painting, and sculpture at his home, the Casino di San Marco, further reflects the intersections of such interests. Along with paintings such as Leonardo's *Adoration of the Magi*, Don Antonio displayed the creations of his own foundries in his gallery. For Don Antonio de' Medici, the gallery was an important venue for displaying the potential of the arts of alchemy.

Visiting Scholars



Nadja Baadj

Nadja Baadj (Visiting Scholar)

Crafting a Natural History of Art in Early Modern Antwerp

This project examines the relationship between craft, curiosity, and the pursuit of natural knowledge in Antwerp during the second half of the seventeenth century. In contrast to the intellectual and scientific milieu fostered by competing academic centers in the Northern Netherlands, the production and dissemination of natural knowledge in Antwerp was aimed at a broader population that included merchants, craftsmen, and entrepreneurs, as well as collectors and connoisseurs of art. Antwerp artists and artisans played an instrumental role in mediating the transmission of natural knowledge to this diverse audience, producing works that encouraged viewers to simultaneously think about art in terms of collecting, connoisseurship, citation, media, and materials, and think anew about nature. Artists' workshops and collections served as important sites of knowledge production and exchange. This project explores the objects and networks created by these arbiters of natural knowledge, and considers how they contributed to the representation and marketing of a distinctly Antwerpian vision of the natural world.



Paola Bertucci

Paola Bertucci (Visiting Scholar)

Perfecting the Arts in Eighteenth-Century Paris: Craft Knowledge and the Sciences at the Société des Arts

Previous analysis of the short-lived Société was at least in part determined by the availability of very few sources documenting its composition and range of activities. Recently, however, a private archive containing the minutes of the Société's meetings and some correspondence between members has been made available, and a new

interpretation of the Societ s fortunes and misfortunes is now possible. This project focuses on these new sources, which tell a story of practical and intellectual exchanges, rather than rivalry, with the Acad mie des Sciences. They also help answer several new questions about the Societ s program — the perfecting of the arts — and its significance in the context of Paris academic culture and the French mercantilist economy. The Societ  des Arts represented a key moment in which highly skilled artisans attempted to formulate a normative program for technical innovation aimed at exerting influence on the political economy of the Bureau of Commerce, as well as on a number of cultural activities promoted by members of the Acad mie des Sciences.

Thijs Weststeijn (Postdoctoral Research Fellow)

China in the Studio: Painting Porcelain in the Seventeenth-Century Netherlands

European fascination with Chinese porcelain began when the first cargo reached Middelburg in 1602. Within four decades, the Dutch had imported over three million pieces. Artisans and artists were the first to explore the epistemological dimension of this exchange. Potters tried to recreate the new material. Painters confronted a challenge of material, stylistic, and thematic dimensions. Painted porcelain references the association between the much-discussed ‘secret’ of making porcelain and the alleged ‘secrets’ of the artist’s workshop. For instance, chemists tried to grind the Chinese objects and used this powder as a basic material. This project explores whether, on the micro level of technical preparation, painters envisioned structural similarities between their work and chemistry. In addition, still-life paintings featuring china expressed the artists’ interest in exoticism as well as in surface textures and optical qualities. Rembrandt displayed authentic chinaware in his own house, and Dutch porcelain imitations became a feature of interiors painted by Vermeer and Van Hoogstraten. It was partly due to such depictions that china became associated with the “Dutch” domestic and commercial virtues. More essentially, painted porcelain was a visual reflection of the Netherlands’ opening up to the scientific revolution and to trade in an increasingly globalized world.



Thijs Weststeijn

Steve Wharton (Visiting Scholar)

Cipriano Piccolpasso and the Transmission of Knowledge

The Three Books of the Art of the Potter... (1556–1579), the mid-sixteenth-century treatise written and illustrated by Cipriano Piccolpasso (1523–1579), has been described as a textual and visual celebration of the decorated tin-glazed earthenware pottery produced in Castel Durante and Urbino, two of the most prestigious manufacturing centers at that time. This project focuses on wider cultural concerns incorporating both the visual culture of the period and the dissemination of certain kinds of knowledge. Specifically, it focuses on how potters formulated and adjusted their recipes so that their colors conformed to the palette employed by other painters; and to what extent the use of gold luster, particularly on that work produced in Urbino, was understood in terms of technological practices derived from alchemy. While at the MPIWG, Steve Wharton examined evidence of the technological development and subsequent consistency through which the demand for *istoriata* ware was



Steve Wharton

achieved and secured. What things looked like was clearly important; and while it was the narratives depicted and the use of a culturally specific palette that were crucial to the success and status of pottery as a consumer good, it was the dissemination and the ubiquity of the relevant technology that enabled the makers of pottery to respond to the demands of society and fashion.

Collaboration with the Freie Universität Berlin



Celine Camps

As part of the cooperation in the history of knowledge between the MPIWG and the three main universities in the German capital, Sven Dupré has been appointed Professor of History of Knowledge at the Department for Art History at the Freie Universität Berlin. In this capacity, he supervises or co-supervises six dissertations (including those of Marlise Rijks and Barbara Tramelli; see above) and organizes a predoctoral seminar in collaboration with Barbara Tramelli; he also (together with Veronika Lipphardt) chaired the Berlin Doctoral Forum of the History of Science in December 2012. The research group also hosted Celine Camps, an exchange student in the master's program of history and philosophy of science and the humanities at the University of Utrecht and the Freie Universität Berlin.

Colloquia, Conferences, and Workshops

Colloquium Series

Art and Knowledge in Pre-modern Europe

External Guest Speakers:

- November 24, 2011: *Jeanne Peiffer* (CNRS), Centre Alexandre Koyré
- December 12, 2011: *Pietro Roccasacca*, Accademia di Belle Arti di Roma
- January 26, 2011: *Michael Thimann*, Universität Passau & *Claus Zittel*, Freie Universität Berlin; Max Planck Research Group “Das wissende Bild” at the Kunsthistorisches Institut in Florenz– Max-Planck-Institut
- April 23, 2012: *Anke te Heesen*, Humboldt-Universität zu Berlin
- June 11, 2012: *Lawrence Principe*, Johns Hopkins University
- July 2, 2012: *Marco Beretta*, University of Bologna/Museo Galileo, Florence
- September 17, 2012: *William Newman*, Indiana University Bloomington

Upcoming guest speakers include: *Doris Oltrogge*, Cologne Institute for Conservation Sciences; *Pascal Dubourg Glatigny*, CNRS Paris; *Susan Maxwell*, University of

Wisconsin, Oshkosh; *Anna Schoenemann*, Staatliche Akademie der Bildenden Künste, Stuttgart; *Amy Buono*, Southern Methodist University, Dallas; *Valentina Sebastiani*, Fondazione Bruno Kessler, Trento; *Anke Timmermann*, Medizinische Universität Wien; *Lucia Dacome*, University of Toronto; *Claudia Swan*, Northwestern University; *Frank Fehrenbach*, Harvard University



Art and Knowledge in Pre-Modern Europe

**Max Planck Research Group
Colloquium Series 2011-2012**

4-6 pm
in the seminar room of the Villa,
Harnackstraße 5, 14195 Berlin

**Monday 31 October 2011, Karin Leonhard
MPIWG**
Baroque Colour Theory and Still Life Painting

**Thursday 24 November 2011, Jeanne Peiffer
(CNRS) Centre Alexandre Koyré**
Perspective Appropriated in 16th c. Southern German Artists' Booklets

**Monday 12 December 2011, Pietro Rocca
Accademia Belle Arti Roma**
Representing "Remotio": "Prospettiva" between Optics and Mathematics from Masolino to Alberti

**Thursday 26 January 2011, Michael Thimann Universität
Passau & Claus Zittel Freie Universität Berlin, Max Planck
Research Group "Das wissende Bild" at the Kunsthistorisches
Institut, Florence**
The Artist as Reader

**Monday 20 February 2012, Mark Clarke
Universidade Nova de Lisboa**
Medieval Artists' Technical Recipes: Use, Re-use, Abuse

**Monday 19 March 2012, Valentina Pugliano
MPIWG, University of Oxford**
Nature Manufactured: The Artisans' Touch in Renaissance Cabinets of Naturalia

**Monday 23 April 2012, Anke te Heesen
Humboldt Universität, Berlin**
Historiography and the Display of the Infinite Amount, About Recent Exhibitions

**Monday 21 May 2012, Sylvie Neven
University of Liège, Belgium,
Commentator: Doris Oltrogge
Cologne Institute of Conservation Sciences**
The Strasbourg Tradition: Genesis and Peregrination of Artists' Recipe Books in Pre-Modern Europe

**Monday 11 June 2012, Lawrence Principe
Johns Hopkins University**
Recipes and Ideas: Another Look at the Chymical Diptych of Theory and Practice

**Monday 2 July 2012, Marco Beretta
University of Bologna / Museo Galileo, Florence**
The Glass Puzzle. (Alchemical Theories on Vitrification)

Organised by **Sven Dupré**
for further information contact:
sfd@dupre@mpiwg-berlin.mpg.de

**Max Planck Institute for the History of Science
Boltzmannstraße 22, 14195 Berlin, Germany**



MAX-PLANCK-GESellschaft

Workshop

Art and Alchemy

February 9–10, 2012

Participants

Spike Bucklow, Hamilton Kerr Institute, Fitzwilliam Museum, University of Cambridge; *Mark Clarke*, Universidade Nova de Lisboa/MPIWG; *Teresa Esposito*, University of Ghent; *Christine Göttler*, Kunstgeschichte der Neuzeit, University of Bern; *Didier Kahn*, CNRS, Paris; *Ursula Klein*, MPIWG; *Karin Leonhard*, MPIWG; *Matteo Martelli*, Humboldt-Universität zu Berlin; *Tine Meganck*, Royal Museums of Fine Arts, Brussels; *Tara Nummedal*, Brown University; *Valentina Pugliano*, MPIWG; *Jennifer Rampling*, University of Cambridge; *Maurice Yves-Christian Saß*, Ludwig-Maximilians-Universität, Munich; *Barbara Tramelli*, MPIWG; *Berit Wagner*, Kunstgeschichtliches Institut der Goethe Universität, Frankfurt

Conference

Perspective As Practice: An International Conference on the Circulation of Optical Knowledge In and Outside the Workshop

October 12–13, 2012

Participants

Hans Belting, HfG Karlsruhe; *Marjolijn Bol*, MPIWG; *José Calvo-Lopez*, Universidad Politécnica de Cartena; *Ruth Ezra*, University of Cambridge; *Georges Farhat*, University of Toronto; *J. V. Field*, Birkbeck, University of London; *Francesca Fiorani*, University of Virginia; *Alexa Greist*, Yale University Art Gallery; *Paul Hills*, Courtauld Institute, London; *Elaheh Kheirandish*, Harvard University; *Dominique Raynaud*, Pierre Mendès-France University, Grenoble; *Pietro Roccasacca*, Centre des Études Supérieures de la Renaissance, Université François Rabelais, Tours; *Peter Scholz*, Universität Zürich; *J. B. Shank*, University of Minnesota; *Mark Smith*, University of Missouri; *David Summers*, University of Virginia; *Marvin Trachtenberg*, New York University; *Klaus E. Werner*, MPIWG; Bibliotheca Hertziana, MPG, Rome

Workshop

Reading the Inventory: The Collection of the Portuguese Merchant-Banker Emmanuel Ximenes in Early Seventeenth-Century Antwerp

November 29–30, 2012

Participants

Christine Göttler, University of Bern; *Sarah Joan Moran*, University of Bern; *Krista De Jonge*, Catholic University of Leuven; *Petra Maclot*, Catholic University of

Leuven; *Jeroen Van Vaerenbergh*, Archeologische Dienst Waasland; *Bruno Blondé*, University of Antwerp; *Dirk Imhof*, Museum Plantin-Moretus; *Koenraad van Cleempoel*, University of Hasselt; *Angelo Cattaneo*, New University of Lisbon; *Pascale Vandervellen*, Musical Instrument Museum, Brussels; *Anne-Emmanuelle Ceulemans*, Musical Instrument Museum, Brussels; *Florike Egmond*, University of Leiden; *Peter N. Miller*, Bard Graduate Center, New York; *Katja Schmitz-von Ledebur*, Kunsthistorisches Museum, Vienna; *Birgitt Borkopp-Restle*, MAK, Austrian Museum of Applied Arts, Vienna; *Barbara Karl*, MAK, Austrian Museum of Applied Arts, Vienna; *Dedo von Kerssenbrock-Krosigk*, Glasmuseum Hentrich, Düsseldorf; *Anne Gerritsen*, University of Warwick; *Lawrence Principe*, Johns Hopkins University, Baltimore; *Sean Nelson*, Kunsthistorisches Institut – Max Planck Institute, Florence

Workshop

Colour Terminology

January 31–February 1, 2013

Participants

Carole Biggam, University of Glasgow; *Alexander Borg*, Ben-Gurion University of the Negev; *Galina Paramei*, Liverpool Hope University; *Jo Kirby*, National Gallery, London; *Nicholas Eastaugh*, Art Access and Research (AA&R), London; *Doris Oltrogge*, Cologne Institute for Conservation Sciences; *Sylvie Neven*, Fonds National de la Recherche Scientifique, Brussels; *Christoph Krekel*, Akademie der Bildenden Künste Stuttgart; *Sven Dupré*, MPIWG; *Sachiko Kusukawa*, Trinity College, University of Cambridge; *Karin Leonhard*, MPIWG

Conference

Laboratories of Art

March 7–8, 2013

Participants

Marco Beretta, Università di Bologna; *Andrea Bernardoni*, Institute and Museum of the History of Science, Museo Galileo; *Marjolijn Bol*, University of Amsterdam; *David Brafman*, Getty Institute; *Spike Bucklow*, Hamilton Kerr Institute, Cambridge; *Dedo von Kerssenbrock-Krosigk*, Kunspalast Museum Düsseldorf; *Henrike Haug*, Technische Universität Berlin; *Matthew C. Hunter*, McGill University; *Stephen Johnston*, Museum of the History of Science, University of Oxford; *Didier Kahn*, CNRS, Paris; *Fanny Kieffer*, Centre d'Études Supérieures de la Renaissance, Tours; *Ursula Klein*, MPIWG; *Matteo Martelli*, Humboldt-Universität zu Berlin; *Sylvie Neven*, University of Liege; *William Newman*, Indiana University Bloomington; *Lawrence Principe*, Johns Hopkins University; *Jennifer Rampling*, University of Cambridge; *Anke Timmermann*, Medizinische Universität Wien; *Morgan Wesley*, Sotheby's Institute of Art/University of Oxford; *Steve Wharton*, University of Sussex; *Alan Williams*, Conservation Department, The Wallace Collection, London

Christina Brandt presenting the book
Eine Naturgeschichte für das 21. Jahrhundert.



Joint Activities

Several events were held to honor Hans-Jörg Rheinberger on the occasion of his 65th birthday; they were organized by colleagues inside and outside the MPIWG.

Festkolloquium für Hans-Jörg Rheinberger

January 24, 2011, organized by the MPIWG

Program

BEGRÜSSUNG Jürgen Renn *Wissenschaftsgeschichte und Naturwissenschaft*

Soraya de Chadarevian, Jean-Paul Gaudillière *Experimente mit Ribosomen*

Knud Nierhaus *Wer A sagt, muß auch E sagen*

Staffan Müller-Wille *Zellen*

1. BOUQUET Peter McLaughlin, Urs Schoepflin, Martin Vingron

Bettina Wähg *Die Wahrheit über die Geschichte*

Manfred Laubichler *Biologie als Geschichte, Geschichte als Biologie*

Laura Otis *Wissenschaftsgedichte*

2. BOUQUET Anke te Heesen, Friedrich Steinle, Peter Hammerstein

Lorraine Daston *Wissenschaftsgeschichte und Philosophie*

Marcel Beyer, Michael Hagner *Variationen über Aberglauben und Epistemologie*

Katrin Solhdju *“... dann muss der Stein empfinden”*

3. BOUQUET Jutta Schickore, Peter Geimer, Uljana Feest

Die Quart-Matrix: Marija Moßburger und Gerhard Herrgott kommentieren und spielen die f-moll-Fantasie für Klavier zu vier Händen von Franz Schubert

4. BOUQUET Julia Voss, Christoph Hoffmann, Antje Radeck, Christina Brandt

The contributions are available
as MPIWG Preprint 433.

Hommage

Eine Naturgeschichte für das 21. Jahrhundert

Around seventy scholars who have worked with Hans-Jörg Rheinberger at the MPIWG between 1994 and 2010 contributed to this trilingual volume.
 Editors: Safia Azzouni, Christina Brandt, Bernd Gausemeier, Julia Kursell, Henning Schmidgen, Barbara Wittmann. Editorial Coordinator: Tomoko Mamine



New edition by Alphaeus Verlag scheduled for Autumn 2013

From the preface:

With this variety, the present volume seeks to gesture into the future, toward the natural history of the 21st century. Yet it also returns to Buffon's dictum that style is the man himself. Despite the proclaimed end of humanism, this dictum has retained its interest. It merely needs an amendment that can be found in another preface: "Le style est l'homme à qui l'on s'adresse." Style, then, is tied to exchange, to dialogue, to recognition. It rests on an open culture of give and take. And it is in this sense that the present book, with profound gratitude, addresses itself to Hans-Jörg Rheinberger.

VORWORT	6	— PFLANZEN —		— TIERE —	
PREFACE	11	Broadway Perpetual	50	<i>Ipseus</i>	300
		<i>Lilium</i>	51	<i>Nymphalax</i>	301
		Yucca	51	Sloth	304
— BEWEGEN —		Ouchidom	54	Pilori	305
Stochiom	55	Stochiom	55	Whale	307
Edele	58	<i>Phaon satirus</i>	58	Elefant	309
Coral Reef	60	Fig of Hell	60	Seal	311
Cerevas	62	Kwei	61	Aurite	313
Barcola	63	Franz and Gwendolm	61	Pachtelenschwanz	313
Collections	65	Praxis	64	Paradiesvogel	316
Francerville	67	Erbsen	66	Flughörnchen	317
Network	69	Timothe	68	Paul	319
Beige	71	Universalsorten	70	Kartuschen (gebrannt)	321
Garten	73			Wulfr	323
Maute Verita	75	— VORGÄNGE —		Schwein	324
Box	76	Kraftlinien	74	<i>Mus musculus flavescens</i>	327
Clasificaciones químicas	78	Bereitschaftspotential	76	Flies	328
Interactone	80	Nebel	82	<i>Proplaneta americana</i> (L.)	330
Sediment	84	Auro-formation embryonale	78	Ausfall	332
Rivers	86	Embryonalentwicklung	80	Turles	334
		Evolution	82	Tiergestalt	335
		Race	84	<i>Bardolphus inermis affinis</i>	338
		Blutdruck	86	<i>Arthropus homuli</i>	340
		Hypertension	88	<i>Leptone</i>	342
		Walking	90	<i>Paracetamol</i>	343
		Biological computing	91	Spermatozoon	345
		Random Walk	93	<i>Hydra viridis</i>	347
		Plague	95	Süßwasserrochen	349
				Spinne	350

— FLÜCHTIGES —		— ELEMENTARES —		TAFELN	357
Stausgut	74	Artemisinin	216	INDEX	359
Fluid	76	Zelle	218		
Gedächtnis	78	Faser	221	BÜCHERWEIS	390
Subwind	80	Jewans	222	IMPRESSUM	393
Kerzenflamme	82	Cell	224		
Schatten	84	<i>M. 199/JCF-199.0</i>	226		
Nebula	86	Biological modules	227		
Flame	88	Diamant	229		
Hunger	90	Electron	231		
Wine	92	Pappergötze	233		
Ether	94	Wasser	234		
Gnitte	96	Molecules	237		
Prom	98	Vitamin	238		
Smell	100	Invasive microbes	239		
Sound	102	<i>Helicobacter pylori</i>	241		
		Prom	243		
		Natural neuron	244		
		Brain	246		
		Herr	247		
		Ornament	250		
		Kugel	251		
— MENSCHEN —					
Batschi	183				
Kind 1	184				
Jockel und Ham	186				
Cyborg	189				
Hermaphrodite	191				
Human embryo	193				
Kind 2	195				
Mondmenschen	198				
<i>Homo neanderthalensis</i>	200				
<i>Homo pastus</i>	202				
<i>Homo theophrasti</i>	204				
<i>Macaca mulatta</i>	206				
<i>Homo transgressus</i>	208				
Alphatier	210				
Zombie	212				

MPIWG Preprint 411

Hans-Jörg Rheinberger: A Bibliography

Compiled by Anke Pietzke and Matthias Schwerdt
EDITORS Henning Schmidgen and Urs Schoepflin



Conference

Epistemology and History

From Bachelard and Canguilhem to Today's History of Science

Conference of the Institut d'Histoire et de Philosophie des Sciences et des Techniques, Sorbonne, and the MPIWG with support of the Centre Marc Bloch.
ORGANIZERS Henning Schmidgen, Peter Schöttler, and Jean-François Braunstein
Berlin, December 9–11, 2010

Program

PROSPECTUSES

Epistemology and History
Épistémologie et histoire
Epistemologie und Geschichte

INTRODUCTIONS

Henning Schmidgen *Eröffnung/Ouverture*
Jean-François Braunstein *Historical Epistemology, Old and New*
Peter Schöttler *Sur la réception de l' "épistémologie française" en Allemagne*
Henning Schmidgen *Rheinberger's Take on Historical Epistemology*

CONTRIBUTIONS

Camille Limoges *L'épistémologie historique dans l'itinéraire intellectuel de Georges Canguilhem*
François Delaporte *La dissection humaine. De l'histoire des commencements à celle des origines*

Monika Wulz *Intervals, Possibilities and Encounters. The Trigger of a Ruptured History in Bachelard*

Thomas Ebke *The Rupture and the Screw. The Structure of History According to Georges Canguilhem and Helmuth Plessner*

Stefanos Geroulanos, Todd Meyers *Kurt Goldstein's Conception of Individuality*

Claude Debru *Georges Canguilhem. Épistémologie historique et/ou histoire philosophique?*

Pierre-Olivier Méthot *On the Genealogy of Concepts and Experimental Practices. Rethinking Georges Canguilhem's Historical Epistemology*

Françoise Balibar *Le concept d'objectivité chez Canguilhem*

Sandra Pravica *"Scientific Philosophies" in the Early 1930s and Gaston Bachelard on "Induction"*

Cornelius Borck *Canguilhem and Blumenberg. Working on the Evolution of Problems from Both Sides of the Rhine*

Andrea Cavazzini *Archéologie des concepts et philosophie de la nature*

Maria Muhle *Histoire(s) de la vie de Canguilhem à Foucault*

Cristina Chimisso *The Role of Scientific Ideology in Canguilhem's Historiography*

Frieder Otto Wolf *Ist eine historische Epistemologie der 'Sozialwissenschaft' möglich?*

Anselm Haverkamp *Life in Shakespeare's Sonnets*

The contributions are available as MPIWG Preprint 434.

Max-Planck Institut für Wissenschaftsgeschichte
Institut d'Histoire et de Philosophie des Sciences et des Techniques, Université de Paris1

Epistemology und Geschichte 9.–11. Dezember 2010

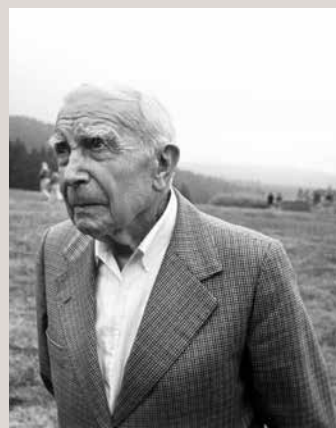
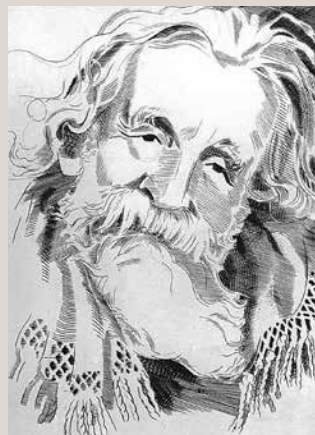

**Von Bachelard und Canguilhem
zur Wissenschaftsgeschichte von heute**

Historical and Biological Times

A Festschrift for Hans-Jörg Rheinberger

Madrid, February 24–26, 2011

This event was organized at the Instituto de Filosofía – Consejo Superior de Investigaciones Científicas, Madrid (Spain), by Ana Barahona, Christina Brandt, Carlos López Beltrán, Staffan Müller-Wille, Edna Suárez, and María Jesús Santesmases.

Program

February 24, 2011

Residencia de Estudiantes, Main hall

14.00 h Welcome

SESSION 1

14.30–16.00 h **Biology and Epistemology I**

Soraya de Chadarevian **History and Epistemology**

Michel Morange **Biology needs History and historians**

16.00–16.30 h Break

16.30–18.00 h **Biology and Epistemology II**

Richard Burian **On the Many Scales of Biological Time**

Carlos López-Beltrán **Exploring Heredity. Diachronic and synchronic narratives**

Open session

19.00 h **Biology and Philosophy** with *Hans-Jörg Rheinberger*

Discussants: *Matiana González* and *Miguel García-Sancho*

Residencia de Estudiantes, Main hall.

21.00. Workshop dinner: Residencia de Estudiantes

February 25, 2011

Centro de Ciencias Humanas y Sociales, Sala María Zambrano

SESSION 2

10.00–11.00 h **Variation and regulation**

Edna Suárez **Variation, differential reproduction and oscillation: The evolution of nucleic acid hybridization**

Christina Brandt **Híbrido Times: Reflections on the History of Cloning and Reprogramming**

11.00–11.30 h Break

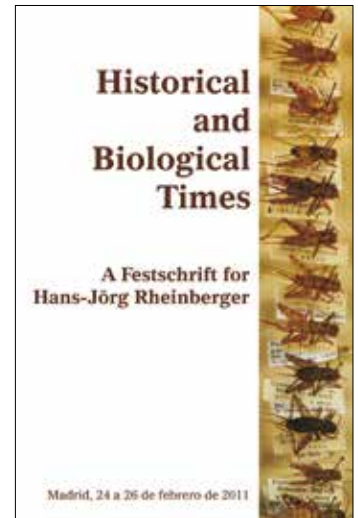

SESSION 3

11.30–13.00 h **Objects and tools**

Angela N. H. Creager ***Half-Lives: Reflections on Radioecology***

María Jesús Santesmases ***Biological landscapes: chromosomes of plants and human tissues***

Ilana Löwy ***The rise of the epistemic space of prenatal diagnosis***

14.00–15.30 h Lunch

SESSION 4

15.30–17.30 h **History and biology: the bench, the keyboard and the wardrobe**

Antje Radeck ***Personal experiences***

Bettina Wahrig ***Clocks with hands. Unruly times and the birth of chronos in obstetrics***

Hans-Jörg Rheinberger ***TBA***

20.00h. Dinner (TBA)

February 26, 2011

Residencia de Estudiantes, Main hall

SESSION 5

10.00–11.00 h Rewriting the times of biology I

Ineke Phaf-Rheinberger ***The New Atlantic History and its Relevance for the History of Science and Art***

Ana Barahona ***The history of genetics in Mexico in the light of the Cultural History of Heredity***

11.00–11.30 h Break

11.30–12.30h. Rewriting the times of biology II

Jean-Paul Gaudillière ***Listening to the difference: writing the history of molecular biology until its end***

Staffan Müller-Wille ***Reversion and Recapitulation: Nineteenth-Century Themes***

12.30–14.00 h General discussion + closing remarks

The contributions will appear as a volume of *History and Philosophy of the Life Sciences*: María Jesús Santesmases, Ana Barahona und Edna Maria Suarez Dias (Eds.): *Historical and biological times: A Festschrift in honour of Hans-Joerg Rheinberger*.

Digital Humanities

Overview

In the years 2010 to 2012, the focus of the IT group shifted from establishing workflows and tools for the provision of sources to developing the contextualization of data in the Semantic Web and new forms of publication. More broadly, the MPIWG contributes to the ongoing enterprise of bringing data together as part of the linked open data movement. This development has accelerated recently, with large projects like Europeana and the German Digital Library (DDB) moving in the direction of exposing data not only by means of websites in HTML but also as linked open data. The IT group, in close collaboration with the departments and the MPIWG library, has engaged with both practical results and theoretical analysis.

The IT group's daily workload is devoted to maintaining and improving the institute's digital library, keeping the basic infrastructure running, and assisting researchers. Increasingly, however, time has been well spent reorienting the general strategy of the group following the establishment of our core infrastructure in over the last few years. Now that a critical mass of available online sources has been created, researchers increasingly require tools to exploit the potential of the linked open data world.

The leading questions include the following: Which data models and formal languages should be used to integrate the existing heterogeneous data models? How can the models developed in the context of the Semantic Web movement be further developed to deal with research data? What role can ontologies and named graphs play in further digital representation of research in the humanities?

For example, the concept of a "Digital Scrapbook" has been developed (Jochen Büttner, Robert Casties, Jürgen Renn, Dirk Wintergrün), which has been intensively discussed with researchers within the MPIWG and presented externally at high-level digital project meetings. The ideas will serve as a guideline for an environment for interactive work with digital sources. The debates in the wider field now known as "digital humanities" show that the experiences in the humanities in critically reviewing data have helped the Web community to develop new standards of describing digital data. → p. 59

Innovative Forms of Publication

The first outcomes of the new orientation can be seen in "Edition Open Access", developed by Department I with the IT group (Jörg Kantel). This project establishes an exemplary workflow utilizing electronic sources provided by the ECHO infrastructure and language technologies developed in the context of the MPDL-MPIWG XML workflow project. This approach enables analysis of these sources to be integrated into a workflow for enriched electronic publication of secondary literature and print-on-demand. → p. 58
→ p. 55
→ p. 56

→ p. 57

An experimental but already impressive example of new forms of electronic publication is the publication of the manuscripts of Thomas Harriot (Jackie Stedall, Matthias Schemmel, Klaus Thoden, Dirk Wintergrün as part of the ECHO website. The Harriot project demonstrates an easy method for using classical analytical work on manuscripts in contextualization strategies of electronic sources within the linked open data world. Starting from a local analysis of the connectivity of folios of a manuscript, a global connected graph of the folios has been created. This process leads both to an easily understandable and navigable presentation of the manuscript on the Web and to a representation of the manuscript as a graph represented in RDF, on the basis of a simple manuscript ontology, making it possible to work on more complex questions about the connections between folios. Moreover, the references from the manuscript to the sources used by Harriot can be directly accessed online if digitally available either at the MPIWG digital library or externally at, for example, Gallica of the BNF.

Thomas Harriot's manuscripts as a network graph

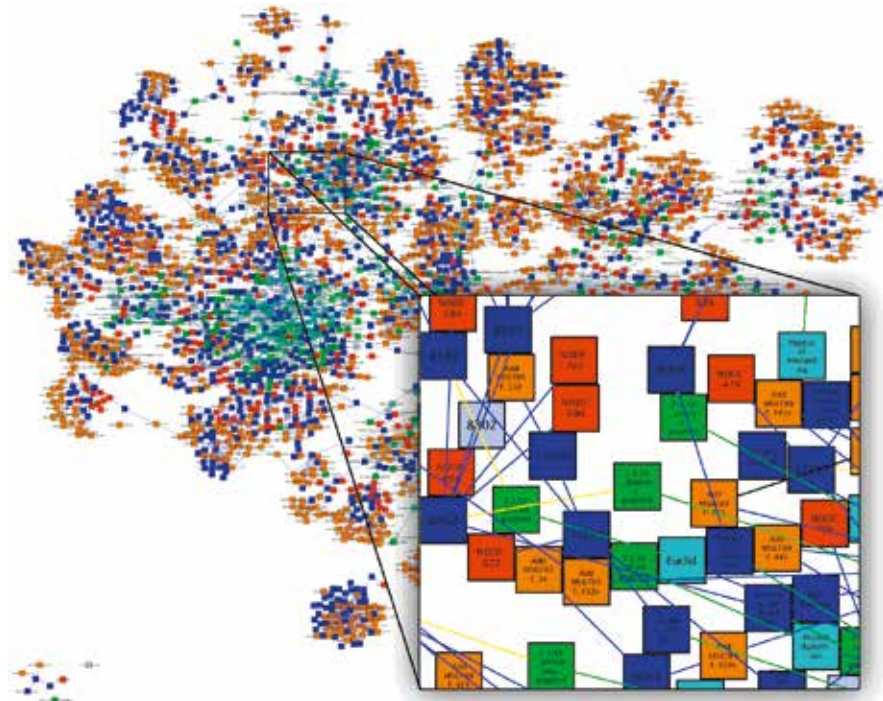

Geographical Information As a Starting Point for Data Integration

The handling of geographical information has been a growing topic of research in recent years. Easy ways of entering data referring to geographical information have been developed (Robert Casties, Falk-Juri Knauff, Dagmar Schäfer). The tempo-spatial browser E4D (which was developed by Europeana) has proved useful for visualizing the data from a project on maritime research on mammals, which contains both geographical and date information (Etienne Benson). The temporal-spatial browser is now being further developed in cooperation with DARIAH-DE in the context of the TOPOI project Atlas of Innovation, which began at the end of 2012. It also will be

→ p. 74

used to visualize the spread of manuscripts over time within duration of the ISMI project, which can be seen on an experimental website. It shows how data stored in a triple store and XML data can be integrated and then visualized on a map over a timeline (Etienne Benson, Dirk Wintergrün, Julia Damerow). This tool is also under evaluation for use in the future for the project on Big Science in the Archive (Elena Aronova).

→ p.74

From Singular Databases to Data Networks

Another approach to linked open data is based on the different database projects at the MPIWG. Although tailored to the needs of individual researchers, structural similarities enabled the development of general object models that can be used to describe the data for later reuse. This experience was brought to bear on the project Digitised Manuscripts to Europeana (DM2E).

The Islamic Scientific Manuscripts Initiative (ISMI) provides another example of how close collaboration between researchers and IT development contributes to the advancement of research in the field itself, and exemplifies strategic questions for the current Web infrastructure. In particular, data models had to be developed which permit the tracking of who contributed to a database and how data have changed over time, including the capability of keeping track of “errors” and misattributions. For example, it should be possible to retrieve information such as “This manuscript was formerly thought to be written by X, but it is now attributed to Z.” The importance of describing database entries as events in specific causal and hence temporal relations became clear. This concept is very close to the basic ideas of CIDOC-CRM, the ontology for describing museum data, which indicates that it could be a good basis for an ontology describing historical data in the wider domain (Robert Casties, Jorge Urzúa).

→ p.101

The data models developed in the ISMI project and the technologies for transcribing and displaying manuscripts used in the Harriot project have been reused in setting up the research environment for the project “From Cennini to de Mayerne: Artists’ Recipes for Painting Materials and Techniques, 1400–1650”. The database University Women’s International Networks Database (Christine von Oertzen, Ulla Drenkhan) demonstrates the flexibility of existing tools available at the MPIWG for bringing data in the Net; it shows how research data in a linked open data world can be used immediately to improve available reference data compiled elsewhere, by linking persons immediately by means of their identifiers.

→ p.174

Another starting point for developing data integration strategies is the reformulation of the data of the Duomo project from XML and SQL-like data into RDF based on an ontology which is then related to CIDOC-CRM. First results show that the use of CIDOC-CRM, in particular the underlying concept of events, can be a solution for creating “reusable data” (Günther Görz, Dirk Wintergrün).

→ p.27

To ensure long-term access and interoperability, we aim to provide additional descriptive data in RDF or—wherever possible—to reformulate the existing databases into RDF. The goal is to expose all data via a SPARQL endpoint. Currently, experimental versions of the Duomo database, the data of the Harriot project, and the insti-

tute's online sources can be queried via SPARQL. The underlying experimental ontologies in OWL are also available over the institute's triple store. Stable URIs for the digital object of the institute's resources have been introduced. Gradually, key data objects will be assigned stable URIs, which can then be retrieved either as RDF data for further processing or as HTML pages for the end user. To ensure interoperability, we are investigating how the ontologies for our research databases can be related to more general concept ontologies such as CIDOC-CRM. Mappings to the Europeana Data Model are currently under development in order to integrate the institute's data in the Europeana Data Space. This work is undertaken as part of the DM2E project.

By generalizing data structures and adding controlled vocabularies wherever possible, research data can be used immediately either to enrich the data collected by libraries or as part of encyclopedic projects. Thus, the dividing line between the generation of reference works and the pursuit of current research on a specific topic in the humanities can be crossed without weakening the difference between these two aspects of research.

Discussions in the DM2E project and in the context of DARIAH, TextGrid, and the DigitalHPS consortium show that extensions of the existing Semantic Web standards are still necessary in order to encode scholarly research data and thus ensure the high standards of scientific publications. In particular, the provenance of information in the data cloud has to be traceable, and different opinions about one information unit and its versions have to be established. Recent developments in how to use named graphs as an extension of existing Semantic Web standards take up this issue, and there is reason for hope that significant progress will be made in the coming years. The goal is to have all of our data become part of the linked open data cloud by the end of this process.

Viewing, Searching, Annotating

The MPIWG viewing environment for electronic sources has been significantly improved. The front end and the back end for the display of full texts and images have been renewed, integrating the efforts of the XML workflow project, ECHO and optical character recognition (OCR) technologies previously developed, and new annotation tools for images and XML texts. Annotations are stored on the institute's annotation server and can be shared for use in working groups. The next step will be an exposition of the annotation data following open linked data standards as part of the Digital Scrapbook project.

All digital objects in the institute's library catalog and the institute's bibliography are now available in a single search environment. This environment also enables full text searches in the documents which went through the OCR workflow.

New Infrastructure

A new architecture for the institute's infrastructure is being developed which integrates our technological developments to date. It rests on two pillars: source provision by the ECHO infrastructure, and the publication of secondary literature and data on the basis of ideas developed by Edition Open Access. These pillars are interconnected by interactive tools based on the Digital Scrapbook.

→ p. 59

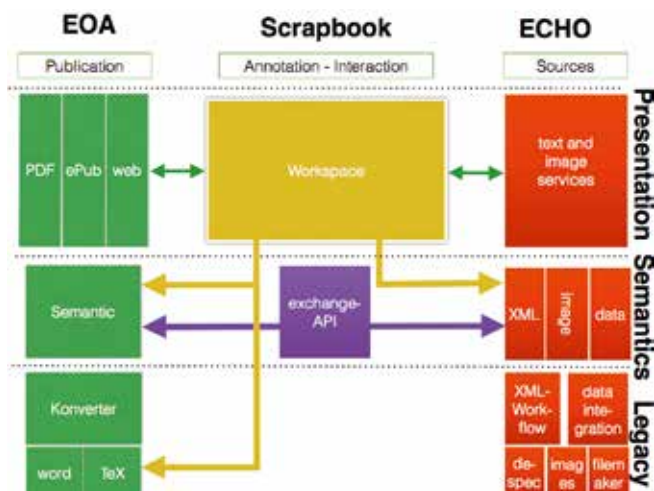

Integrated IT infrastructure of the MPIWG

Outreach

The task of the IT group at the MPIWG as a scholarly research unit is to combine work on time-limited research projects with the long-term provision of online data. For this reason, the strategies to be followed differ significantly from digital projects at universities, where short-term success is often the main focus on account of limited funding. Since the beginning, the goal of the IT group has been to keep digital output from projects at the MPIWG accessible even after the end of a project. This goal is a basic condition for the establishment of digital publications as scholarly works equal to printed articles and monographs.

The institute's IT group collaborates with other research institutes, academic libraries, and projects at universities within the BMBF-funded TextGrid project and the EU project Digitised Manuscripts to Europeana (DM2E), and since December 2012 has taken a leading position in DARIAH-EU (Dirk Wintergrün). The IT group also supports the library to integrate the institute's resources into the Online Portal of the German Digital Library. Initiated by partners of the TextGrid project, the MPIWG hosts the German Digital Humanities Blog. In Berlin, close collaboration on the working level has been established with the IT group at the Berlin-Brandenburg Academy of Sciences and Humanities, and informal meetings with the German Archaeological Institute (DAI) have taken place. A working cooperation has also been established within the TOPOI project Digital Atlas of Innovations.

→ p. 47

Through these partnerships and collaborations, the MPIWG now plays a significant role in the development of the exciting new field of "digital humanities" in the national and the international context.



Library

by *Urs Schoepflin*, Library Head

Overview

The Library's mission is to provide the best-possible information services to the MPIWG research groups and to create optimal access to both print and electronic resources. It aims to develop effective services and infrastructures for research in the history of science by exploiting the potential of traditional and new media for scholarly work and for disseminating research results.

With the rapidly growing importance of scholarly content that is available online, libraries — building on their strengths and expertise in collection building and dissemination — are shaping new roles and practices in a way that allows the scholarly communication supply chain to continue to function effectively. Supporting the open sharing of content and data has become another crucial library activity.

To meet the evolving needs of the existing research groups at the MPIWG and to integrate new groups, particular attention was given to the following key areas: (a) further development of the collections, content provision, and services; (b) enhanced acquisition and curating of digital content and sources, and development of appropriate access systems; (c) support of scholarly publication and dissemination activities by copyright clearing services and additional publication aids, with a special focus on implementing the Max Planck Society's open access policy; and (d) extension of the collaborative network of the MPIWG Library through outreach activities.

The Library thus continues to develop into a universal information instrument dedicated to the widespread needs of a multidisciplinary research area and prepared to flexibly master new bodies of knowledge as new research directions and themes appear.

The Library's Collections and Services

The MPIWG Library collections currently hold 70,000 volumes in print as well as over 25,000 historic works and materials in microform. In addition to the systematic collection building policy in accordance with scholarly needs, as in past years the print collection has benefited from special book collections endowed to the Library, in particular items from the private libraries of Max Born and of Peter Damerow. These unique collections are of particular interest because they reflect the special approach of the collector or the collecting body to specific thematic areas relevant to research at the MPIWG.

In addition, original archival resources contain some 10,000 items, primarily papers by physicists of the first half of the twentieth century (e.g., the Gehrcke collection, Rupp correspondence, and Einstein letters), the majority of which are made available in digital form. Recently, the Gehrcke collection was complemented by further items, and it now constitutes the most important collection of Gehrcke materials.

Access to electronic resources includes over 30,000 electronic journals, more than 200 full-text and reference databases, and a number of e-book collections largely as a result of the basic information provision of the Max Planck Digital Library (MPDL) and the ongoing National Licensing Program of the German Research Foundation (DFG).

Complementing these holdings and resources, the interlibrary loan service has been in high demand and has maintained a level of between 10,000 and 12,000 loans per annum. This particular service priority of the Library allows for rapid document delivery, providing books and articles from a wide network of national and international research libraries within days of a scholar's request and responding flexibly to new thematic user needs. Thus, the Library represents a central node of an information network — currently extending to the holdings of well over 500 individual libraries worldwide — that flexibly brings together information from a wide range of relevant sources and makes content available to scholars at the MPIWG and at its collaborative research centers.

Addressing the need for further distribution of catalog information, library catalog entries are uploaded to the union catalog of the Max Planck libraries vLib, a major database for research literature in Germany. In addition, the data will also be openly available as Linked Open Data, allowing for direct linking and reuse.

Digital Research Library and Acquisition of Digital Content and Sources



Commandino Manuscript 121-2, Urbino University Library



Access to digital sources and other materials has become crucial for research in the history of science. To address this issue, the MPIWG Library has unfolded a multi-layer strategy to enhance acquisition and access to digital content and sources. The strategy includes the following elements.

The special program for digitizing and presenting sources in the history of science in high-quality color facsimiles from the Library's rare books collection and in greyscale images from the microform archive has been further developed. All digitized materials are made available in a Web-based Digital Research Library. The program includes the establishment of a special digitization group within the Library which is equipped and qualified to digitize material at a high professional standard at a rate of 500,000 pages per annum. The workflow comprises procedures to upload the resulting images to the online presentation environment of the Digital Research Library and to securely archive the master files. The service is designed to flexibly react to new demands in the short term. The program is working closely with the research groups at the Institute which present their research on the Internet so that they can immediately integrate the digitized sources in their presentation.

The ECHO open access infrastructure (<http://echo.mpiwg-berlin.mpg.de>; ECHO – Cultural Heritage Online; for a statistical overview, see Department I) has become the Institute’s key instrument for uploading and openly presenting sources on the Internet and at the same time for offering scholars appropriate tools to work with the digital sources. It is a widely renowned flagship repository for historic material.

To maintain it at a high level of performance, the Library, together with the IT Group, is further developing the ECHO infrastructure and its functionalities, focusing on the integration of tools developed by the IT Group and the XML Workflow project in the framework of activities in the Digital Humanities. The Library maintains the central repository of metadata of all digital objects created at the institute, including consistent information on copyright and permissions through the systematic attribution of Creative Commons licenses.

ECHO materials and other digital objects of the MPIWG will also be exposed to a larger audience through the German Digital Library (Deutsche Digitale Bibliothek). In the recently launched initial phase, more than 1,000 of these digital objects are presented together with materials from a wide range of cultural institutions. In the future, the material will be uploaded and made available to an even larger international audience through Europeana.

The multitude of content created internally by the research groups at the institute and the exponentially growing number of external online resources require solutions that go beyond the traditional means of handling information. Together with the IT Group, the Library is working on a search environment that will concentrate initially on the central metadata repository of all digital objects, the library catalog, preprint series, PubMan, archival resources, data from ECHO and from other research databases at the MPIWG, and data resulting from full-text conversion. For the first time, easy access to these highly focused resources will be possible through a single search environment.

The Library’s investment into professional mobile digitization equipment and expertise for systematically digitizing source materials on remote sites yielded in digitization campaigns in institutions or in private collections. During the report period, campaigns were deployed at such locations as the Bibliotheca Olivierana in Pesaro, Italy; the Urbino University Library (archival materials of Guidobaldo del Monte and of Federico Commandino); and the Centro Internazionale di Studi Rosminiani in Stresa, Italy, for manuscripts of Bernardino Baldi. With these Baldi materials digitized, it is possible for the first time to directly compare the materials with Baldi manuscripts in the History of Science Collection of the Oklahoma University Library or in the Dibner Library at the Smithsonian Institution.

Digitization campaign in Stresa, Italy



The digitizing of the Hilprecht Archive and Cuneiform Collection at the Friedrich-Schiller-Universität Jena was continued (also through the use of 3-D scanning, in cooperation with the university and Department I). The Library also oversees the digitization of the collection of Arabic manuscripts at the Berlin State Library (in cooperation with the ISMI project at McGill University, Montreal).

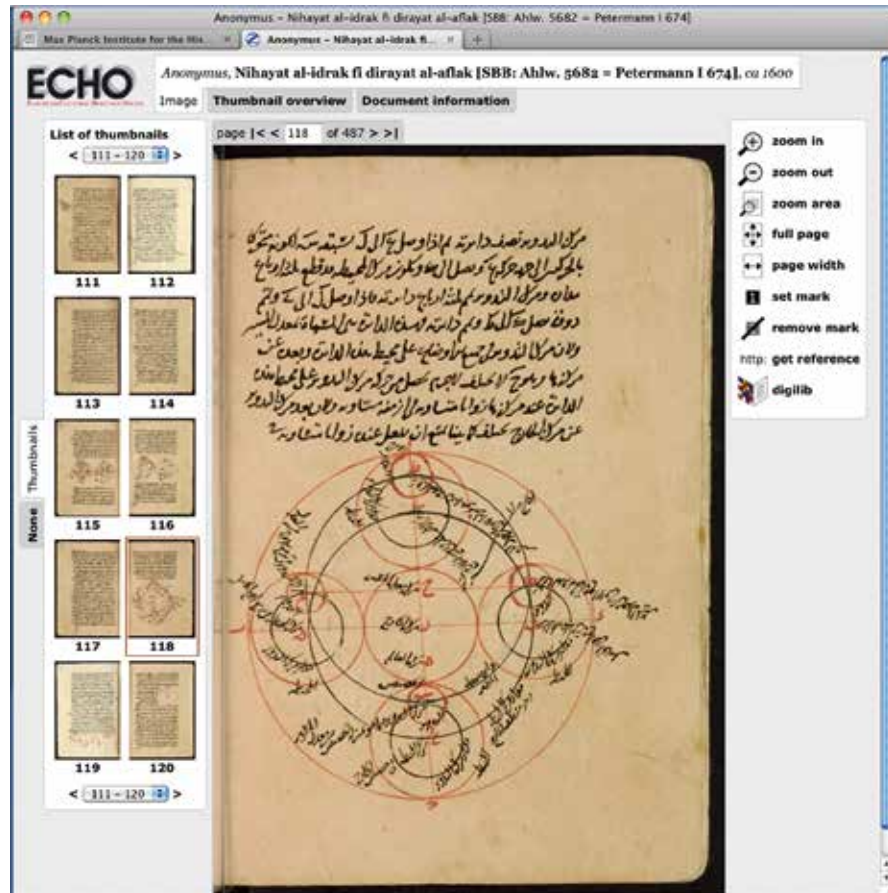

Arabic Manuscript Ahlw. 5682, Berlin State Library

Further digitization is planned for the Harriot manuscript collection held by Lord Egremont at Petworth House, West Sussex, United Kingdom, which will significantly enhance the Harriot collection already available in ECHO.

To expand the scope of the available digital sources, the MPIWG Library has negotiated several cooperation contracts with institutions holding relevant material and commissioned its digitization. A key issue in the agreements is to obtain permission to use the digitized materials freely and openly on the Internet for our scholarly purposes. Digitization agreements for the following source corpora have been negotiated: the correspondence of the French astronomer Joseph-Nicolas Delisle held at Bibliothèque de l'Observatoire, Paris; and the complete cuneiform clay tablet collection held at Vorderasiatisches Museum, Berlin, a rich collection which will complement the major museum collections already in the Cuneiform Digital Library Initiative (CDLI).

The Library has continued to acquire and make available archival materials as major research resources, and thus represents an innovative model of how to make archival materials immediately accessible to the research groups at the MPIWG and their international cooperation partners. The digitization of the complete microfilms of the Archive for the History of Quantum Physics has been completed, and for the first time allows for full electronic access to the material. It constitutes a decisive scholarly resource for the international project group on the History of Quantum Mechanics. A further collaboration on archival materials of twentieth-century physics is being discussed with the American Institute of Physics and with the Archive of the Max Planck Society.

In addition to digitization at image level, the Library is involved with the workflow of primary text acquisition and XML structuring to support XML annotations and lexical analyses performed on historical texts on, for example, mechanics. This work is performed in cooperation with the IT Group and the XML-Workflow project, a group funded by the MPDL and hosted at the MPIWG. The Library's workflow includes commissioning transcriptions of texts to Chinese companies specializing in transcribing texts from old Western prints as well as in classic Chinese.

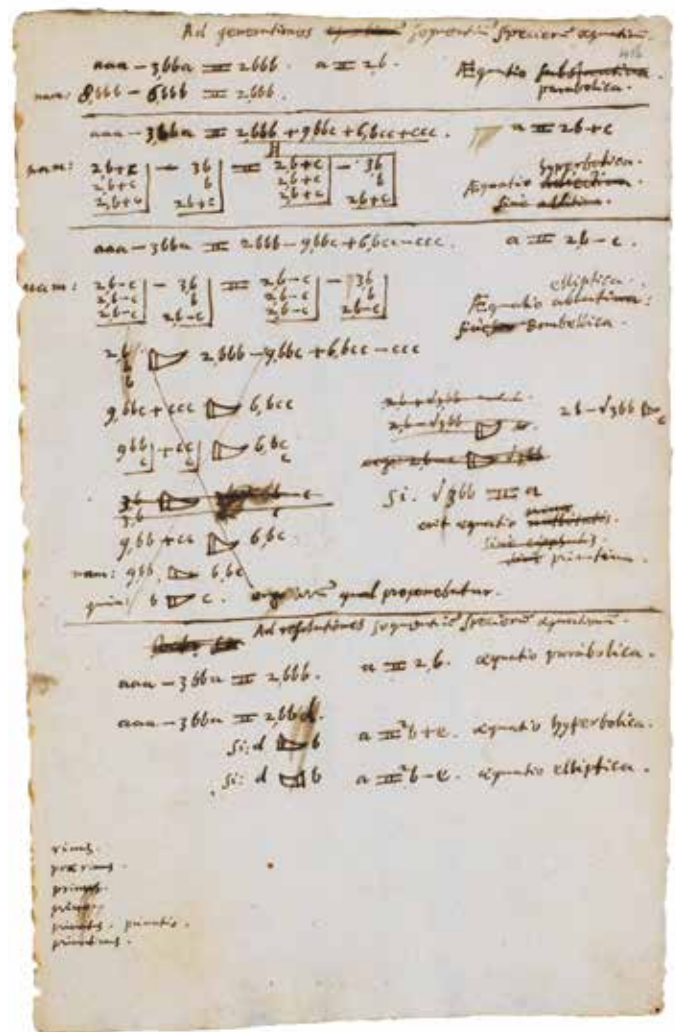

Harriot Manuscript 6784, British Library

Support of the Scholarly Publication and Alternative Dissemination Process

Research results of MPIWG members are disseminated in print as well as in electronic form. To give the authors adequate support in dealing with copyright issues, transfer agreements, and publisher contracts, the Library has established a copyright clearing service and offers advice to authors on publisher contracts and copyright transfer agreements. To open up new fields of research and to approach topics from a comparative perspective — both challenges that invite collective rather than individual scholarship — many MPIWG research projects publish their principal results in the form of a collective printed Working Group Book.

The limitations and rising costs of the traditional means of disseminating results through commercial publishers are becoming increasingly salient, and novel means of dissemination that are more adequate to research needs are being sought. The Max Planck Society is committed to the principle that findings of fundamental research should be accessible to all. In 2003 the Society publicly demonstrated its commitment

to open access by initiating the “Berlin Declaration on Open Access to Knowledge in the Sciences and the Humanities” (see < <http://oa.mpg.de/lang/en-uk/berlin-prozess/berliner-erklarung/> >). Pursuing this policy to make available as many research results on the Internet as possible, the Library took responsibility for uploading the Institute’s bibliography and publication output (metadata and documents) to the PubMan server. On this server, the searchable bibliographic data and — depending on the individual authors’ agreements — the full text of the research results, presentations, and so on, are made available for either internal or open use. Data curating throughout the life cycle of the documents is also part of the Library’s responsibility. To foster an awareness and acceptance of open access publishing, the Library offers guidelines for MPIWG scholars, which provide information about the open access process, electronic publishing on the repository, legal issues, copyright transfer agreements, and recommendations on what rights to retain.

→ p. 58

With Edition Open Access (<<http://www.edition-open-access.de>>), a major desideratum for open access publishing of monographs is addressed. The Library is actively involved in developing the concept, and in negotiating and providing access to sources to be included in the edition. Funding opportunities are being sought in order to continue expansion of the edition. In the framework of the commented source series, a close collaboration with the History of Science Collection of the Oklahoma University Library, Norman, is planned in order to share the digitizing of rare books.

Urs Schoepflin follows up closely on the international implementation of open access, and he is actively involved in the annual “Berlin Process” conferences of the signatories of the Berlin Declaration.

Outreach Activities

The Library has been involved in several collaborative projects. The two foremost aims of cooperating with research and cultural institutions are, on the one hand, the sharing of rare and manuscript materials to enhance access to these resources for research purposes and, on the other hand, the transfer of skills by sharing expertise in

maintaining digital projects in order to make these resources available on the Internet. For the Max Planck Society, cooperation with both the Bibliotheca Hertziana (the Max Planck Institute for Art History in Rome) and the Kunsthistorisches Institut in Florenz (the Max Planck Art History Institute in Florence) is particularly relevant in these respects.

In a number of international cooperation agreements, the Library’s expertise in digitizing and in making cultural heritage materials available on the Internet was involved. The Library is working intensively with MPIWG’s partners at the Institute for the History of Natural Sciences at the

Berlin 8 Open Access Conference Beijing 2010



Chinese Academy of Sciences in Beijing in digitizing collections, which includes advisory meetings and training sessions in Beijing and Berlin.

In the framework of several delegation visits to Mongolia on behalf of the Max Planck Society, the library has installed equipment for the Competence Center for Digitizing Cultural Heritage at the Mongolian Academy of the Sciences (MAS) in Ulaanbaatar, with the support of the Max Planck Society. The necessary infrastructure was installed, and advisory meetings and training sessions for Mongolian scholars were held in Ulaanbaatar and in Berlin. The results of the pilot phase were shown at a joint MPG-MAS conference in Berlin.

→ p. 49

The Library's key concepts are presented in many different ways. In particular, the basic ideas are conveyed during several expert visits from Germany and from abroad. With its involvement in library education, the Library is assuming another responsibility: it offers internships on a regular basis to students in library and information science who are preparing for a career in modern library management. This program has proved an efficient means to transfer our concepts into library education, a fact which is reflected in subsequent master and diploma theses. In addition, Urs Schoepflin regularly gives presentations at Berlin universities, the Berlin State Library, and professional meetings. He also was invited for talks and lectures on ECHO and on open access publishing at the Center for Advanced Study in the Visual Arts, Washington DC; at Caltech for the Einstein Papers Project; at Indiana University Bloomington; at the Biblioteca Leonardiana in Vinci; and at Cold Spring Harbor for a conference on future directions for research libraries.

As a member of the Expert Advisory Board of the German Digital Library (Deutsche Digitale Bibliothek), Urs Schoepflin advises on its development from a scholarly perspective.

Finally, the Library is actively involved in the discussions on the concept of the Max Planck Digital Library (MPDL). This strategic cooperation with the MPDL will provide the necessary support for further generalizing and maintaining the services developed at the MPIWG, and will also help integrate new services and secure long-term availability and archiving of the scholarly results in a reliable and stable environment so crucial to research.



Library Team
left to right: Urs Schoepflin,
Ellen Garske, Ruth Kessentini,
Sabine Bertram, Ralf Hinrichsen,
Urte Brauckmann, Anke Pietzke,
Beate MacPhail, Matthias Schwerdt

Cooperation and Outreach

Cooperation with Universities in Berlin: Developments and Prospects

Over the last five years, the teaching and research landscape of the history of knowledge and science in Berlin has been transformed. The 2007 Cooperation Agreement between the Humboldt-Universität zu Berlin (HU), the Freie Universität Berlin (FU), and the Max Planck Society (MPG) was expanded in 2011 to include the Technische Universität Berlin (TU), leading to the creation of new professorships at the universities and new positions as research group director at the Max Planck Institute for the History of Science (MPIWG). In addition, Berlin's three major universities have appointed other leading scholars in areas related to the history of science and knowledge to professorships in faculties ranging from ancient history to art history. With the quantity and quality of scholars now based in Berlin, the city offers a unique opportunity for cooperative research. The aim of the four partner institutions is to exploit this potential through a significant expansion of activities, a considerable strengthening of institutional ties, and a long-lasting consolidation of heretofore dispersed resources in Berlin.

In particular, since 2010 the MPIWG has established strong collaborations with the universities in hiring new Max Planck Research Group Directors. Professor Veronika Lipphardt, who in 2009 launched the research group "Historicizing Knowledge about Human Biological Diversity in the 20th Century," was appointed S-Professor for the History of Life Sciences at the FU in the spring of 2010, and has resumed her teaching obligations at the Friedrich-Meinecke-Institute at the FU. In a joint selection process with the Faculty of the Humanities at the FU, Professor Sven Dupré was appointed new Max Planck Research Group Director. He successfully launched the research group "Art and Knowledge in Pre-modern Europe" in the summer of 2011 at the MPIWG. He was appointed S-Professor for the History of Knowledge in the fall of 2011 and is affiliated with the Institute for Art History at the FU. Both Professor Lipphardt and Professor Dupré teach one course per semester. A third Max Planck Research Group leadership position will be advertised in the winter of 2012/13. A joint search committee of the MPG and the HU will organize the selection process in 2013, with the intent of awarding the successful candidate with a professorship from the HU. This position will match the appointment of Junior Professor Phillip Felsch for the History of the Human Sciences at the Cultural Studies Institute (HU), a position that was created through the Cooperation Agreement. The cooperation advisory board, whose members were named by the presidents of the universities, actively supported these developments.

These efforts to make a long-lasting impact on institutional structures are complemented by a number of initiatives to foster dialogue between researchers based in Berlin, with a focus on doctoral students and postdoctoral researchers. The MPIWG has co-organized a number of doctoral workshops that bring together researchers from the MPIWG and doctoral students from Berlin's major universities: for example,

the “Studientag Literatur and Wissenschaftsgeschichte” took place in 2012 for the seventh time, organized together with Professor Jutta Müller-Tamm (chair for New German Literature, FU). A new endeavor is the “Berliner DoktorandInnenforum für Wissensgeschichte,” which brings together doctoral students from the three universities, four university professors, and the Max Planck Research Groups. Researchers at the MPIWG also participated in a successful DFG grant application for the postdoctoral network “Auditory Knowledge in Modernity: An Epistemic History of Listening,” which includes scholars from the MPIWG, the FU, the HU, and other universities in the United States, the Netherlands, Switzerland, and the United Kingdom.

Creating new pathways to research and teaching in the history of science in Berlin has further strengthened other aspects of cooperation in Berlin. Most notably, in the spring of 2010 the cooperation partners began compiling an annotated list of all courses that are offered at the Berlin universities in the field of the history of knowledge (“Berliner Vorlesungsverzeichnis Wissenschaftsgeschichte”). Coordinated by the MPIWG, the editorial board of the four partner institutions meets once a term to select appropriate courses. The printed version of the course list has a circulation of four hundred copies (average number of entries per semester: 137). It also appears online on the newly launched website www.wissensgeschichte-berlin.de. Aimed at interested researchers and students in Berlin, this website provides a wide range of helpful information to researchers with a primary interest in the history of knowledge, as well as a calendar of events in Berlin. It will be expanded to include, for example, an online doctoral forum.

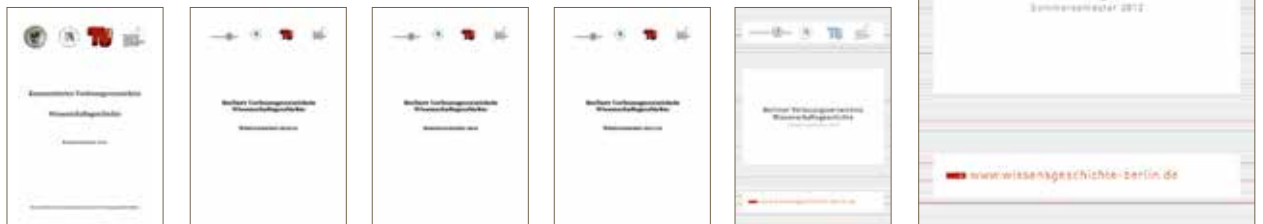

Each semester, the Berlin cooperation partners publish a commented course list that indexes all relevant seminars and lectures taught in the history of knowledge at the Berlin universities.

Since 2010, the Berlin cooperation partners maintain a website with information on courses and events in the history of knowledge as well as a guide to scholars working at various Berlin institutions

In the context of these recent developments, the partner institutions are working on the establishment of a Berlin Center for the History of Knowledge. The central goal of the Berlin Center is to develop the potential of Berlin's unique scholarly resources by regularly bringing together Berlin's scholars as well as colleagues invited from other institutions. These scholars will realize common projects and contribute to reflection on the foundations of the academic field of the history of knowledge. In the first expansion stage and with the support of the universities, the MPIWG successfully applied in 2011 for funding from the Innovation Fund of the President of the Max Planck Society to create the Max Planck Research Network "Towards a History of Knowledge: Generation, Legitimation, Globalization." This starting grant will be matched by significant contributions from the universities and will be used to establish a number of postdoctoral fellowships in 2013. These newly hired postdoctoral scholars will function as an important link between the institutions by establishing working groups and organizing workshops. This basic stage of the Berlin Center is set to run for five years and will integrate the work of university faculty members, MPIWG researchers, doctoral candidates, and postdoctoral scholars on central themes such as legitimation, globalization, and generation. As a forum for new research endeavors and as a platform for public discussion, the Berlin Center will increase the visibility of Berlin's multidisciplinary research potential in the history of knowledge.

Members of the Board of the Cooperation Agreement since 2011

HU	Philipp van der Eijk, Gerd Graßhoff, Anke te Heesen, Hildegard Nickel
FU	Peter Geimer, Mark Geller, Jutta Müller-Tamm, Wilhelm Schmidt-Biggemann
TU	Günter Abel, Hans Christian von Herrmann, Wolfgang König, Friedrich Steinle
MPIWG	Lorraine Daston, Jürgen Renn, Sven Dupré, Veronika Lipphardt

Outreach Activities of the Institute

GLOBALER WISSENSTRANSFER UND GLOBALISIERUNG DES WISSENS / GLOBAL TRANSFER OF KNOWLEDGE AND THE GLOBALIZATION OF KNOWLEDGE

Das Max-Planck-Institut für Wissenschaftsgeschichte in Kooperation mit dem Forum Transregionale Studien

23. APRIL 2012	24. MAI 2012	19. JUNI 2012	10. JULI 2012
TRANSLATION AS GLOBAL TRANSFER OF KNOWLEDGE	INDIVIDUALS AS ACTORS OF TRANSFER OF KNOWLEDGE	TRANSFER OF KNOWLEDGE IN SYSTEMS	INSTITUTIONS AND THE TRANSFER OF KNOWLEDGE
Yehuda Elkana Berlin	Andreas Eckert Berlin	Marianne Braig Berlin	Matthias Middell Leipzig
Mark Geller Berlin	Matthias Schemmel Berlin	Joos Braarvig Oslo	Chrus Raana New Delhi/Berlin
Richard Rottenburg Halle-Wittenberg	Sonja Brentjes Berlin	Derd Grathoff Berlin	Viola König Berlin
Michael Allan Eugene/Berlin	N. N.	N. N.	Pietro Daniel Omodeo Berlin

Das Max-Planck-Institut für Wissenschaftsgeschichte in Kooperation mit dem Forum Transregionale Studien lädt ein

GESPRÄCHSABENDE / SERIES OF DISCUSSIONS

Alle Abende finden statt um 19 Uhr im Konferenzraum des Max-Planck-Instituts für Wissenschaftsgeschichte
Boltzmannstraße 22, 14195 Berlin, U-Bahnhof Tiergarten, www.mpgwg-berlin.mpg.de

Public Events

Poster of a series of panel discussions that were jointly organized by the MPIWG and the Forum Transregionale Studien in the spring of 2012. In four sessions of discussions, scholars from different disciplines focused on the long history of the globalization of knowledge. The sessions pursued questions such as how transfer of knowledge was achieved, which kinds of media were involved, and in which spaces such processes took place. This project was coordinated by Helge Wendt as part of the project “Globalization of Knowledge” (Department 1).



Left: Poster of a public panel discussion on “Life Sciences Today: Permanent Revolution or Old Questions in a New Outfit?” This talk took place at the MPIWG on October 20, 2010, and was organized in cooperation with Suhrkamp Verlag. Participants included Hans-Jörg Rheinberger, Helga Nowotny (European Research Council), Giuseppe Testa (Laboratory of Stem Cell Epigenetics at the European Institute of Oncology in Milan), Staffan Müller-Wille (ESRC Centre for Genomics in Society, University of Exeter); it was moderated by Andreas Sentker (of the national weekly newspaper *Die Zeit*).

Right: Poster of the final symposium of the Research Network “History of Scientific Objects” on “Weltwissen der Dinge – Wissenschaftsgeschichte am Objekt,” which took place in cooperation with the exhibition *WeltWissen: 300 Jahre Wissenschaften in Berlin* at the Martin-Gropius-Bau, October 4–5, 2010.

MPIWG in the Media

Researchers at the MPIWG have appeared regularly on international, national, and local media between 2010 and 2012 (number of appearances: 102). They have been invited to participate as experts on historical and recent developments in the sciences; they have participated in radio interviews and appeared in news and topic-driven television programs; their work has frequently been cited in newspaper articles; their books were reviewed in high-circulation journals; they received public recognition in special portraits of their projects; and they contributed work as authors. Media have included Deutschlandfunk, DeutschlandRadio Kultur, DeutschlandRadio Wissen, RBB/InfoRadio, Frankfurter Allgemeine Zeitung, Tagesspiegel, taz, Der Standard, NRC Handelsblad, Corriere della Sera, MaxPlanckResearch, Times Literary Supplement, Nature, Cicero, Deutsche Welle TV, and Arte.

Media Appearances, 2010–2012 (Selection)

Entries with * indicate authorship by an MPIWG researcher

Newspapers

“Das Gehirn ist kein Muskel”; Nicolas Langlitz on brain-doping; *Frankfurter Allgemeine Zeitung*, January 11, 2010.

* “Was bleibt vom Darwin-Jahr 2009?”; Hans-Jörg Rheinberger on the aftereffect of Darwin Year 2009; *Frankfurter Allgemeine Zeitung*, April 7, 2010.

* “Von der Physik zur Weltanschauung und wieder zurück”; Milena Wazeck on Arne Schirrmacher’s book “Philipp Lenard: Erinnerungen eines Naturforschers”; *Frankfurter Allgemeine Zeitung*, May 31, 2010.

“Streit um Mendels Manuskript”; Hans-Jörg Rheinberger interviewed in the context of the controversial ownership of Gregor Mendel’s manuscript “Versuche über Pflanzenhybriden”; *Der Standard*, June 9, 2010.

* “Die Bequemlichkeit des Erbes”; Veronika Lipphardt on biological determinism; *Der Freitag*, September 25, 2010.

* “Gestanzte Daten der Bevölkerung: Die Urgeschichte der Lochkarte”; Christine von Oertzen (with Keith R. Allen) on the history of punch cards used for census-taking; *Frankfurter Allgemeine Zeitung*, November 24, 2010.

* “Der Einstein-Verein”; Dieter Hoffmann on the history of the Kaiser Wilhelm Society; *Tagesspiegel*, January 9, 2011.

“Auferstehung des Fleisches als klassische Form”; report on the workshop “Immortal Bodies” at the Max Planck Institute for the History of Science; *Frankfurter Allgemeine Zeitung*, January 19, 2011.

“Diskussion um Debye”; article on a symposium on Peter Debye in Göttingen, and Dieter Hoffmann’s book “‘Fremde’ Wissenschaftler im Dritten Reich”; *Göttinger Tageblatt*, April 27, 2011.

“Antike-Kolleg: Exzellente Forschung in Berlin”; article on the opening of the Berliner Antike-Kolleg; *Frankfurter Allgemeine Zeitung*, May 11, 2011.

“Gedankenblitze aus der Zettelwirtschaft”; review of the edited volume “Geschichte als Passion,” including interviews with the historians Lorraine Daston and Hans-Jörg Rheinberger; *Frankfurter Allgemeine Zeitung*, May 13, 2011.

“Von der Keilschrift bis zur Quantenphysik”; article on the Max Planck Institute for the History of Science, including an interview with Jürgen Renn; *Tagesspiegel*, May 21, 2011.

“Hoe kennis onderweg verandert”; interview with Jürgen Renn; *NRC Handelsblad*, June 1, 2011.

* “Krumme Wege der Vernunft”; Jürgen Renn and Fynn Ole Engler on Ludwik Fleck; *Frankfurter Allgemeine Sonntagszeitung*, June 5, 2011.

“Gefeiert und herumgereicht”; Dieter Hoffmann commenting on the Nobel laureates Albert Einstein and Rabindranath Tagore; *Potsdamer Neueste Nachrichten*, July 13, 2011.

* “Keine Begeisterung beim Hitlergruß”; Dieter Hoffmann on the physicist Peter Debye; *Frankfurter Allgemeine Sonntagszeitung*, July 31, 2011.

- * “Physiker und Pianist”; Dieter Hoffmann on the deceased physicist and Nobel laureate Rudolf Mößbauer; *Tagesspiegel*, September 20, 2011.
-
- “Wovon der Prachtleierschwanz singt”; book review of the Festschrift for Hans-Jörg Rheinberger; *Süddeutsche Zeitung*, November 8, 2011.
-
- “Anassilaos, cultura d’esportazione”; on the honoring of Jürgen Renn with the “Premio Anassilaos International” 2011; *il Quotidiano*, November 13, 2011.
-
- * “Wer nicht das Gleiche glaubt, ist auszurotten”; Dieter Hoffmann on Werner Heisenberg and Carl Friedrich von Weizsäcker; *Frankfurter Allgemeine Zeitung*, November 16, 2011.
-
- * “Der Stoff der Psychoanalyse”; review by Andreas Mayer; *Frankfurter Allgemeine Zeitung*, January 2, 2012.
-
- “Die neue Dimension des Unheimlichen”; Hans-Jörg Rheinberger (with Horst Bredekamp) on synthetic biology; *Tagesspiegel*, January 13, 2012.
-
- “Tranken die Sumerer Bier?”; on Peter Damerow’s research; *Bremer Nachrichten*, January 21, 2012.
-
- “Kritisches Hirnfunkeln”; review of the editions “Critical Neuroscience” (eds. Suparna Choudhury and Jan Slaby) and “Neurocultures” (eds. Fernando Vidal and Francisco Ortega); *Frankfurter Allgemeine Zeitung*, June 13, 2012.
-
- “Gebt den Seidenraupen Brennesseln”; on big data in biology and Staffan Müller-Wille’s (with Isabelle Charmantier) article on “Natural History and Information Overload” (in: *Studies in the History and Philosophy of Biological and Biomedical Sciences*, 43/1 (2012)); *Frankfurter Allgemeine Zeitung*, June 20, 2012.
-
- “Zukunft ist menschlich”; article quoting Etienne Benson and Jürgen Renn on the workshop “Anthropozän” in Berlin; *Frankfurter Allgemeine Zeitung*, July 4, 2012.
-
- “Das ist ein triumphaler Moment”; Jürgen Renn and Christoph Lehner interviewed on the discovery of the Higgs boson; *Tagesspiegel*, July 5, 2012.
-
- “Albert Einstein, un gigante sulle spalle di molti nani”; review of the Italian edition of Jürgen Renn’s book “Auf den Schultern von Riesen und Zwergen: Albert Einsteins unvollendete Revolution”; *Corriere della Sera*, July 21, 2012.
-
- “Warum die Mönche Rechtecke malten”; report on the Working Group “The Learned Practices of Canonical Texts”; *Tagesspiegel*, July 25, 2012.
-
- “Auf Skepsis gestoßen”; article on Dieter Hoffmann’s research on the Austrian physicist Victor Hess; *Märkische Allgemeine Zeitung*, August 9, 2012.
-
- “Die Sehnsucht nach Außerirdischen”; article on the history of astronomy, with input from Pietro Daniel Omodeo; *Märkische Allgemeine Zeitung*, August 9, 2012.
-
- * “Isarello heißt der Verschwörer!”; review by Andreas Mayer on a new edition of Carlo Ginzburg’s “Threads and Traces: True, False, Fictive”; *Frankfurter Allgemeine Zeitung*, August 16, 2012.
-
- “Wo einzelne Bäume stehen und wo der Wald”; interview with Lorraine Daston; *Der Standard*, August 28, 2012.
-
- * “Die Kunst des Messens”; Dieter Hoffmann on the history of the Physikalisch-Technische Reichsanstalt; *Tagesspiegel*, October 15, 2012.
-
- “Nah wohnt der Dichter am Irrsinn, und in der Anstalt ist das Rettende weit”; review of Yvonne Wübben’s book „Verrückte Sprache: Psychiater und Dichter in der Anstalt des 19. Jahrhunderts“; *Frankfurter Allgemeine Zeitung*, October 30, 2012.
-

“Wir sind Trendsetter”; interview with Urs Schoepflin on the digitization of historic documents; *Der Freitag*, December 14, 2012.

Magazines

“Der Forscher, der auf Bienen flog”; report on Tania Munz and her research project on Karl von Frisch; *MaxPlanckResearch*, 1/2010.

* “3D auf dem Vormarsch”; Jörg Kantel and Peter Damerow on the use of 3-D software in the humanities; *Max Planck Journal*, 1/2010.

“Lost Curve Hits a Nerve”; review of Henning Schmidgen’s book “Die Helmholtz-Kurven: Auf der Spur der verlorenen Zeit”; *Nature* 464, April 1, 2010.

“Gründerväter der Verhaltensforschung”; interview with Tania Munz about Nobel laureate Karl von Frisch; *Universum*, April 2010.

“Chalk to cheese”; review of Lorraine Daston’s book “Histories of Scientific Observation”; *Times Literary Supplement*, December 16, 2011.

“Geht es wirklich nur ums Geld?”; interview with Lorraine Daston on attracting top-level researchers to Germany; *Humboldt Kosmos*, December 2011.

“The Observer”; portrait of Lorraine Daston; *MaxPlanckResearch*, May 2012.

* “Biology – A Systemic Redefinition”; Hans-Jörg Rheinberger on “systems biology” and “synthetic biology”; *MaxPlanckResearch*, May 2012.

“The Science of the Studio”; article on the Max Planck Research Group “Art and Knowledge in Pre-modern Europe,” directed by Sven Dupré; *MaxPlanckResearch*, July 2012.

“Das Wesen der Forschung besteht im Übersteigen von Grenzen”; interview with Hans-Jörg Rheinberger on the sciences and their boundaries; *Gegenworte* 27, July 2012.

“Was bedeutet die Entdeckung der Higgs-Teilchen?”; interview with Jürgen Renn and Christoph Lehner on the discovery of the Higgs boson; *Cicero*, July 5, 2012.

“Alle Wissenschaften haben einen gemeinsamen Ursprung”; interview with Jürgen Renn; *Technology Review*, July 13, 2012.

“Vom Abschied des Idealhörers”; article on the conference “The Art of Listening: Trends and Perspectives of a History of Music Listening”; *neue musikzeitung online*, July 26, 2012.

“Auf Seitenpfaden zur Erkenntnis”; interview with Hans-Jörg Rheinberger on experiments; magazin. *Die Zeitschrift der Universität Zürich* 21/3, September 2012.

Radio

“Pillen für den Geist?”; interview with Nicolas Langlitz on cognitive enhancement; *SWR2 Impuls*, January 13, 2010

“Wissenswert”; portrait of Lorraine Daston; *RBB Inforadio*, February 3, 2010.

“Wissenswert”; portrait of Veronika Lipphardt; *RBB Inforadio*, November 3, 2010.

“Adolf von Harnack”; report on Dahlem, including an interview with Jürgen Renn; *RBB Inforadio*, November 25, 2010.

“Talking Brains”; report on the conference “Talking Brains,” with input from Fernando Vidal; *Deutschlandfunk*, December 9, 2010.

“Entziffert, entschlüsselt und entmachtet”; Hans-Jörg Rheinberger on research on the human genome; *Deutschlandfunk*, February 15, 2011.

“Querdenker – Unbequeme Revolutionäre in der Wissenschaft”; interview with Jürgen Renn; *WDR3*, May 23, 2011.

“Der Poet der Physik”; interview with Don Salisbury about John Archibald Wheeler; *Deutschlandfunk*, July 9, 2011.

“Fernrohre und konzentrierte Beobachtung”; interview with Lorraine Daston on the history of scientific observation; *Deutschlandfunk*, July 14, 2011.

“Von Wissensjägern und -sammlern”; interview with Lorraine Daston; *DRadio Wissen*, October 5, 2011.

“Schaffen Künstler Wissen?”; interview with Karin Leonhard; *RBB Kulturradio*, November 11, 2011.

“Von der Entdeckung der Ölfarbe bis zur Lehre von der Perspektive”; interview with Sven Dupré and Karin Leonhard; *Deutschlandfunk*, December 22, 2011.

“Genetik als Ingenieurwissenschaft”; interview with Hans-Jörg Rheinberger on synthetic biology; *SWR2 Wissen*, March 21, 2012.

“Eine Problematik steckt schon in seinem Leben”; interview with Dieter Hoffmann on Carl Friedrich von Weizsäcker; *DRadio Kultur*, June 28, 2012.

“Es ist ein großer Meilenstein, keine Frage!”; interview with Jürgen Renn on the discovery of the Higgs boson; *Deutschlandfunk*, July 6, 2012.

“The Art of Listening: Eine Potsdamer Tagung zum Musikhören”; interview with Hansjakob Ziemer; *DRadio Kultur*, July 12, 2012.

“Ein fundamentaler Fortschritt der Teilchenphysik”; radio feature on the history of astrophysics, including an interview with Dieter Hoffmann; *Deutschlandfunk*, August 7, 2012.

“Die Suche nach der Weltformel”; radio feature on research on elementary particles, including an interview with Jürgen Renn; *DRadio Kultur*, October 4, 2012.

“Die Kindheit des Kosmos”; radio feature including interviews with Jürgen Renn and Matthias Schemmel; *DRadio Kultur*, November 1, 2012.

“Beginning of the Nuclear Age”; interview with Horst Kant; *Deutschlandfunk*, December 2, 2012.

Television

“Wissenschaft im Social Network”; Jürgen Renn on the possibilities of scientific networks; *Deutsche Welle*, July 14, 2011.

“Digitale Revolution im Buchhandel”; interview with Jürgen Renn on digital publishing; *arte Metropolis*, March 17, 2012.

“Im Gespräch”; interview with Matteo Valleriani on the Celtic lunar calendar; *Deutsche Welle*, June 10, 2012.

“Research Topics” Online and In Print

In 2008, the MPIWG initiated a new format, “Research Topics,” for ongoing research activities at the MPIWG. Every six to eight weeks, research fellows present individual contributions of one relevant aspect of their research, or contributions pertaining to central aspects of the institute’s research agenda. “Research Topics” appears on the home page of the institute’s website and in a printed version available in the MPIWG’s entrance hall (circulation of 1,000 copies between 2010 and 2012, in both English and German). The online version makes the latest research easily available and offers links to sources, databases, audiovisual material, publications, authors, and partner institutions. The research topics are published regularly in German and English; in addition, authors are encouraged to publish in their native language, and individual research topics are available in French, Dutch, Chinese, Italian, and Catalan. Taken together, the collection of research topics gives a representative picture of the ways in which research is conducted at the institute. They will be presented in brochure form in 2013. The full archive is available online at www.mpiwg-berlin.mpg.de.

Research Topics 2010–2012



No. 11 Jean Piaget and the Child’s Spontaneous Geometry: A Study of Children’s Drawings as Psychological Instruments
(by Barbara Wittmann)



No. 12 The Concepts of Immanuel Kant’s Natural Philosophy: A Database Rendering Their Explicit and Implicit Networks
(by Wolfgang Lefèvre)



No. 13 Courting the Crafts in Qing China: Technology Diffusion and Communication through Media in Seventeenth-Century China
(by Dagmar Schäfer)



No. 14 “Every move will be recorded”: A Machinic Police Utopia in the Eighteenth Century
(by Grégoire Chamayou)



No. 15 The Uncertain Boundaries Between Light and Matter: A Long-Term History of Optical Dispersion, from Classical to Quantum Physics (by Marta Jordi Taltavull)



No. 16 Johann Lambert's Conversion to a Geometry of Space: Steps Towards a New Concept of Geometry in the 18th Century (by Vincenzo De Risi)



No. 17 Historical Epistemology: An Essay (by Hans-Jörg Rheinberger)



No. 18 Histories of Scientific Observation (by Lorraine Daston)



No. 19 "Let him reconquer language": The Construction of Deafness in Europe and the United States, 1600–1900 (by Sabine Arnaud)



No. 20 Baby Science in Fin-de-Siècle America (by Christine von Oertzen)



No. 21 Knowledgescapes: Geographical Information Systems and the History of Science (by Dagmar Schäfer and Falk-Juri Knauft)



No. 22 Art and Knowledge in Pre-modern Europe (by Sven Dupré)

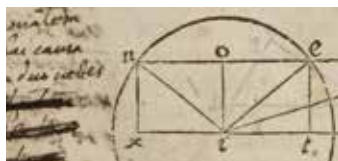

No. 23 The Equilibrium Controversy: A Case Study of the Long-Term Development of Mechanical Knowledge (by Jürgen Renn)



No. 24 Endangerment and Its Consequences:
Documenting and Preserving Nature and Culture
(by Fernando Vidal)

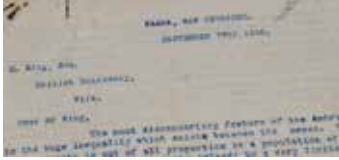

No. 25 Apprehending Human Difference and Population Size: Imbalanced Sex-Ratios, Human Variation, and the Colonial Regulation of Reproduction (by Alexandra Widmer)



No. 26 Parts Unknown: Making the Familiar Strange; Artist-in-Residence at the MPIWG
Explores the Interface Between Drawing and Astronomy (by Rohini Devasher)



No. 27 The Globalization of Knowledge and Its Consequences (by Jürgen Renn and Helge Wendt)



No. 28 Science Under Scrutiny: How Endangered Species Protection Reshaped Twentieth-Century Field Biology
(by Etienne Benson)

Overviews

Researchers and Guests

Oscar Joao Abdounur, Ph. D., Professor Associado, Universidade de São Paulo (Visiting Scholar, December 12, 2009–February 14, 2010, January 4–February 27, 2011, December 14, 2011–February 29, 2012, December 8, 2012–February 24, 2013)

Vanessa Agnew, Ph. D., Associate Professor for German Studies, University of Michigan (Visiting Scholar, December 1, 2012–February 28, 2013): Overland to Lobito Bay: The 1925 Scientific Expedition of Dorothea Bleek and Mary Pocock

Paula Tatla Amad, Ph. D., Associate Professor, Cinema and Comparative Literature, University of Iowa (Visiting Scholar, September 1–December 31, 2011): Tears in Time: The Archival Imaginary of Post-War French Cinema

Warwick Hugh Anderson, MD, PhD, Research Professor, Department of History, University of Sydney, Australia (Visiting Scholar, June 4–June 29, 2012): The sciences of race-mixing in the twentieth century

Daniel Andersson, Ph. D. (Postdoctoral Research Fellow, September 1, 2007–August 31, 2010): Styles of Observation and Experience in Renaissance Aristotelianism

Elisa Andretta, Ph. D. (Postdoctoral Research Fellow, September 1, 2010–June 30, 2011): Bringing Nature into the Court: The Vatican and the Reales Sitios as Places of Science (1555–1605)

Noam Andrews, Harvard University, USA (Predoctoral Research Fellow, August 1–31, 2011 and September 1–November 30, 2012): Microcosm/Macrocosm: Geometrical Thinking and Material Culture in Early Modern Europe

Theodore Arabatzis, Ph. D., Associate Professor of History and Philosophy of the Physical Sciences, University of Athens, Greece (Visiting Scholar, June 9–July 4, 2010): Hidden Entities and their Experimental Manifestations

Sabine Arnaud, Ph.D. (Research Group Director, November 1, 2010–January 31, 2016): The Construction of Deaf-Muteness and the Writing of Norms in Western Europe and the United States (17th to 19th Centuries)

Elena Aronova, Ph.D. (Research Scholar, September 1, 2012–August 31, 2015): Big Science in the Archive: Managing Big Data in America and the Soviet Union during the Cold War

Vesa Arponen, Sciences Studies Unit, University of Edinburgh (Predoctoral Research Fellow, January 1–March 31, 2010, funded by the Economic and Social Research Council): Society, Culture, and Environmental Problems

Monica Aufrecht, University of Washington, Seattle (Predoctoral Research Fellow, March 1–July 31, 2010): The History of the Distinction between the Context of Discovery and the Context of Justification

Angela Axworthy, Ph. D. (Postdoctoral Research Fellow, September 1, 2012–May 31, 2014, funded by the Fernand-Braudel funding program): The Ontological Status of Geometrical Objects in the Commentary on the Elements of Euclid of Jacques Peletier du Mans (1517–1582)

Safia Azzouni, Dr., (Visiting Scholar/Research Scholar, December 1, 2009–January 31, 2011, funded by the Deutsche Forschungsgemeinschaft): The Authority, Methods and Functions of Popular Science in the System of Sciences: Wilhelm Bölsche and Sexology

Nadja Sera Baadj, (Postdoctoral Research Fellow, August 20–September 30, 2012)

Guido Bacciagaluppi, Ph. D., Senior Lecturer, Department of Philosophy, University of Aberdeen, United Kingdom (Visiting Scholar, July 1–July 31, 2011, June 20–July 20, 2012): The Einstein Paradox

Nikolaus Bacht, Dr. (Emmy Noether Research Group Director, October 1, 2008–September 30, 2011, funded by the DFG): Philosophy and History of Listening

Massimiliano Badino, Ph. D. (Visiting Scholar, June 1, 2005–September 30, 2012, funded by the Fritz-Haber-Institut der Max-Planck-Gesellschaft): Thermodynamics and Statistical Mechanics from Boltzmann to Planck

Tawrin Baker, Indiana University, Bloomington, USA (Predoctoral Research Fellow, January 24–May 31, 2012): Color, Vision, and the Eye in Late Sixteenth-Century Padua

Jenny Bangham, Ph. D. (Postdoctoral Research Fellow, October 1, 2012–September 30, 2013): Blood Groups between Human Genetics, Anthropology and Transfusion Medicine in Mid-twentieth Century Britain

Angelo Baracca, Dr., Professor, Physics Department, University of Florence, Italy
(Visiting Scholar, August 8–September 14, 2012 and December 9–22, 2012):
History of Physics in Cuba

Stefan Bargheer, Ph. D. (Postdoctoral Research Fellow, January 1–March 31, 2010
and September 1, 2010–July 31, 2012): Biological Diversity and Cultural Pluralism:
The Changing Valuation of Complexity in Nature and Culture

Elisabetta Basso, Ph. D. (Postdoctoral Research Fellow, March 1–May 31, 2010):
Phenomenology and Psychiatry: An Epistemological History of the Concept of
“Structure”

Manuela Bauche, Universität Leipzig (Predoctoral Research Fellow, January 1–
March 31, 2010)

Susanne Bauer, Dr. (Research Scholar, September 1, 2009–December 31, 2011):
Micropolitics of Difference: Soviet/Russian Biomedical Sciences from the Atomic
Age to Post-Genomics

Antonio Becchi, Dr.-Ing. (Research Scholar/Visiting Scholar, October 8, 2008–
December 31, 2016): Epistemic History of Architecture

Naomi Beck, Ph. D., (Postdoctoral Research Fellow, December 1, 2012–August 31,
2013): Cultural Evolution and the Free Market: Hayek’s Theory of Group Selection

Jenny Beckman, Ph. D., Research fellow, Stockholm Resilience Centre, Stockholm
University (Visiting Scholar, February 15–May 15, 2010): Linnaeus among the
amateurs: History, systematics, and biodiversity recording in Sweden 1970–2010

Bruno Belhoste, Ph. D., Professor of History of Science, University Paris 1 Panthéon
Sorbonne, Paris, France (Visiting Scholar, August 1–August 31, 2012): Science in
metropolis: Paris and its savants in early 19th century

Delphine Bellis, Ph. D. (Postdoctoral Research Fellow, July 1–August 31, 2011): The
Emergence of a Natural Geometry of Vision from Ptolemy to Kepler and Descartes

Etienne Benson, Ph. D. (Research Scholar, September 1, 2010–August 31, 2013):
Ethics, Epistemology, and Law in Endangered Species Research

Sven Bergmann, (Predoctoral Research Fellow, September 1–December 31, 2011)

Joshua Berson, Ph. D. (Postdoctoral Research Fellow, September 1, 2010–
September 30, 2012): Archiving Indigeneity: Language Documentation and the
Pragmatics of Decolonization

Domenico Bertoloni Meli, Ph. D., Professor of History and Philosophy of Science, Indiana University, Bloomington (Visiting Scholar, June 1–June 29, 2010): Observing Life Processes: Vivisection from Colombo to Haller

Paola Bertucci, Ph. D., Assistant Professor, History of Science, History of Medicine Program, Department of History, Yale University, New Haven, USA (Visiting Scholar, June 1–June 30, 2012): Perfecting the arts in eighteenth-century Paris: Craft knowledge and the sciences at the Société des Arts

Jean-Marc Besse, Ph. D., Director of Research, Centre National de la Recherche Scientifique (CNRS) (Visiting Scholar, March 1–May 31, 2012): Antoine Lafreri's Atlases: Collecting, Conserving and Representing Geographical Knowledge

Berit Bethke, DFG-Graduiertenkolleg "Weltgesellschaft", Universität Bielefeld (Predoctoral Research Fellow, November 1, 2010–February 28, 2011): Global Knowledge and Local Views

Peter Beurton, Dr. (Research Scholar, September 1, 1994–March 31, 2006, associated): Research Strategies in Biological Evolutionary Theory; Modern Darwinism and the Philosophy of Science

Johanna Biank (Predoctoral Research Fellow, December 1, 2012–December 1 2016, funded by the Collaborative Research Center 980 'Episteme in Motion'): Transfer of Knowledge from the Ancient World to the Early Modern Period

Charlotte Bigg, Ph. D., Centre Alexandre Koyré/CNRS, Paris, France (Visiting Scholar, February 1–June 30, 2012, funded by the CNRS): Photography and Astronomy

Sarah Blacker, University of Alberta, Canada (Predoctoral Research Fellow, March 1–May 31, 2012): The Pharmacogenomic and Epidemiological Concepts of Human Genetic Variation in the Development of Personalized Medicine.

Estelle Blaschke, E.H.E.S.S. / Université Paris I - Sorbonne (Predoctoral Research Fellow, November 1, 2009–July 31, 2011): The Excess of the Photographic Archive

Henny Blomme, (Postdoctoral Research Fellow/Visiting Scholar, April 1–July 15, 2012): Space As Some Kind of Nothing

Alexander Blum, Dr. rer. nat. (Postdoctoral Research Fellow/Research Scholar, May 1, 2010–October 31, 2014): Geschichte der Quantenfeldtheorie und der Quantengravitation

Marjolijn Bol, Ph. D. (Postdoctoral Research Fellow, August 1–October 31, 2012): Crafting Splendor and Examining Light The artisan's contribution to the study of optics, 1100–1700

William G. Boltz, (Visiting Scholar, August 1–August 31, 2007)

Stefan Borchers, Dr. des. (Postdoctoral Research Fellow, March 1, 2009–February 28, 2011): Propagation of the Soul — Inheritance of Sin

Francesca Bordogna, Ph.D., Associate Professor, Northwestern University (Visiting Scholar, October 1, 2009–June 30, 2010): The Pragmatist Hotel: Psychology as a Way of Life

Stefano Bordoni, Ph.D. (Visiting Scholar, August 5–September 9, 2012): Pierre Duhem’s “third pathway” to Thermodynamics

Arianna Borrelli, Dr. (Visiting Scholar, September 1, 2005–January 31, 2010, funded by the Fritz-Haber-Institut der Max-Planck-Gesellschaft): The Role of Molecules in the Development of Quantum Mechanics, with a Special Regard for the Contribution of Michael Polanyi and Eugene Wigner

Mineke Bosch, Dr., Professor of Modern History, University of Groningen (Visiting Scholar, October 15, 2010–February 15, 2011): Assets and Liabilities of Women Scientists’ Networks: The Case of Johanna Westerdijk

Marie-Pier Boucher, Duke University, Durham, USA (Predoctoral Research Fellow, June 1–July 31, 2010): Infra-Psychic Individuation: Transductive Connections and the Genesis of Living Techniques

Dan Bouk, Ph.D., Assistant Professor of History, Colgate University, Hamilton, USA (Postdoctoral Research Fellow, September 1, 2012–August 31, 2013): How our Days Became Numbered: The Development of a Statistical Infrastructure of Risk in the United States, 1873–1935

Katherine Sara Boyce-Jacino, Johns Hopkins University, Baltimore, USA (Predoctoral Research Fellow, June 1–June 30, 2011): The Modern History of Astronomy

Katharina Brandenberger, Universität Zürich (Predoctoral Research Fellow, November 1, 2009–April 30, 2010, funded by the Schweizerischer Nationalfonds): Psychotropic Drugs in Clinics and Society, 1950–1970

Christina Brandt, Dr. (Research Scholar, June 1, 2003–January 31, 2011, funded by the Minerva Program of the Max Planck Society): Reproduction in Biology. Configurations between Science and Culture, 1900–2000

Francesca Bray, Ph.D., Professor of Social Anthropology, University of Edinburgh (Visiting Scholar, January 15–May 15, 2010): Significant technologies: rethinking technology as a heuristic in Chinese history

Andrea Bréard, Maître de conférences, Université des Sciences et Technologies, Lille, France & Professeur Chargé de Cours, Département Humanités Sciences Sociales, Ecole Polytechnique, France (Visiting Scholar, July 15, 2010–July 14, 2011): Mediating Tradition and Innovation: Translating Statistics into Late Imperial China

Sonja Brentjes, Dr. (Research Scholar, since April 15, 2012): Edition of Arabic texts on Mechanics

S. Pearl Brilmyer, The University of Texas at Austin (Predoctoral Research Fellow, September 1, 2011–June 30, 2012): Character Drives: Vitality and the Victorian Novel

Mirjam Brusius, Ph. D. (Postdoctoral Research Fellow, September 1, 2012–August 31, 2013): The Canon Under Threat: Processes of (De)canonization of Middle Eastern Archaeological Finds

Jed Zachary Buchwald, Ph. D., Professor for the History of Science (Visiting Scholar, September 1–October 11, 2011): Champollion, Young and the Decipherment of Hieroglyphs

Jochen Büttner, Dipl. Phys., Dr. des. (Research Scholar, July 1, 2004–October 31, 2012, Topoi Reserch Group Director November 1, 2012–October 31, 2017): Early Modern Mechanics, Innovation in the Ancient World

Andrey Bukhman, (Research Scholar, January 11, 2010–June 30, 2012): Max Planck Digital Library

Guy Burak, New York University (Predoctoral Research Fellow, July 1–August 31, 2012): Reliable Books: Islamic Law, Canonization and Manuscripts in the Ottoman Empire (16th–18th Centuries)

Felicity Callard, Ph. D. (Postdoctoral Research Fellow, March 1, 2011–February 29, 2012 and July 1–September 15, 2012): The Adolescent Daydreamer

Celine Camps, University of Utrecht (Predoctoral Research Fellow, October 1, 2012–March 1, 2013)

Jane Caplan, DPhil, Professor of Modern European History, University of Oxford (Visiting Scholar, January 1–April 30, 2011): Policing and Proving Identity in Nazi Germany, 1933–45

Martin Carrier, Dr. Professor für Philosophie, Universität Bielefeld (Visiting Scholar, October 1, 2010–January 31, 2011): Commercialization and Politicization of Science

John Carson, Ph. D., Associate Professor for History at the University of Michigan, USA (Visiting Scholar, September 15–December 31, 2010, March 1–April 30, 2011, and June 1–August 31, 2012, funded by the University of Michigan): *Between Law and Science: Unsoundness of Mind in Anglo-American Medical Jurisprudence*

Giuseppe Castagnetti, (Research Scholar, since April 1, 2003): *History of Institutions of Physics in the 20th Century; Political and Social Context of Albert Einstein's Activities in Berlin.*

Robert Casties, Dr. (Research Scholar, since January 1, 2002): *Information Technology Group*

Francesco Paolo de Ceglia, Ph. D., University of Bari (Visiting Scholar, September 1–December 31, 2012): *Practices and Paths of Rationality in 18th Century Naples*

Adriana Cesar De Mattos, Ph.D. (Visiting Scholar, December 12, 2009–February 11, 2010)

Grégoire Chamayou, Ph. D. (Research Scholar, September 1, 2009–October 31, 2010): *The History and Philosophy of “Traceability”*

Karine Chemla, Ph. D., Professor and Director of Research, Université Paris 7, France (Visiting Scholar, August 1–August 31, 2012): *How to Describe Scholarly Cultures?*

Tobias Cheung, PD Dr. (Visiting Scholar, May 1, 2012–June 30, 2013, funded by the Deutsche Forschungsgemeinschaft — Heisenberg Programm): *Agent Models: Constellations between Biology, Anthropology Psychology and Philosophy 1800-2000*

Suparna Choudhury, Ph. D. (Research Scholar, September 1, 2008–August 31, 2012, funded by the Minerva Program of the Max Planck Society): *Constructions of the Brain: Critical Neuroscience and the Adolescent Brain*

John Christie, Ph. D., History Faculty University of Oxford, Senior Research Fellow & Research Supervisor, History & Philosophy of Science, University of Leeds. (Visiting Scholar, January 1–June 30, 2010): *The Observational Regimes of pre-Lavoisian Chemistry in the 18th Century*

Mark Clarke, Ph. D. (Postdoctoral Research Fellow, February 1–February 28, 2012): *The Co-Transmission of Mediaeval Paint Recipes as an Indicator of the Inter-Penetration of Colour Theory, Artists' Practical Knowledge and Domestic Science*

Samuël Coghe, European University Institute in Florence, Italy (Predoctoral Research Fellow, March 1–August 31, 2011): *Population Politics in the Tropics. Knowledge and Colonial Rule in Portuguese Angola, 1900–1940*

Daide Crippa, Université Paris VII — Denis Diderot, France (Predoctoral Research Fellow, July 1–September 30, 2012): Revisiting the Distinction between Geometrical and Mechanical Curves in Early Modern Geometry

Elise Crull, (Visiting Scholar, July 3–August 4, 2012): The Einstein Paradox: the Debate on Incompleteness and Nonlocality in 1935

Alex Csiszar, Ph. D., Assistant Professor, History of Science, Harvard University (Postdoctoral Research Fellow, February 1–June 30, 2012): Print Seriality and Epistemologies of Search during the Nineteenth Century

Lianbin Dai, Ph. D. (Postdoctoral Research Fellow, July 1–August 31, 2012): From Philology to Philosophy: Zhu Xi as a Reader-Annotator

Peter Damerow, PD Dr. (Research Scholar, January 1, 1997–December 31, 2005, associated 2006–2011): History of Science and Education, Individual and Historical Development of Cognition, Genesis of Writing and Arithmetic, History of Mathematics and Physics in Ancient and Early Modern Period.

Lorraine Daston, Ph. D., Professor, Committee on Social Thought, University of Chicago (Executive Director, since July 15, 1995): Moral and Natural Orders, History of Scientific Data, Cognitive Practices of Science

Sophia Danielle Davis, Ph. D. (Postdoctoral Research Fellow, November 1, 2010–August 31, 2011): Mining the Sky: British Bird Observatories and Radar Ornithology, 1935–1965

Vincenzo De Risi, Ph. D. (Research Group Director, October 1, 2010–December 31, 2015): Modern Geometry and the Concept of Space

Didier Debaise, Ph. D. (Postdoctoral Research Fellow, October 1, 2008–September 30, 2010, funded by the Alexander-von-Humboldt-Stiftung): The Emergence of an Evolutionary Philosophy

Valérie Debuiche, Ph. D., enseignante agrégé de Philosophie, Lycée Robert de Luzarches, Amiens, France (Postdoctoral Research Fellow, July 1–August 31, 2011): Leibniz et l'invention du Calculus Situs: l'influence de Desargues et de Pascal

Tamás Demeter, Ph. D. (Lorenz Krüger Postdoctoral Research Fellow, June 1, 2008–October 31, 2010): Hume and the Ideology of the Scientific Revolution

Rohini Devasher, New Dehli (Artist in Residence, March 1–June 30, 2012): The Light of Things Hoped for

Nélia Dias, Ph. D., Associate Professor, Department of Anthropology, ISCTE/IUL, Lisbon, Portugal (Visiting Scholar, October 1–November 15, 2010 and July 10–August 10, 2012): Circulation in Nineteenth-Century France: Blood, Water, and Railroads

Sven Dupré, Dr., Professor of History of Knowledge, Institute for Art History, Freie Universität Berlin (Research Group Director, July 1, 2011–September 30, 2016)

Thomas Ebke, M. A. Universität Potsdam (Predoctoral Research Fellow, July 1–December 31, 2010): Vital Knowledge of Life in Georges Canguilhem’s Historical Epistemology and Helmuth Plessner’s Philosophical Anthropology

Sophia Efstathiou, Ph. D. (Postdoctoral Research Fellow, July 20–August 19, 2010): Found Science: Using Race Concepts in Science

Michael Elazar, (Postdoctoral Research Fellow, September 1, 2009–June 30, 2011): Jesuit Science in the 17th Century

Yehuda Elkana, Professor, President and Director Emer. of the Central European University, Budapest, Hungary (Visiting Scholar, August 1, 2010–September 2012): The University of the 21st Century: An Aspect of the Globalized World

Raluca Enescu, Ph. D. (Postdoctoral Research Fellow, November 1, 2012–August 31, 2013): The Legal Capacity of the Deaf in the Decisions of the Imperial Court of Justice

Olaf Engler, Dr., Center for Logic, History and Philosophy of Science, University of Rostock (Research Scholar/ Visiting Scholar, since October 1, 2006): Concepts, Methods, and Implementations of Historical Epistemology; History and Philosophy of Science in the 18th and 19th Century

Eric Engstrom, Ph. D., Research Associate, Department of History, Humboldt-Universität zu Berlin (Visiting Scholar, November 1, 2009–January 31, 2010): Emil Kraepelin’s Research on Native and African American Psychiatric Patients and his Trip to the United States in 1925

Paul Erickson, Ph. D., Assistant Professor, Wesleyan University, Middletown, USA (Visiting Scholar, June 15–July 31, 2010 and January 1–April 30, 2012): Strangelovean Science: Mathematical Theories of Rational Choice Since WWII

Kasper Risbjerg Eskildsen, Ph. D., Associate Professor at the Department of Philosophy and Science Studies, University of Roskilde, Denmark (Visiting Scholar, February 1–July 31, 2011): Disciplinarity and the Division of the Human Past

David Daniel Estévez Durey, Fundación Canaria Orotava de Historia de la Ciencia (Visiting Scholar, September 1–October 31, 2011, September 1–October 31, 2012): Digital Humanities

Guillermo de Eugenio Pérez, Ph. D. (Postdoctoral Research Fellow, February 1–May 7, 2012): The Physician and the Passions: Techniques of the Self in 18th Century English and French Medical Treatises

Nike Verena Fakiner, Spanish Research Council, Institute for Philosophy, Madrid (Predoctoral Research Fellow, January 15–April 15, 2012): Material Properties and Subjective Experiences: Gustav Zeiller’s Anatomical Wax Models

Marie Farge, Ph. D., Professor for Mathematics and Research Director CNRS, Paris, France (Visiting Scholar, May 1–May 31, 2012): D’Alembert and the Problem of Deduction from New Principles

Aude Fauvel, Ph. D. (Postdoctoral Research Fellow, September 1, 2009–December 31, 2010): ‘The Weaker Mind’. Female Patients and the Shaping of Psychiatry. 19th–20th c.

Andrew M. Fearnley, Cambridge University (Predoctoral Research Fellow, September 1, 2009–June 30, 2010): Methods to Madness: Race, Knowledge and American Psychiatry, 1880–2000

Rivka Feldhay, Ph. D, Associate Professor at the Cohn Institute for the History and Philosophy of Science and Ideas at Tel Aviv University (Visiting Scholar, June 18–August 25, 2010, July 1–August 31, 2011, and August 12–September 8, 2012)

Isabella Ferron, Ph. D. (Visiting Scholar, January 6–February 17, 2012): Wilhelm von Humboldt and the Human Diversity

Hans Dietrich Fick, Dr., Prof. of Physics at the Philipps-Universität Marburg (Visiting Scholar, February 15–September 30, 2012): History and Foundation of Quantum Mechanics

Maja Fjaestad, Royal Institute of Technology, Sweden (Predoctoral Research Fellow, September 12, 2008–July 31, 2010, funded by the Bank of Sweden, Tercentenary Foundation): Nuclear Power History. Utopian Aspects of the Swedish Nuclear Breeder Program.

Martha Fleming, Ph. D., Curator (Curator in Residence, March 1–March 31, 2012): Natural History Museums as Scientific Repositories and Research Laboratories

Fabio Freitas, Universidad Estadual de Feira de Santana, Brazil (Predoctoral Research Fellow, December 1, 2009–February 28, 2010): The Emergence of Decoherence: The Many Ways of a Physical Phenomenon

Gideon Freudenthal, Dr., Professor of Philosophy at the Tel Aviv University (Visiting Scholar, May 1–October 31, 2010, September 1–September 30, 2011)

Judith Friedman, Ph. D. (Postdoctoral Research Fellow, May 1–August 31, 2010):
An Analysis of Locational and Professional Diversity in the Study of Anticipation in Hereditary Disease in Western Europe 1900–1950

Michael Friedman, Ph. D., Frederick P. Rehmus Family Professor of Humanities (Visiting Scholar, October 1–November 30, 2010, March 1–August 31, 2011): The Dynamics of Reason: An Essentially Historical Response to the Challenge to the Rationality and Objectivity of Science Arising in the Wake of Thomas Kuhn’s Theory of Scientific Revolutions

Markus Friedrich, PD Dr., Universität Frankfurt /M (Visiting Scholar, March 1–August 31, 2012): Archival Culture in Early Modern Europe: New approaches to an old topic

Yulia Frumer, Ph. D. (Postdoctoral Research Fellow, September 1, 2012–August 31, 2013): A Matter of Time: Changing Clock Habits in Edo Japan

Courtney Fullilove, Ph. D., Assistant Professor of History, Wesleyan University (Visiting Scholar, September 1–December 31, 2012): Turkey Red Wheat: the American Breadbasket and the Organization of Global Plant Genetic Resources

Isabel Gabel, Columbia University (Predoctoral Research Fellow, September 1–December 31, 2011 and May 1–June 30, 2012): Epistemologies of the Living and the Emergence of Biopolitical Thinking

Stefanie Gänger, Darwin College, Cambridge, United Kingdom (Predoctoral Research Fellow, July 1–September 30, 2010): The Land of the Incas. Antiquarianism and the Inca past in Cuzco, 1840s–1900s

Tuvdendorj Galbaatar, Ph. D., Professor (Visiting Scholar, October 21–November 20, 2010)

Juan Manuel Garrido, Ph. D. Associate Professor and Director of the Humanities Institute, Universidad Diego Portales, Santiago de Chile, Chile (Visiting Scholar, October 1–October 20, 2012): Kant, Experimental Life Sciences, and the Knowledge of Life

Rodolphe Gasché, Ph. D., Distinguished Professor & Eugenio Donato Chair of Comparative Literature, University at Buffalo, The State University of New York (Visiting Scholar, June 1–July 15, 2011, June 1–July 1, 2012)

Maurizio Gatto, Ph. D. (Visiting Scholar, January 1, 2010–December 31, 2011): The lexicon of the Aristotelian „Mechanical Problems“

Nicolás Gaudenzi, Universidad Nacional Autónoma de México (UNAM) (Master Student, January 1–May 31, 2012)

Bernd Gausemeier, Dr. (Research Scholar, October 1, 2004–February 28, 2014): History of the Biomedical Institutes in Berlin–Buch

Ido Geiger, Ph. D. (Postdoctoral Research Fellow, October 1, 2009–September 30, 2010, funded by the Minerva Foundation)

Alexa Geisthövel, Ph. D. (Visiting Scholar, April 1–June 30, 2012): Intelligenz und Rasse. Franz Boas' psychologischer Antirassismus zwischen Amerika und Deutschland, 1910–1940

Donatella Germanese, Dr. (Research Scholar, since September 1, 2012): Science and Technology in Italian Literary Journals, 1945–1967

Pascal Germann, University of Zurich, Switzerland (Predoctoral Research Fellow, September 1–November 30, 2010 and October 1–December 31, 2012, funded by the Swiss National Science Foundation): Nature's laboratories. Racial Research and Human Genetics in Switzerland, 1920–1970

Stefanos Geroulanos, Ph. D., Assistant Professor of History, New York University (Visiting Scholar, September 1–December 31, 2011, funded by the New York University): Constructions of the “New Man” in European Thought and Culture

Anne Gerritsen, Ph. D., Associate Professor, University of Warwick, U.K. (Visiting Scholar, July 3–August 16, 2010): Shufu Wares and Imperial Control over Ceramic Technologies during the Yuan Dynasty

Polyxeni Giannakopoulou, National Technical University of Athens (Predoctoral Research Fellow, July 1–July 31, 2011): Popularization of Science by Women in Greece

Giulia Giannini, Ph. D. (Postdoctoral Research Fellow, October 1, 2012–April 30, 2015, partly funded by the Alexander-von-Humboldt-Stiftung): Lorenzo Magalotti and the Accademia del Cimento

Sebastián Gil-Riaño, Institute for the History of Science, Victoria College, Toronto, Kanada (Predoctoral Research Fellow, September 1–October 30, 2011): The Rise of Scientific Anti-Racism: a Historical Epistemology of UNESCO's Campaigns against Racism, 1945–1978

Günther Görz, Dr.-Ing., Prof. für Informatik, Universität Erlangen-Nürnberg, Deutschland (Visiting Scholar, since October 18, 2010): Semantic Modelling and Knowledge Representation for Scientific Object Documentation and Digital Editions

Johanna Gonçalves Martín, University of Cambridge (Predoctoral Research Fellow, July 1–September 30, 2012): Paths of health: gender and reproductive medicine articulations amongst Yanomami people and doctors in Venezuela

Michael Gordin, Ph. D., Associate Professor of History at Princeton University (Visiting Scholar, June 15–August 31, 2010): Cold War Rationality

Jean-Baptiste Gouyon, Ph. D. (Postdoctoral Research Fellow, September 1, 2009–August 31, 2010): Archiving the Doomed. Fashioning a Public Science of Conservation

Softya Grachova, Harvard University, USA (Predoctoral Research Fellow, August 15–December 15, 2011): The Politics of Jewish Life: Medicine and the Jewish Politics in the Russian Empire and the USSR, 1881–1930

Anthony Grafton, Ph. D., Professor of History, Princeton University, USA (Visiting Scholar, July 6–August 17, 2012): Learned Practices of Canonical Texts

Carmine Grimaldi, University of Chicago, USA (Predoctoral Research Fellow, April 1–June 30, 2012): Communicating Subjective Vision

Nils Güttler, Humboldt-Universität zu Berlin (Predoctoral Research Fellow, November 1, 2008–July 31, 2011, funded by the Studienstiftung des Deutschen Volkes): The Cosmoscope and Its Users: The Role of Maps in 19th-Century Plant Geography

Jacob K. Habinek, University of California, Berkeley (Predoctoral Research Fellow, September 1–December 31, 2011, funded by the DAAD and UC Berkeley): The Social Origins of Life Science Disciplines in Nineteenth-Century Germany

Jeanne M. Haffner, Ph. D. (Visiting Scholar, December 1–December 29, 2011): Maladaptation. Visual Taxonomies of Human Habitation and Social Scientific Critiques of the Grands Ensembles in 1960s France.

Orit Halpern, Ph. D., Assistant Professor, Committee on Historical Study at the New School for Social Research, New York (Visiting Scholar, January 1–March 31, 2011): Dreams for our Perceptual Present: Psychosis, Rationality, and Politics in Cold War American Social Science and Designe

Carmen Hammer, (Research Scholar, April 1, 2008–March 31, 2012): Scientific Supervision of Research Infrastructures Used within Projects: Development and Coordination of Archive Material

Marta Hanson, Ph. D., Assistant Professor, John Hopkins University, Dept. of the History of Medicine (Visiting Scholar, July 1–September 30, 2011): Understanding is within One's Grasp: Hand Mnemonics, Chinese Arts of Memory, and the Esoteric-vernacular Spectrum of Knowledge

Jonathan Harwood, Ph. D., Professor in the History of Science and Technology at the University of Manchester (Visiting Scholar, June 11–July 12 and November 11–December 15, 2010, November 18–December 18, 2012): *Europes Green Revolution: the Rise and Fall of Peasant-Friendly Plant-Breeding in Central Europe, 1890–1945*

Felix Hasler, Ph. D., Research Associate in Psychopharmacology, University of Zurich, Switzerland (Visiting Scholar, May 18, 2010–January 31, 2011): *Neuromythologie*

Juan HE, Ph. D., Institute for the History of Natural Science, Chinese Academy of Sciences, Beijing (Visiting Scholar, February 1–June 30, 2010)

Daniela Helbig, Harvard University (Predoctoral Research Fellow, August 1–August 31, 2010): *Turbulence in Flight and Fluid Dynamics between the World Wars*

Catherine Herfeld, Duke University (Predoctoral Research Fellow, October 1–November 30, 2011 and January 1–March 31, 2012): *Tracing the Origins of Normativity and Individual Choice in Cold War Economics*

Ina Heumann, IFK — International Research Center for Cultural Studies, Vienna (Predoctoral/Postdoctoral Research Fellow, February 1–December 31, 2010, October 1–December 31, 2011): *Styles of Science Communication. German-American Transfer Histories, 1945–1984*

Oliver Hochadel, (Postdoctoral Research Fellow, August 16–August 30, 2010)

Christoph Hoffmann, Dr., Professor für Wissenschaftsforschung, Universität Luzern (Visiting Scholar, June 15–July 31, 2010, funded by the Universität Luzern): *Epistemic Writings*

Dieter Hoffmann, Dr., Außerordentlicher Professor an der Humboldt Universität zu Berlin (Research Scholar, since December 1, 1995): *History of Physics in the 19th and 20th Centuries, esp. Institutional History of Quantum Theory and Modern Metrology; History of Science in the GDR.*

Anna Holterhoff, Humboldt-Universität zu Berlin (Predoctoral Research Fellow, June 1, 2009–May 31, 2013, funded by the Excellence Cluster Topoi): *The Establishment and Reconstruction of Copernicanism from the 16th to the 18th Century*

Giora Hon, Ph. D., Professor for Philosophy and History of Science at the University of Haifa (Visiting Scholar, August 1, 2010–February 15, 2011, July 1–September 30, 2011): *Annotated Edition of: Die Mechanik in ihrer Entwicklung historisch-kritisch dargestellt von Ernst Mach*

Thierry Hoquet, Dr., Maître de Conférences. Université Paris 10 (Visiting Scholar, April 15–May 15, July 17–August 17, 2010): Phylogeny and the Direction of Evolution

Florence Hsia, Ph. D., Associate Professor at the University of Wisconsin-Madison (Visiting Scholar, May 15–June 30, 2010 and January 1–April 30, 2012): Archival Reasoning: Astronomy, Chronology, History

Axel Caesar Huentelmann, Dr., Wissenschaftlicher Mitarbeiter an der Bielefeld Graduate School in History and Sociology (Universität Bielefeld) (Visiting Scholar, August 1–September 30, 2011): Biologische Ökonomien: Eine Geschichte des Wachstums (ca. 1770–1970)

Moritz Hütten, Universität Rostock (Predoctoral Research Fellow, September 15–March 31, 2012)

Pim Huijnen, Ph. D. (Postdoctoral Research Fellow, July 1–August 31, 2011): The Promise of Vitamins. The Collaboration between Universities, Industry and the Government in the Netherlands, 1918–1945

Brad Hume, Ph. D., Assistant Professor, Department of History, University of Dayton (Visiting Scholar, January 15–May 15, 2010): Studies in the Cultural History of Heredity

Ludmila Hyman, Ph.D. (Postdoctoral Research Fellow, September 1, 2007–August 31, 2011): The Role of Concepts in Scientific Reasoning

Scott Hyslop, Indiana University, Bloomington, USA (Predoctoral Research Fellow, February 1–May 31, 2011): Shared Knowledge

Sarah Igo, Ph. D., Associate Professor of History, Vanderbilt University (Visiting Scholar, June 4–July 4, 2012): Theorizing the Surveillance Society: Bodies of Data and ‘Data Bodies’ in the 1970s

Hajime Inaba, Kyoto University, Japan (Predoctoral Research Fellow, December 1, 2012–March 31, 2014, funded by DAAD): The origin of equilibrium statistical mechanics: Boltzmann, Planck and Einstein

Martin Jähnert, M. A. (Predoctoral Research Fellow, October 1, 2011–September 30, 2013): Practice of the Correspondence Principle in the Old Quantum Theory; Early Debates on the Interpretation of Quantum Mechanics

Josephine Jahn, Magister Artium Humangeographie/ Soziologie (University of Potsdam) (Predoctoral Research Fellow, August 1, 2012–July 31, 2014): Biomedical Research and Clinical Practice at the Biomedical Institutes in Berlin-Buch

Jeremiah James, Ph. D. (Visiting Scholar, September 1, 2008–September 30, 2013, partially funded by the Fritz-Haber-Institut der Max-Planck-Gesellschaft): Early History of Quantum Theory

Vladimir Jankovic, Ph. D., Lecturer, Centre for the History of Science, Technology and Medicine, University of Manchester, UK (Visiting Scholar, May 1–June 30, 2011): Grids: Modeling, Scalar Politics and the Selective Visibility of Weather

Andreas Janousch, Ph. D., Associate Professor (Professor Contratado Doctor) of Chinese History and Religion at the Universidad Autónoma de Madrid, Spain (Visiting Scholar, July 26–September 5, 2010, July 18–August 16, 2011): Technical Knowledge in a Religious Space: Salt Production and the Cult to the Salt Lake Deity in Southern Shanxi

Chihyung JEON, Ph. D. (Postdoctoral Research Fellow, September 1, 2010–August 31, 2011): Anthropometric Data Banks and the Making of the Dimensional Body

Leyla Mariane Joaquim, Federal University of Bahia, Institute of Physics. (Predoctoral Research Fellow, February 1–February 28, 2010, February 1–July 31, 2012, funded by the Brazilian Federal Agency for Support and Evaluation of Postgraduate Education — CAPES): Where Physics meets Biology: some historical and contemporary perspectives

Christian Joas, Dr. (Research Scholar, February 15, 2007–November 30, 2012, funded by the Fritz-Haber-Institut der Max-Planck-Gesellschaft): The genesis of wave mechanics: Erwin Schrödinger's research notebooks; The transfer of concepts between high-energy and condensed-matter physics and the advent of quantum field theoretical methods in solid-state physics

Marta Jordi Taltavull, BA in Physics and Master in Advanced Physics at the University of Barcelona (Predoctoral Research Fellow, February 1, 2009–December 31, 2012): History of Optical Dispersion, from Classical to Quantum Physics

Edward Jurkowitz, Ph. D. (Visiting Scholar, June 15, 2008–June 15, 2010, funded by the Fritz-Haber-Institut der Max-Planck-Gesellschaft): The role of computation in solid-state physics

Ann M. Kakaliouras, Ph. D., Associate Professor of Anthropology, Whittier College, Whittier, USA (Visiting Scholar, October 1–November 30, 2012): A Historical Ethnography of the Making of Anthropology's 'Indian'

Stephan Kammer, Dr. (Visiting Scholar, March 1, 2008–December 31, 2010, funded by the Deutsche Forschungsgemeinschaft): Strokes and Expressions: The History of Graphological Knowledge (1750–1950)

Horst Kant, Dr. (Research Scholar, October 1, 1995–March 31, 2011, associated): History of Physics in the 19th and 20th Centuries (esp. Atomic Physics and Institutional and Social Aspects).

Ryan Amir Kashanipour, Department of History, The University of Arizona, USA (Predoctoral Research Fellow, March 8–July 31, 2011): A World of Cores: Yocatec Healing in the Eighteenth Century Atlantic World

Robert Kaster, Ph. D., Kennedy Foundation Professor of Latin Language and Literature, Professor of Classics, Princeton University, USA (Visiting Scholar, July 6–August 17, 2012): Making Sense of Suetonius in the Twelfth Century

Iraklis Katsaloulis, University of Athens (Visiting Scholar, June 15–July 15, 2010)

Shaul Katzir, Ph. D. (Visiting Scholar, August 1, 2008–July 31, 2011, July 16–August 15, 2012, funded by the Alexander-von-Humboldt-Stiftung)

Theresa M. Kelley, Ph. D., Professor of English at the University of Wisconsin — Madison (Visiting Scholar, July 17–August 16, 2011): Color Theory, Color Systems and the Status of Color in Taxonomic Systems and Botanical Illustration

Hartmut Kern, M. A. (Research Scholar, since December 1, 2001): Project: Visualization and Publishing Scientific Content with Internet Technologies.

Lara Keuck, Dr. (Visiting Scholar, August 27–October 19, 2012): Of Human Families and Mutant Mice Strains: Transfer and Transformation of Knowledge about Alzheimer's Disease in the early 1990s

Stefanie Klamm, Humboldt-Universität zu Berlin (Predoctoral Research Fellow, October 1, 2010–March 31, 2011, funded by the Excellence Cluster Topoi): Images of the Past: Strategies of Archaeological Visualisation in the 19th Century

Joel Klein, Dept. of History and Philosophy of Science, Indiana University, Bloomington, USA (Predoctoral Research Fellow, September 1, 2011–June 30, 2012, funded by the DAAD): Bringing Chymistry into Shape: The Ideas, Intellectual Context, and Influence of Daniel Sennert (1572–1637)

Judy Klein, Professor of Economics, Associate Director of Institutional Research at Mary Baldwin College, Staunton, Virginia, USA (Visiting Scholar, June 15–July 31, 2010): Cold War Rationality

Ursula Klein, Prof. Dr., Außerordentliche Professorin an der Universität Konstanz (Research Scholar, since July 1, 1998): History of the Laboratory Sciences in the Context of Application

Jana Klenhova, Institut für Slawistik, Humboldt-Universität zu Berlin (Predoctoral Research Fellow, August 1, 2010–January 31, 2011): Asynchronicity — The Soviet Audiovision (1925–1934)

Falk-Juri Knauff, Dr. forest. Dipl.-Forstwirt (Research Scholar, September 1, 2008–December 31, 2011): Geo Information System, WebGIS

Johannes Knolle, (Predoctoral Research Fellow, May 1–May 31, 2010)

Alexei Kojevnikov, Ph. D., Associate Professor of History, University of British Columbia, Canada (Visiting Scholar, November 1, 2010–February 28, 2011): “Knabenphysik”: Postdoctoral Revolution and the Birth of Quantum Mechanics

Peter Konen, University of Regensburg (Predoctoral Research Fellow, March 1–August 31, 2010): Education and Training of Mining Experts in the Habsburg Monarchy, 1763–1848

Georg Kopsky, Institute of History, University of Vienna, Austria (Predoctoral Research Fellow, March 1–April 30, 2012): The Development of Modern Mathematical Physics in the Second Half of the 20th Century

Diana L. Kormos-Buchwald, Ph. D., Professor of History. General Editor and Director, The Einstein Papers Project. (Visiting Scholar, September 1–October 11, 2011): The Collected Papers of Albert Einstein. The Berlin Years 1923–1925.

Pamela Kort, Dr. (Curator in Residence, January 11–March 31 and August 1–September 30, 2010, August 1–September 30, 2011): The Scientific Imagination: Art, Science, and Fiction 1863–1969

Fabian Krämer, Ludwig-Maximilians-Universität München (Predoctoral Research Fellow, September 1, 2006–February 28, 2011): How Did a Centaur Get to Early Modern London? Observation and Reading in the European Study of Nature, ca. 1550–1750

Markus Krajewski, Dr. phil., Associate Professor of Media History at Bauhaus-University Weimar (Visiting Scholar, April 15–July 15, 2011): History and Theory of Exactness / Precision in the Humanities and Sciences; Digital Humanities

Arie Krampf, Ph. D. (Postdoctoral Research Fellow, July 1, 2008–September 30, 2010): Transfer and Localization of Economic Knowledge in the Twentieth Century

Karin Krauthausen, Dr. des. (Postdoctoral Research Fellow/Visiting Scholar, April 1, 2008–February 18, 2013): Paul Valéry’s Cahiers: Drawing and Writing as a Practice of Thought

Richard Kremer, Ph. D., Associate Professor of History, Dartmouth College, USA (Visiting Scholar, January 1–June 30, 2011): Tables, tabular formats and the structuring of astronomical knowledge

Katharina Kreuder-Sonnen, Justus-Liebig-Universität Gießen (Predoctoral Research Fellow, November 1, 2012–March 31, 2013): How to Make Microbes Travel. Bacteriological Knowledge Transfer to and Within Poland, 1885–1939

Harun Küçük, University of California, San Diego (Predoctoral Research Fellow, January 1–June 30, 2012): Early Enlightenment in Istanbul

Ursula Kundert, PD Dr., Akademische Rätin auf Zeit im Fach Deutsche Literatur des Mittelalters und der frühen Neuzeit an der Christian-Albrechts-Universität zu Kiel (Research Scholar, January 1–April 30, 2010): Seriality in Medieval Literature

Julia Kursell, Dr. phil. (Research Scholar, Dilthey Fellow, Visiting Scholar, April 1, 2004–January 31, 2013, partly funded by the Volkswagenstiftung and the Bauhaus-Universität Weimar): Historical Epistemology of Hearing (1850-2000)

Ulla Kypta, Universität Frankfurt/M (Predoctoral Research Fellow, January 1–June 30, 2012): Knowing. Learning. Ruling. The Development of a Special Language in 12th Century Pipe Rolls.

Pierre-Yves Lacour, Ph. D. (Postdoctoral Research Fellow, January 1–March 31, 2011): Encyclopedism and the Emergence of Disciplines

Lucie Laplane, Université Paris Ouest Nanterre La Défense (Predoctoral Research Fellow, April 15–May 15, 2010): The Emergence of the Cancer Stem Cell Concept

Manfred Laubichler, Ph. D., Professor of Theoretical Biology and History of Biology at the Arizona State University (Visiting Scholar, May 7–July 31, 2012)

Mike Laufenberg, Technische Universität Berlin (Predoctoral Research Fellow, August 5, 2009–October 31, 2010, funded by the Hans Böckler Stiftung): The Government of Sexuality: Subjectivity, Truth, and Power in the Age of Biology

Adam Lawrence, University of California, Los Angeles, USA (Predoctoral Research Fellow, October 1, 2011–August 31, 2012 and April 1–August 31, 2012): All Against All: Scientific Prophecies of Food and Fuel Production, 1929–1989

Sophie Ledebur-Wicheln, Universität Wien, Austria (Predoctoral Research Fellow, October 1, 2010–January 31, 2011): Psychiatry as Science of Custodial Care of the Edge of the City? The Lower Austrian Mental Institution “Am Steinhof” from its Founding (1907) until the Early 1930’s

Christian Leduc, Ph. D. (Postdoctoral Research Fellow, October 1–November 30, 2011): Methodology in Leibniz and the German Enlightenment

Clarissa Lee, Program in Literature, Duke University (Predoctoral Research Fellow, July 3–September 9, 2012)

Wolfgang Lefèvre, Dr., Außerordentlicher Professor an der Freien Universität Berlin (Research Scholar, July 1, 1994–February 28, 2006, associated): History of Science in Connection with History of Philosophy on the Basis of Social History; Sciences in Greek Antiquity; Early Modern Physics and Chemistry; History of Biology (15th–18th centuries)

Ageliki Lefkadiou, Ph. D. (Visiting Scholar, December 10, 2011–January 14, 2012): Reformulating Race: The Visualization of Human Diversity in Greek Primary School Science Textbooks

Katrin von Lehmann, Artist in Residence, September 1–December 31, 2012

Christoph Lehner, Ph. D. (Research Scholar, January 1, 2004–December 31, 2014, funded by the GIF and the DFG): History and Philosophy of Modern Physics

Rebecca Lemov, Ph. D., Assistant Professor of the History of Science, Harvard University (Visiting Scholar, June 15–July 31, 2010 and August 24, 2010–June 14, 2011): Database of Dreams: Making a Science of the Human, 1941–1962

Kirsten Leng, Ph. D., SPAN, Northwestern University, IL, USA (Postdoctoral Research Fellow, June 1–July 31, 2012): Contesting the ‘Laws of Life’: Sexual Science and Sexual Politics in the Early Twentieth Century

Elaine Leong, D. Phil. (MPG Minerva Research Group Leader, September 1, 2012–August 31, 2017): Reading and Writing Medicine in Early Modern England

Karin Leonhard, Dr. (Research Scholar, October 1, 2011–September 30, 2014)

Liang LI, Ph. D. (Postdoctoral Research Fellow, November 7, 2011–January 5, 2012): Western Astronomical Knowledge in Later Ming and Earlier Qing China

Veronika Lipphardt, Dr., Professor of History of Knowledge, Friedrich Meinecke Institute, Freie Universität Berlin. (Research Group Director, March 1, 2009–April 30, 2016): Knowledge about Human Biological Diversity in the 20th Century

Ximo Guillem Llobat, Ph. D. (Postdoctoral Research Fellow, October 1, 2009–March 31, 2010)

William Lockhart, Humboldt-Universität zu Berlin (Predoctoral Research Fellow, October 1, 2008–August 31, 2012): Listening to the Domestic Music Machine: Keyboard Arrangement in the Nineteenth Century

Ilana Löwy, Prof. Dr., Centre de Recherche Médecine, Science, Santé et Société (CERMES- site CNRS), Villejuif, France (Visiting Scholar, October 1–November 30, 2011): Dismorphology's Archives: Collecting and Processing Data on Inborn Anomalies.

Carlos López Beltrán, (Visiting Scholar, October 1, 2006–March 31, 2007)

Martin Lücke, Dr., Univ.-Prof. für Didaktik der Geschichte an der Freien Universität Berlin (Visiting Scholar, August 7–September 24, 2012, funded by the FU Berlin): Wachstum — Eine Wissenskritik

Hannah Lotte Lund, (Research Scholar, September 1, 2005–October 31, 2010): Berlin Jewish Salons Coordination of the Network *History of Scientific Objects*

Nimrod Luz, Ph. D., Assistant Professor at the Department of Sociology and Anthropology, Western Galilee College , Akko, Israel (Visiting Scholar, August 2–September 3, 2010, funded by the Alexander-von-Humboldt-Stiftung): Capital Cities during the Pax Mongolica Era. Artifacts, institutions, technologies and cross cultural influences. From Cairo to Daidu

Harro Maas, Ph. D., Associate Professor for Economy at the University of Amsterdam (Visiting Scholar, April 15–June 30, 2010, funded by the Netherlands Science Foundation Fund): Representational Practices in Economics

Rui Magone, Ph. D. (Postdoctoral Research Fellow, March 1, 2009–April 30, 2010): Social mobility and professional diversification in late imperial China; archival practices in the Forbidden City

Irad Malkin, Ph. D., Professor and Director, Center of Mediterranean Civilizations, Tel Aviv (Visiting Scholar, May 1–May 31, 2011)

Marlene Manoff, Ph. D., MIT (Visiting Scholar, March 1–March 31, 2011): Capitalizing on the Archive: Bibliographic Control in a Corporate Age

Maria do Mar Gago, (Visiting Scholar, August 19–September 19, 2010): The Scientific Life under the New State: J. A. Serra's Genetics' Laboratories and the Political Economy of Portuguese Fascism (1946–1974)

Oana Mateescu, University of Michigan (Predoctoral Research Fellow, May 1–May 31, 2011, funded by the New Europe College): Evidence and Anachronism: Interdisciplinary Debates on Communal Ownership in Romania

Gisela Mateos, Ph. D. (Visiting Scholar, July 1–August 31, 2010)

Angela Matyssek, Dr., wissenschaftliche Mitarbeiterin Philipps-Universität Marburg (Visiting Scholar, February 1–March 31, 2010): Theories and Practices of the Original in Contemporary Art

Andreas Mayer, Dr. (Research Scholar, March 1, 2007–April 30, 2013, funded by the Fritz-Thyssen-Stiftung 2010–12): *Dream Watchers: A History of Modern Dream Research*

Thomas Mayer, Institut für Zeitgeschichte, Universität Wien, Austria (Predoctoral Research Fellow, June 4–August 31, 2012)

Francis McKay, University of Chicago (Predoctoral Research Fellow, April 1–June 30, 2010): *The Anthropology of Spiritual Exercises*

Peter McLaughlin, Dr. phil., Professor für Philosophie, Universität Heidelberg (Visiting Scholar, since July 1, 2004): *History of Mechanics. Aristotle’s “mechanical questions” in 16th and 17th century mechanics*

Megan McNamee, University of Michigan, USA (Predoctoral Research Fellow, July 1–September 30, 2012, and September 1, 2012–August 31, 2013, funded by the Mellon Dissertation Competition Fellowship): *Picturing Number: Visualizing Quadrivial Concepts in the Central Middle Ages*

Andrew Mendelsohn, Ph. D., Professor Imperial College, London (Visiting Scholar, September 1–September 30, 2012): *How Physicians Knew: Medical Knowledge and Paper Technology, 1550–1950*

Angelika Messner, Dr. habil., Assistant Professor of Sinology, University of Kiel, Germany (Postdoctoral Research Fellow, October 1–December 31, 2010): *Shifting Knowledge Practices and Storage Devices in 16th and 17th Century Technique-texts (Ming-Qing China)*

Robert Meunier, Ph. D. (Predoctoral Research Fellow, January 1–April 30, Postdoctoral Research Fellow May 1–June 30, 2012): *Individuals and Types. From Constitutional Medicine to Personalized Medicine.*

Sophie Meyer, M. A. (Predoctoral Research Fellow, July 1, 2011–June 30, 2013): *Tumor Immunology in Berlin-Buch, 1961–1985*

Charles Midwinter, University of Minnesota, Program in the History of Science, Technology, and Medicine (Predoctoral Research Fellow, June 23–August 4, 2010)

Erika Lorraine Milam, Ph. D., Associate Professor, Princeton University (Postdoctoral Research Fellow, June 15–August 15, 2010): *Barely Human: The American Search for Human Nature in the Long 1960s*

David Marshall Miller, Ph. D., Visiting Assistant Professor of Philosophy and History, Duke University, Durham, USA (Postdoctoral Research Fellow, July 1–August 15, 2011): *From Centers to Lines: The Spatial Frameworks of Early Modern Physics*

Thomas Ross Miller, Ph. D., Professor of Liberal Arts, Berkeley College, Adjunct Instructor, New York University, USA (Visiting Scholar, February 1–February 29, 2012): Corporealism: Sensory Classification, Embodied Knowledge, and the Origins of Anthropology

Christopher Minkowski, Ph. D., Boden Professor of Sanskrit, University of Oxford, UK (Visiting Scholar, July 6–August 17, 2012): Extreme Commentary in Sanskrit and the General Problem of Overinterpretation

Teru Miyake, Stanford University, USA (Predoctoral Research Fellow, February 1–June 30, 2011): Underdetermination, Decomposition, and the A Priori

Paola Molino, Ph. D. (Postdoctoral Research Fellow, July 1–August 31, 2012): A Guide Through Textual Practices in late Renaissance Court Libraries: Hugo Blotius' Catalogue De Turcis et Contra Turcas

Arturo Montoto Echevarría, (Visiting Scholar, September 17–October 22, 2011) Thomas Morel, Université Bordeaux 1, France (Visiting Scholar, July 1–August 13, 2010): Mathematical Institutions and Scientific Policies in France and Germany during the First Half of the Nineteenth Century

Amos Morris-Reich, Ph. D., Director Bucerius Institute for Research of German History and Society, The University of Haifa, Israel (Visiting Scholar, July 1–July 31, 2010): Race and Humanism: The Epistemology of Arthur Ruppin

Glenn W. Most, Ph. D., Professore Ordinario di Filologia Greca, Scuola Normale Superiore di Pisa, Visiting Professor of Social Thought and of Classics, University of Chicago (External Scientific Member, since November 19, 2010): Etymology and Allegoresis in the Ancient Greek Scholarly Traditions

Bernardo Mota, Ph. D., Assistant Professor of Classics, University of Lisbon, Portugal (Postdoctoral Research Fellow, October 15–November 30, 2010, May 1–August 31, 2011, funded by the Alexander-von-Humboldt-Stiftung): The Status of Mathematics and the Making of Modern Science

Staffan Müller-Wille, Dr. phil. Senior Lecturer, University of Exeter (Visiting Scholar, August 1–31, 2010, April 1, 2011–June 30, 2012): Rewriting the System of Nature: Linnaeus's Use of Writing Technologies

John Mumma, Ph. D. (Postdoctoral Research Fellow, October 1, 2011–March 3, 2012): Concrete figures and abstract spaces: the differing conception of geometry in Berkeley and Reid

Tania Munz, Ph. D. (Research Scholar, August 1, 2007–August 31, 2010): The Dancing Bees: Karl von Frisch and the Discovery of the Honeybee Dance Language

Caitlin Murdock, Ph. D., Associate Professor of Modern Central European History, California State University Long Beach (Visiting Scholar, March 1–May 31, 2010): Radiant Exposure and the Politics of Public Health in 20th Century Central Europe

Anindita Nag, Ph. D. (Postdoctoral Research Fellow, September 1, 2010–June 30, 2011): Documenting Destitution: Photography and the Visual Archive of Famine in India

Carla Nappi, Ph. D. Canada Research Chair and Assistant Professor, University of British Columbia (Visiting Scholar, January 1–June 30, 2010): Epistemologies of Exchange: Science and Medicine on the Borderlands of Early Modern China

Susan Naquin, Ph. D., Professor of History and East Asian Studies, Princeton University (Visiting Scholar, February 1–June 30, 2011): The Material Culture of Temples in North China, 1400–1900

Omar W. Nasim, Ph. D., Senior Research Fellow, ETH Zürich (Postdoctoral Research Fellow, April 1–July 31, 2010 and August 1–August 31, 2011): Scientific Observation, Perception, and Epistemology, c. 1850–1915

Jaume Navarro, Ph. D. (Visiting Scholar, January 1, 2009–July 31, 2011, funded by the Alexander-von-Humboldt-Stiftung): Early Quantum Physics in Britain

Dalia Neis, (Predoctoral Research Fellow, April 12–July 15, 2012)

Alondra Nelson, Ph. D., Associate Professor of Sociology at Columbia University, USA (Visiting Scholar, December 31, 2010–January 28, 2011): Slavery, Memory, and the Social Life of DNA

Sean Nelson, University of Southern California, Los Angeles (Predoctoral Research Fellow, April 1–April 30, 2012): Antonio de' Medici and the Art of Alchemy

András Németh, Ph. D. (Research Scholar, September 1, 2011–August 31, 2013): Textual Practices and Canon Formation at the Byzantine Court

Elio Nenci, Dr. phil. (Visiting Scholar, July 1, 2009–November 30, 2010): The Relationship Between Scientific Reflection and Practical Knowledge During the Renaissance and the First Decades of the 17th Century: The Case of Hydraulic Machines

Basan Nergui, Ph. D., Professor (Visiting Scholar, September 15–October 15, 2010)

Elizabeth Neswald, Ph. D., Associate Professor, Brock University (Visiting Scholar, July 1–December 31, 2010, August 1–August 31, 2012, partly funded by the Brock University / Canadian Institutes for Health Research): Counting Calories: Thermodynamics, Statistics, and the Emergence of Modern Nutrition Science

Sylvie Neven, Ph. D. (Visiting Scholar, Intermittently since October 2011): From Cennini to De Mayerne. Artists' recipes of painting materials and techniques, 1400–1650

Christer Nordlund, Ph. D., Professor of History of Science and Ideas, Umeå University (Visiting Scholar, September 1, 2010–July 31, 2011): Peat Bogs as Biological Archives: Lennart von Post and the Development of Pollen Statistics During World War I

Horst Nowacki, Dr.-Ing., Dr. h.c., Prof. em. of ship design (Visiting Scholar, since August 1, 2001): Publications on the history of ship theory and ship design (Archimedes, Euler, Bouguer)

Zoe Nyssa, University of Chicago (Predoctoral Research Fellow, September 1–December 31, 2010): Studying Biodiversity, Saving Biodiversity: Expert Practices and Public Engagements in Conservation Biology

Christine von Oertzen, PD Dr. (Research Scholar, since June 15, 2005): The Science of Statistics and the Politics of Censustaking; Early Childhood Development Studies in 19th-Century America

Pietro Daniel Omodeo, Ph. D. (Postdoctoral Research Fellow/Research Scholar, November 1, 2010–June 30, 2016): Transformation of cosmological models from Antiquity up to the Copernican turn and beyond; history of natural philosophy; the philosophical and scientific culture of the Renaissance

Lisa Onaga, Cornell University (Predoctoral Research Fellow, July 1–October 31, 2010): Silkworm Seeds: A Cultural History of Sericulture and Genetics in Imperial Japan

Javier Ordóñez Rodríguez, Ph. D., Professor of History of Science at the Faculty of Philosophy and Letters of the Autonomous University of Madrid (Visiting Scholar, February 1, 2009–February 1, 2010): Studies on War and Science. Consequences of the Standardization in the German Science and Industry between 1880 and 1914 in Subsequents War in Europe

Francisco Javier Guerrero Ortega, Dr. phil., Professor at the Institute for Social Medicine, State University of Rio de Janeiro (Visiting Scholar, June 25–July 31, 2010): History of the body, history of the self

Laura Otis, Ph. D., Professor of English, Emory University, Atlanta, USA (Visiting Scholar, December 9, 2009–January 12, 2010, September 15, 2010–August 31, 2011, and May 12–August 12, 2012): Individual Variations in Cognitive Style: Beyond the Word/Image Divide

Christine Ottner-Diesenberger, Ph. D., Institut für Kulturwissenschaften und Theatergeschichte der Österreichischen Akademie der Wissenschaften, Wien, Österreich (Visiting Scholar, May 1–July 31, 2011): Historical Research in the 19th Century: Programs and Procedures at the Imperial Academy of Sciences in Vienna

Anne Overbeck, Emmy-Noether-Research Group, University of Münster, Germany (Predoctoral Research Fellow, October 1–December 31, 2012): Eugenics and the Discourse on Reproductive Rights of African American Women in the Twentieth Century

José M. Pacheco, Ph. D. Professor for Applied Mathematics at the University of Las Palmas de Gran Canaria (Visiting Scholar, February 15–May 15, 2012): Complexity and Uncertainty in Climate Models

Cathleen Paethe, Friedrich-Alexander-Universität Erlangen-Nürnberg (Visiting Scholar, June 1, 2010–May 31, 2013, funded by the Deutsche Forschungsgemeinschaft): The bibliophile Qi Chenghan: book consumption and commercialization in late Ming China (1550–1644)

Harriet Palfreyman, Department of History, University of Warwick (Predoctoral Research Fellow, November 1–December 31, 2011): Visualizing the Pox in London c. 1780–1860

Katharine Park, Ph. D., Professor for History of Science, Harvard University (Visiting Scholar, October 1, 2012–August 31, 2013, funded by the Harvard University and the MPIWG): Knowledge on the Move: Scientific Encounters in the Muslim and Christian Worlds, 500–1500

Giuditta Parolini, (Predoctoral Research Fellow, October 1–November 30, 2011): Statistics and Computing in Agriculture and Biology in Britain, 1920s–1960s

Anna Perlina, Excellence Cluster 264 „Topoi“ (Predoctoral Research Fellow, September 1, 2008–June 30, 2012): Contexts and Transformations of Social Psychology: Between Academic Culture and Socio-Economic Application

Dominique Pestre, Professor, Ecole des Hautes Etudes en Sciences Sociales, Paris, France (Visiting Scholar, August 1, 2012–June 30, 2013): Government of Technology

Heather Peterson, Ph. D. (Postdoctoral Research Fellow, January 15, 2010–January 14, 2011): Essential Differences: Body and Place in the Early Modern Atlantic

Marissa Helene Petrou, University of California, Los Angeles (Predoctoral Research Fellow, October 1–December 31, 2010): A Discipline of Collection: Founding the Dresden Museum for Zoology, Anthropology and Ethnography, 1875–1914

Jahnvi Phalkey, Ph. D. (Visiting Scholar, July 1–August 31, 2010): History of Scientific Instruments and Practices in India 1930–1970: A Study of Select Accelerator Facilities

Kim Plofker, Ph. D., Assistant Professor of Mathematics, Union College, Schenectady, USA (Visiting Scholar, September 1–December 31, 2012, funded by the Union College): The Development of Computational Procedures and Numerical Tables in Sanskrit Mathematics in the second Millennium

Tino Plümecke, Technische Universität Berlin (Predoctoral Research Fellow, November 1, 2010–February 28, 2011): Diversity Research in the Life Sciences: Geneticization of Race in the 21st Century and Modernization of Race Concepts in Areas of (Post) Genomics

Christopher Plumb, University of Manchester (Predoctoral Research Fellow, September 1, 2009–February 28, 2010): Exotic animals in eighteenth-century Britain

Irina Podgorny, Ph. D. (Research Scholar, October 1, 2009–January 31, 2011): History of Paleontology, Museums of Natural History, Archaeological Ruins

Filippomaria Pontani, Ph. D., Associate Professor, University of Venice, Italy (Visiting Scholar, July 6–August 17, 2012): Inimitable Sources: Canonical Texts and Rhetorical Theory in the Greek, Latin, Arabic and Jewish Traditions

Marcus Popplow, Dr. (Visiting Scholar, October 1–December 31, 2009): Early Modern Engineering Technology.

Sandra Pravica, M. A., Freie Universität Berlin (Predoctoral Research Fellow, September 1, 2011–August 31, 2012): Tentative Transgressions. Gaston Bachelard's Experimental Epistemology

Albert Presas i Puig, Dr. (Research Scholar, August 12, 2008–September 30, 2010): Scientific relationship between Germany and Spain: Science, Technological Transfer, and International Policy in the 20th Century

Valentina Pugliano, (University of Oxford (Mansfield College), Predoctoral Research Fellow January 1–July 31, 2012, Postdoctoral Research Fellow August 1–December 31, 2012): Role of Craftsmen and Artisans in the Natural Historical Collections of Sixteenth-Century Venice

Gregory Radick, Ph. D., Senior Lecturer in History and Philosophy of Science, University of Leeds, UK (Visiting Scholar, March 14–March 28, 2010): Observations of Animal Behaviour and the Assessment of Claims about Animal Semantics

Joanna Radin, University of Pennsylvania, USA (Predoctoral Research Fellow, June 1–August 31, 2011): *Life on Ice: Frozen Blood, Human History and Biodiversity in Genomic Age, 1958–2010*

F. Jamil Ragep, Professor, Director of the Institute of Islamic Studies, McGill University, Canada (Visiting Scholar, July 1–July 31, 2010): *Islamic Scientific Manuscripts Initiative (ISMI) Project*

Dhruv Raina, PhD., Heinrich Zimmer Professor of Indian Philosophy and Intellectual History, Ruprecht-Karls-Universität Heidelberg (Visiting Scholar, February 13–March 12 and June/July 2011): *Jesuit Astronomy in India*

Brigit Ramsingh, University of Toronto (Predoctoral Research Fellow, March 1–August 31, 2010): *International Food Safety Standards, 1955–1995*

João Rangel de Almeida, Ph.D. (Postdoctoral Research Fellow, September 10–June 30, 2013): *Empires of Health and the Epidemic Governance of the Modern World*

José Emmanuel Raymundo, Ph.D., Assistant Professor, Department of Communication, Tulane University, New Orleans, USA (Visiting Scholar, June 1–July 31, 2012): *Dangerous Bodies, Dangerous Cities.*

Carsten Reinhardt, Dr., Professor at the Institute for Science and Technology Studies, University of Bielefeld (Visiting Scholar, September 1, 2010–January 31, 2011, April 1–July 31, 2011, October 1, 2011–October 31, 2012): *History of the Max Planck Institute for Chemistry*

Christian Reiß, Friedrich-Schiller-Universität Jena (Predoctoral Research Fellow, July 1, 2007–December 31, 2010): *The Way to the Laboratory — Origin and Role of Organisms in Experimental Systems in Early Life Sciences*

Jürgen Renn, Dr., Honorary Professor for the History of Science at the Humboldt-University Berlin, Honorary Professor for Physics at the Free University Berlin, Adjunct Professor for Philosophy and Physics at the Boston University (Director, since March 1, 1994): *History of Early Modern Mechanics, History of Relativity Theory; Interaction between Cognitive and Contextual Factors in the History of Science.*

Maria Rentetzi, Ph. D., Assistant Professor in Sociology of Science at the National Technical University of Athens (Visiting Scholar, June 1–July 31, 2010, June 1–August 31, 2011, and June 1–July 15, 2012): *Radium Emanations and Male Sexuality in 20th-Century America*

Andrew Reynolds, Ph. D., Associate Professor, Department of Philosophy & Religious Studies, Cape Breton University, Canada (Visiting Scholar, September 1–September 30, 2011): *Models and Metaphors in Cell Communication Research*

Hans-Jörg Rheinberger, Dr., Honorarprofessor für Wissenschaftsgeschichte an der TU Berlin, Dr. h.c. ETH Zürich (Director, since January 1, 1997): Epistemology of Experimentation

Dean Rickles, Ph.D., Arc Senior Australian Research Fellow, University of Sydney (Postdoctoral Research Fellow, October 14–November 11, 2010): The Development of Quantum Gravity

Simone Rieger, (Academic Officer, March 1, 2008–February 28, 2013, funded by the MPG): Open Access Initiative “European Cultural Heritage Online” (ECHO)

Marlise Rijks, (Predoctoral Research Fellow, June 1–October 31, 2012): Art, Optics, and Practical Mathematics. Artists’ Collections in the Early Modern Netherlands

Harriet Ritvo, Ph. D., Arthur J. Conner Professor of History at the Massachusetts Institute of Technology (Visiting Scholar, January 9–February 9, 2012): Making Animals Wild

Volker Roelcke, Professor für Geschichte der Medizin, Direktor des Instituts für Geschichte der Medizin der Universität Gießen (Visiting Scholar, May 1–August 31, 2010): Transitions From Animal to Human Experiment in Medical Research, ca. 1880–1960

Sophia Roosth, Program in History, Anthropology, Science, Technology, and Society, Massachusetts Institute of Technology (Predoctoral Research Fellow, February 1–July 31, 2010): Crafting Life: A Sensory Ethnography of Constructive Biologies

Ricardo Roque, Ph. D. (Visiting Scholar, October 1–October 26, 2012): Land, Bodies and Race Lines: Colonial Anthropology and Political Geography in Timor

Raja Rosenhagen, Zentrum für Logik, Wissenschaftstheorie und Wissenschaftsgeschichte, Universität Rostock (Predoctoral Research Fellow, October 1, 2009–June 30, 2010): Individual Experience and its Role in the Transformation of Knowledge Systems

Christoph Rosol, M. A., Bauhaus University Weimar (Predoctoral Research Fellow, January 1, 2012–June 30, 2013): Circulations of Knowledge in the History of Climate Modeling

Sophie Roux, Dr., Maitre de conférences, Université Grenoble II (Visiting Scholar, April 1–May 31, 2010, funded by the Institut universitaire de France): Edition of Galileo’s *Mechaniche*

Bruce Rusk, Ph. D., Assistant Professor of Chinese Literature at Cornell University (Visiting Scholar, January 1–June 30, 2010): Relationship Between Text and Object in Authentication and Production of Culturally Important Artefacts, Especially Bronzes Vessels Attributed to the Early Ming Dynasty

David Sabean, Ph. D., Distinguished Professor of History & Henry J. Bruman Endowed Chair in German History, University of California, Los Angeles (Visiting Scholar, May 1–May 31, 2012, July 10–August 10, 2012)

Carola Sachse, Dr., Professorin für Zeitgeschichte, Universität Wien (Visiting Scholar, June 1–September 30, 2010, July 1–September 30, 2012)

Neil F. Safier, Ph. D., Assistant Professor of History, University of British Columbia (Visiting Scholar, April 25–June 24, 2010): Translating Observations: Lisbon's Arco do Cego Printing House (1799–1801), Imperial Science, and Atlantic Agro-economy at Enlightenment's End

Donald Salisbury, Ph. D., Professor of Physics, Austin College, Texas (Visiting Scholar, June 4–August 14, 2011, June 30–August 7, 2012): Roots of Quantum Gravity Research

Imad Samir, Ph.D., Assistant Professor at the University of Damascus, Syria (Visiting Scholar, November 14, 2012–May 31, 2013): Cuneiform Texts from Ebla (Third Millenium B.C.)

Eric Savoth, University of California, Berkeley (Predoctoral Research Fellow, July 15–August 22, 2011): Lebensphilosophie and the Life Sciences in Early Twentieth-Century Germany

Dagmar Schäfer, PD Dr. (Research Group Director, May 1, 2006–September 30, 2011): Concepts and Modalities. Practical Knowledge Transmission

Matthias Schemmel, Dr. (Research Scholar, since July 1, 2003): Long-term development of spatial cognition; history of early modern mechanics; history of modern physics and astronomy; history of Chinese science

Wulf Schiefenhövel, Dr., Prof. em., Human Ethology Group, MPI for Ornithology (Visiting Scholar, February 10–March 7, 2010): Spatial Practices and Languages in Non-literate Societies: A Comparison between EIPO and DENE

Arne Schirrmacher, Dr. (Research Scholar, December 1, 2009–November 30, 2010): History of 20C science communication; History of quantum physics

Wolfgang Schivelbusch, Ph. D. (Visiting Scholar, July 1–August 31, 2011): Historizing Concepts of Air

Thomas Schlich, Dr. med., Associate Professor at McGill University (Visiting Scholar, September 1, 2009–August 31, 2010, funded by the McGill University):
History of Modern Surgery

Martina Schlünder, Ph.D. (Postdoctoral Research Fellow, November 1, 2011–December 31, 2012): Populations and Persons in Biomedicine. Negotiating Difference in Clinical Practices

Florian Schmaltz, Ph.D. (Postdoctoral Research Fellow, November 1, 2012–April 30, 2013): Fluid Mechanics in Times of War: Research Practices interacting Politics, Industry and the Military

Henning Schmidgen, Dr. phil. (Research Scholar, July 1, 2006–March 31, 2011):
Machines and Bodies Without Organs in the History of Science

Wolfgang Schmidle, Dr. (Research Scholar, September 1, 2008–August 31, 2011):
Max Planck Digital Library

Urs Schoepflin, Dipl. Soz. (Head of the Library, since September 1, 1994): Scientific Information Systems, Scientific Communication, Sociology and History of Science, Scientometrics.

Peter Schöttler, Dr. phil., Directeur de recherche, CNRS, Institut d'histoire du temps présent, Paris ; Honorarprofessor für Neuere Geschichte an der Freien Universität Berlin (Visiting Scholar, May 1, 2008–December 31, 2012): Marc Bloch and Scientism

Katharina Schramm, Ph.D., Research Associate, Max Planck Fellow Group „Law, Organisation, Science and Technology“, Max-Planck-Institut für Ethnologische Forschung (Visiting Scholar, February 7–April 7, 2011 and April 10–May 6, 2012):
New Genetics, Old Identities? The Impact of Science on Notions of Race, Ethnicity and Citizenship in South Africa

Volkmar Schüller, Dr. (Research Scholar, September 15, 1994–March 31, 2012):
History of Mathematics and Physics (16th and 17th Centuries).

Jeffrey Schwegman, Ph.D. (Postdoctoral Research Fellow, October 1, 2008–September 30, 2010): Philosophical Practices in the French Enlightenment

Alexander von Schwerin, Dr. (Postdoctoral Research Fellow, March 1–May 31, 2012): Variabilität des gefährdeten Körpers

David Sepkoski, Ph.D. (Visiting Scholar September 1–December 31, 2011, Research Scholar, September 1, 2012–August 31, 2015): A Natural History of Data; Extinction and the Value of Diversity

Norberto Serpente, Wellcome Trust Centre for the History of Medicine at UCL (Predoctoral Research Fellow, January 1–July 31, 2010): The Visualisation of the Invisible in Cell Biology: The Use of Models Describing Cell Function as a Consequence of the Molecular Revolution (1970–2000)

Elena Serrano, Ph. D. (Postdoctoral Research Fellow, September 1, 2012–August 31, 2014): Science for Women in the Spanish Country House (1780–1808)

William R. Shea, Ph. D., Galileo Professor of History of Science, University of Padua, Italy (Visiting Scholar, September 1–September 30, 2012)

Grace Yen Shen, Ph. D. (Postdoctoral Research Fellow, August 1, 2009–August 31, 2011): Song to mid-Qing coal culture: Cultural Identity and Innovation

Yunli SHI, Prof., Executive Director Department of History of Science and Scientific Archaeology (Visiting Scholar, September 1–October 31, 2010, funded by the Max Planck Society China Cooperation): Craft Knowledge, Experimentation, and Theory Construction

H. Otto Sibum, Dr., Hans Rausing Professor of History of Science & Director, Office for History of Science, Uppsala University (Visiting Scholar, June 1–August 15, 2010, October 15–December 31, 2011)

Harald Siebert, Ph. D., Visiting Professor, History of Science, Université de Versailles-Saint-Quentin-en Yvelines, France (Visiting Scholar, April 1–August 31, 2012): Johannes Hevelius (1611–1687) Correspondence Project

Skúli Sigurdsson, Ph. D. (Rathenau Senior Fellow, since April 1, 2007): History of science after 1800: mathematics, physical sciences, philosophy; History of technology: electric power, energy and power, technological systems, technology in museums; History of biotechnology: databases, civil liberties, stock market, bioethics.

Ineke Sluiter, Ph. D., Professor and Chair of Greek Literature and Linguistics, University of Leiden, Netherlands (Visiting Scholar, July 6–August 17, 2012): Obscurity

Tzveta Sofronieva, (Author in Residence, November 1, 2010–December 31, 2011): Eigen Schwingungen Welt

Jennifer Spinks, Ph. D. (Postdoctoral Research Fellow, January 2–February 28, 2012, funded by the DAAD): Comets and Wondrous Signs in the Sky: Natural History and Religious Polemic in Early Modern Germany and France

John Stachel, Ph. D., Professor (Visiting Scholar, June 7–June 30, 2012): History of Quantum Gravity Project; English Edition of Publication: Einstein

Max Stadler, Ph. D. (Postdoctoral Research Fellow, October 1, 2009–December 31, 2010): Membranous Things. The Material Science of the Cell, 1920–1960

Frank Stahnisch, Dr. med., Associate Professor at the University of Calgary (Visiting Scholar, April 15–August 15, 2010): The Making of a New Research Field: On the Pursuit of Interdisciplinarity in the German Neuromorphological Sciences, 1910–1945

Marius Stan, Ph. D., Postdoctoral Instructor, CalTech (Postdoctoral Research Fellow, July 1–August 31, 2011): Philosophical foundations of physics in Kant and his predecessors

Jacqueline Stedall, Ph.D., Senior Research Fellow, The Queen’s College, Oxford (Visiting Scholar, October 12–November 30, 2011, funded by the DAAD): Harriot online

Claudia Stein, Dr., Associate Professor, University of Warwick (Visiting Scholar, January 1–June 30, 2013, funded by the University of Warwick): Breeding for the Fatherland: Bodies, Population and Politics in Enlightened Absolutist Germany

Alma Steingart, Massachusetts Institute of Technology, Cambridge, USA (Predoctoral Research Fellow, September 1, 2012–August 31, 2013): Conditional Inequalities: American Pure and Applied Mathematics from the Cold War to the Present

Catherine Stinson, University of Pittsburgh, USA (Predoctoral Research Fellow, October 1, 2010–February 28, 2011): Computational Models as Experimental Systems

Thomas Sturm, Dr. phil., Ramon y Cajal Research Scholar, Dept. de Filosofia y CEHIC, Universitat Autònoma de Barcelona, Spain (Research Scholar, June 15–July 23, 2010): Rationality in Philosophy and Psychology; Perceptual Illusions; Crisis Debates in Psychology; Kant and the Human Sciences

Xiaochun SUN, Ph. D., Profesor for History of Science at the Chinese Academy of Science (Visiting Scholar, August 20–August 31, 2010)

Fenneke Sysling, (Predoctoral Research Fellow, June 4–July 7, 2012): Disembodied and Re-embodied Knowledge. Physical Anthropology in the Netherlands Indies, ca. 1880–1960

Amir Teicher, Tel-Aviv University (Predoctoral Research Fellow, July 19–September 9, 2012): Statistics on Mental Illnesses among Jews in Germany, before and after 1945

Pierre Teissier, Dr. (Université Paris Ouest Nanterre) (Postdoctoral Research Fellow, January 1–April 30, 2010): Contribution to the history of electric cars since the 1950s; Comparison France-Germany; Techno-politics, scientific and techno-scientific objects

Martin Thiering, Ph. D., TOPOI Research Group E II (Excellence Cluster 264) (Visiting Scholar, September 14, 2008–January 31, 2013): Cognitive Linguistics, Cognitive Anthropology, Spatial Language and Concepts of Space, Topological Relations, Semiotics, History of Linguistics, Philosophy of Language, Linguistic Relativity

Klaus Thoden, M. A. (Research Scholar, January 1, 2011–June 30, 2014): DM2E and TextGrid

Georg Christoph Tholen, Dr., Professor für Medienwissenschaften an der Universität Basel (Visiting Scholar, October 1, 2009–January 31, 2010): Historical Research on Concepts of Image. Imagination, and Imaginary

Miao TIAN, Ph. D, Professor at the Chinese Academy of Sciences, Beijing (Visiting Scholar, February 1–August 15, 2009, funded by the „Topoi“ Research Group)

Margareta Tillberg, Dr., Associate Professor for History and Theory of Art and Design at the Linnaeus University (Visiting Scholar, April 21, 2006–December 31, 2011): State Design in the Soviet Union 1960s–1990s

Viktoria Tkaczyk, Dr. (Dilthey Fellowship Research Group Leader and Assistant Professor, Universiteit van Amsterdam, September 1, 2011–August 31, 2016, funded by the Volkswagenstiftung): The Making of Acoustics in 16th to 19th Century Europe

Magaly Tornay, Universität Zürich (Predoctoral Research Fellow, November 1, 2009–April 30, 2010, funded by the Schweizerischer Nationalfonds): History of Psychoactive Drugs: Psychoactive Drugs and Personality Concepts in Switzerland (1950–1990)

Barbara Tramelli, Warburg Institute, University of London (Predoctoral Research Fellow, October 1, 2011–September 30, 2014): Around Lomazzo: artists' education and appropriation of knowledge in sixteenth-century Milan

John Tresch, Ph. D., Associate Professor, University of Pennsylvania (Visiting Scholar, January 1–June 30, 2012): Poe's American Experiments

Stefan Trzeciok, FU-Berlin (Predoctoral Research Fellow, October 1, 2008–June 30, 2012): Knowledge transfer in the Renaissance: Thomas Alvarus, Natural Philosophy and the Artist's Faculty

Christina Tsouparopoulou, Ph. D. (Postdoctoral Research Fellow, December 1, 2008–March 31, 2011, funded by the Mellon Foundation): Establishment of a database for Ancient Near Eastern seals, sealings, and seal impressions for the CDLI

Aaron Tugendhaft, Ph. D., New York University (Postdoctoral Research Fellow, July 1–August 31, 2012): Gods on Clay: Ancient Near Eastern Scholarly Practices and the History of Religion

Irina Tupikova, Ph. D., Lecturer, Institute for Planetary Geodesy, TU Dresden (Research Scholar, September 15, 2008–May 14, 2011, Visiting Scholar, August 1–December 31, 2012): Episteme in Motion

Jorge Patricio Urzúa Contreras, PhD Student, TU Berlin; Computer Engineer (Research Scholar, March 1, 2010–June 30, 2014, funded by the McGill University, Montreal, Canada): Islamic Scientific Manuscripts Initiative

Luděk Vacín, Ph. D. (Postdoctoral Research Fellow, April 1, 2010–June 30, 2012): Bilinguals in Late Mesopotamian Scholarship

Sophia Vackimes, Ph. D. (Visiting Scholar, April 1–June 30, 2010): Passports: from Biometrics to Genetics

Mauro Sebastián Vallejo, Universidad de Buenos Aires (Predoctoral Research Fellow, March 1–May 31, 2010): “Relationship between Freud’s Ideas and the “Hereditarian” Medicine of the 19th Century”

Matteo Valleriani, Dr. (Research Scholar, since January 1, 2004): Technology Transfer in Antiquity, Aristotle’s Mechanics, Ancient Hydromechanics and Pneumatics, Early modern mechanics, Galileo Galilei, Shipbuilding, Pratolino Garden, Jesuits’ Hydraulics

Dora Vargha, Rutgers University (Predoctoral Research Fellow, January 1–June 30 and September 1–June 30, 2013, partly funded by the Mellon Foundation): Iron Curtain, Iron Lungs: Polio Epidemics in Cold War Hungary 1952–1963

Ricardo Ventura Santos, Ph. D., Senior Researcher, Escola Nacional de Saúde Pública, Fundação Oswaldo Cruz, Rio de Janeiro, Brasil (Visiting Scholar, September 3–September 28, 2012): Race, genetics/genomics and the reconfiguration of Brazilian national identity (1960–2010)

Han Vermeulen, Dr. (Visiting Scholar, October 1, 2011–June 30, 2012): Anthropology and Ethnology in the German and Russian Enlightenment: Transnational Relations and Transfer of Knowledge during the eighteenth and early nineteenth century

Fernando Vidal, PD Dr. (Research Scholar September 1, 2000–September 30, 2012): The Cerebral Subject: Brain, Self and Body in History and Contemporary Culture; Endangerment and Its Consequences

Ana Carolina Vimieiro Gomes, Department of History — Universidade Federal de Minas Gerais, Brazil (Postdoctoral Research Fellow, January 3–February 29, 2012)

Paolo Visigalli, Wolfson College, Cambridge, United Kingdom (Predoctoral Research Fellow, July 1–August 31, 2012): How Ritual Use Affects the Codification of the Canon: The Conception of Mantradevat as a Classificatory System of the Vedas

Samuel Vitali, Dr. (Research Scholar, March 1–June 30, 2010)

George N. Vlahakis, Ph.D., Lecturer, Hellenic Open University and Fellow Researcher, National Hellenic Research Foundation (Project “Hephaestus”) (Visiting Scholar, December 1, 2010–April 30, 2011): The German Influence on the Formation of the Character of the Physical Sciences in the Modern Greek State (1830–1950)

Klaus Vogel, Dr. phil., Historian of Science, Merchant Marine Captain (Visiting Scholar, March 9, 2012–February 28, 2013): History of Cosmography/Geography, History of Natural Philosophy, European Expansion and Cultural Contact

Annette Vogt, Dr. (Research Scholar, since September 15, 1994): History of Mathematics and Science in the 19th and 20th Centuries, esp. in Germany; Woman in Science

Ronny Vollandt, Ph.D. Cantab (Postdoctoral Research Fellow, July 1–August 31, 2012): A Medieval Coptic Hebraism? Coptic Adaptations of Saadia Gaon’s Judaeo-Arabic Translation of the Torah, Their Transmission and Textual Practice

Axel Volmar, (Visiting Scholar, November 22, 2010–January 31, 2011)

Kathleen Vongsathorn, Ph.D. (Postdoctoral Research Fellow, September 1, 2012–August 31, 2014): Women and the Spread of Biomedical Knowledge in Colonial Uganda

Renate Wahsner, Dr., Professorin für Wissenschaftsgeschichte (Research Scholar, October 1, 1995–March 31, 2003, associated): History of Philosophy in Connection with History of Science; Epistemological Fundamentals and Problems of Physics; German Idealism; Classical Natural Philosophy.

Silvia Waisse Priven, Ph.D. (Visiting Scholar, July 1–July 21, 2010): Signs and Medical Ways of Knowledge in the 18th Century

André Wakefield, Ph.D., Associate Professor of History, Pitzer College, Claremont, USA (Visiting Scholar, June 1, 2012–June 30, 2013, funded by the Humboldt Foundation): Leibniz in the Harz: History, Invention, and the Archives of Nature

Oriana Walker, Harvard University, Cambridge, USA (Predoctoral Research Fellow, September 1, 2012–August 31, 2013): A Cultural History of Breathing

Daniel J. Walther, Ph. D., Gerald R. Kleinfeld Distinguished Professor in German History, Professor of History, Chair of History Department, Wartburg College, USA (Postdoctoral Research Fellow, September 1–November 30, 2011, funded by the Fulbright Program): The Medicalization of German Colonialism: STDs, Colonial Physicians, and Indigenous Agency, 1884–1914

Harriet WANG Cong, The Institute of Policy and Management, Chinese Academy of Sciences, Beijing, China (Predoctoral Research Fellow, September 1, 2011–August 31, 2012): Sino-German Comparative Study

Daniel Warren, Ph. D., Associate Professor of Philosophy at the University of California at Berkeley (Visiting Scholar, September 9, 2010–June 30, 2011)

Eric Watkins, Ph.D., Associate Professor of Philosophy, University of California, San Diego, U.S.A. (Visiting Scholar, June 28–July 31, 2010 and August 5–September 5, 2010): Immanuel Kant: Natural Philosophy

Cecelia Watson, Ph. D., Conceptual & Historical Studies of Science University of Chicago (Pre- and Postdoctoral Research Fellow 2010/12, Research Scholar August 1, 2012–January 31, 2013): John La Farge, William James, and the Search for Truth in Art, Science, and Philosophy; The Anthropocene Project

Milena Wazeck, Dr. (Research Scholar, February 15, 2004–December 31, 2010): Opposition to the Theory of Relativity in the 1920s: History of Science Policy

Hilde de Weerdt, Ph. D., Harvard University, University Lecturer in Chinese History, University of Oxford, Fellow Pembroke College (Visiting Scholar, July 15–October 15, 2010, April 15–July 15, 2011): Tracking Citation Patterns and Knowledge Diffusion in Notebooks (biji)

Mai Wegener, Dr. (Visiting Scholar, June 1–August 31, 2010): Three Undiscovered Epistemologists: Paul Valéry, Jacques Lacan and Kurt Goldstein

Joanna Weinberg, Ph. D., Reader in Hebrew and Jewish Studies, University of Oxford (Visiting Scholar, July 6–August 17, 2012): Johann Buxtorf and his Copybook: Testimony to a Renaissance Hebraist's Frenzied Study of Hebrew Literature

Peter Weingart, Ph. D., Professor of Sociology, University of Bielefeld (Visiting Scholar, January 1–June 30, 2011): Wissenschaft in Massendemokratien

Helge Wendt, Dr. (Lorenz Krüger Postdoctoral Research Fellow, May 1, 2011–April 30, 2013)

Anja Werner, Ph. D. (Postdoctoral Research Fellow, April 1, 2012–March 31, 2013)

Klaus Werner, PhD, Bibliotheca Hertziana, Rome, Italy (Research Scholar, February 1–December 31, 2012): Art and Knowledge in Premodern Europe

Christina Wessely, Ph. D. (Postdoctoral Research Fellow, March 1, 2009–May 9, 2010): Science, Pseudoscience and the Limits of Cosmological Knowledge around 1900

Andrea Westermann, Ph. D. (Postdoctoral Research Fellow, September 1–December 31, 2010): Overcoming the Division of Labor in Global Tectonics: Eduard Suess' *The Face of the Earth*

Matthijs Weststeijn, Ph. D. (Postdoctoral Research Fellow, September 1–November 30, 2012): China in the Studio — Painting Porcelain in the Seventeenth-Century Netherlands

Steve Wharton, Ph. D., Lecturer/Tutor University of Sussex Associate Professor, American Institute for Foreign Studies, Richmond International University, Kensington, London (Visiting Scholar, October 1–November 30, 2012): The History of Art and the Transmission of Knowledge in The Three Books of the Art of the Potter

Kelly J. Whitmer, Ph. D. (Postdoctoral Research Fellow, June 1, 2008–July 31, 2010): Models and the Middle Way: Performing Philanthropy in the Early Enlightenment

Alexandra Widmer, Ph. D. (Postdoctoral Research Fellow/Research Scholar, September 1, 2009–April 30, 2013): Scandalous Subjects: Island Lives and Demographic Anxieties from Race to Development in Melanesia

Felix Wiedemann, Dr. (Postdoctoral Research Fellow, May 14–June 15, 2012, funded by the Excellence Cluster Topoi): Migration Narratives in Ancient Near Eastern Studies

Robert-Jan Wille, MA and MSC, Faculty of Arts, Radboud University Nijmegen (Predoctoral Research Fellow, October 14–November 14, 2012): The Interrelation between Government Support of Biology, Academic Biological Thinking, and Colonial Governance of Europe

Josef Willenborg, Dr. (Research Scholar, September 1, 2008–December 31, 2012): Max Planck Digital Library

Christine Winter, Ph. D. (Visiting Scholar, June 10–August 15, 2012): Race mixing and Aryan-Related Races from the Asia-Pacific: Continuities, Discontinuities and Connections

Dirk Wintergrün, Dipl. Phys. (Research Scholar, since January 1, 2000): Information Technology Group (Head)

M. Norton Wise, Ph. D., Ph. D., Professor of History at the University of California, Los Angeles (Visiting Scholar, September 1–September 30, 2010); Laboratory Science in Burgeois Berlin

Per Wisselgren, Ph. D., Associate Professor of Sociology, Umeå University (Postdoctoral Research Fellow, September 1–October 31, 2012, funded by the Umeå University, Sweden): The Social Scientific Gaze: The Social Question and the Rise of Academic Social Science in Sweden, 1830–1920

Barbara Wittmann, Dr. (Research Scholar, November 1, 2003–June 24, 2010): Meaningful Scribbles. Children's Drawings as Psychological Instruments, 1880–1950

Herta Wolf, Dr., Professorin für Geschichte und Theorie der Fotografie am Kunsthistorischen Institut der Universität zu Köln (Visiting Scholar, April 1–June 30, 2010)

Gereon Wolters, (Visiting Scholar, July 1–September 30, 2011): Annotierte Edition von: Die Mechanik in ihrer Entwicklung historisch-kritisch dargestellt von Ernst Mach

Alexander Wragge-Morley, University of Cambridge (Predoctoral Research Fellow, February 1–July 31, 2011): 'Design' and Representation in English Natural Philosophy and Theology, 1650–1720

Yvonne Wübben, J.-Prof. Dr. med. Dr. phil. Universität Bochum (Visiting Scholar, September 1–October 31, 2012): Writing the Textbook Case: Epistemic Genre and Practices in Psychiatry (1870–1920)

Monika Wulz, Dr. phil. (Postdoctoral Research Fellow, October 1, 2008–December 31, 2010, February 1–February 28, 2011, September 1–October 31, 2011): Social Concepts and Methods in Epistemology about 1910–1950: Edgar Zilsel's Socio-historical Approach to Epistemology and his Concept of Science as an „Infinite Process“

Falk Wunderlich, Dr., Johannes Gutenberg-Universität, Mainz (Visiting Scholar, September 1, 2011–October 31, 2014, funded by the Deutsche Forschungsgemeinschaft): Thinking matter versus physical influx. Core debates in German philosophy of mind, ca. 1750–1800

Guoqing Yang, History Museum of Ming City Wall Nanjing (Visiting Scholar, July 15–September 15, 2011): Techniques of Building City Walls in the Middle Ages: A Historical Comparison between Germany and China

Sebastian Zacharias, (Predoctoral Research Fellow, September 1, 2009–December 31, 2012, funded by the Stiftung der Deutschen Wirtschaft): Continuity and Discontinuity during the Darwinian Revolution. An analysis of public and scientific reception and impact of Darwin's Origin based on a novel framework of scientific theories

Nasser Zakariya, Ph. D. (Postdoctoral Research Fellow, March 1–August 31, 2010): Narratives of Quest and the Scientific Study of Origins

Gábor Áron Zemplén, Ph. D. (Visiting Scholar, October 1, 2009–January 31, 2010): Scientific Debates Around the Modificationist Theories of Colour

Hansjakob Ziemer, Dr. (Research Scholar, since January 1, 2008): Translating Everyday Experience into Social Knowledge: Central European Feuilleton Culture around 1900

Anne Ziemke, Max-Planck-Institut für demografische Forschung, Rostock (Predoctoral Research Fellow, July 1, 2008–October 31, 2010): Aging Research in 19th Century Biology

Rafaela Teixeira Zorzanelli, Ph. D., Institute for Social Medicine, State University of Rio de Janeiro, Rio de Janeiro, Brazil (Visiting Scholar, July 1–July 31, 2010): Public Understanding of Functional Syndromes in Brazil: Attention Deficit Disorder, Chronic Fatigue Syndrome, and Fibromyalgia

Collaborations and Other External Activities

Memberships

The Institute is member of the Agricola-Gesellschaft, the Gesellschaft für Wissenschaftsgeschichte and the Deutsche Gesellschaft für Geschichte der Medizin, Naturwissenschaft und Technik.

Professorships

Lorraine Daston is Professor at the University of Chicago and Honorarprofessorin at the Humboldt-Universität zu Berlin,

Sven Dupré is Professor at the Freie Universität Berlin,

Dieter Hoffmann is außerplanmäßiger Professor at the Humboldt-Universität zu Berlin,

Ursula Klein is außerplanmäßige Professorin at the Universität Konstanz,

Wolfgang Lefèvre is außerplanmäßiger Professor at the Freie Universität Berlin,

Veronika Lipphardt is Professorin at the Freie Universität Berlin,

Jürgen Renn is Adjunct Professor at the Boston University and Honorarprofessor at the Humboldt-Universität zu Berlin and the Freie Universität Berlin,

Hans-Jörg Rheinberger is Honorarprofessor at the Technische Universität Berlin.

Cooperation Partners

American Academy in Rome (Italy)

Archive for the History of Quantum Physics (USA)

Berliner Antike Kolleg (Germany)

Berlin-Brandenburg Academy of Sciences and Humanities (Germany)

Berlin Graduate School for Ancient Sciences (Germany)

Bibliotheca Hertziana, Max Planck Institute for Art History (Italy)

Centre Alexandre Koyré (France)

Collaborative Research Centre 644 “Transformations of Antiquity” (Germany)

Collaborative Research Centre 980 “Episteme in Motion” (Germany)

Einstein Papers Project (USA)

Comenius-Garten Berlin (Germany)

Centre Marc Bloch (Germany)

Chinese Academy of Sciences

Excellenc Cluster TOPOI (Germany)

Forum Transregionale Studien (Germany)

Foundation Lindau Nobelprizewinners Meetings at Lake Constance (Germany)

Freie Universität Berlin (Germany)

Friedrich-Schiller-Universität Jena (Germany)

Fritz Haber Institute of the Max Planck Society (Germany)

German Archaeological Institute (Germany)
Ghent University (Belgium)
Hebrew University (Israel)
Haus der Kulturen der Welt Berlin (Germany)
Humboldt-Universität zu Berlin (Germany)
Institut National des Sourds-Muets (France)
Kunsthistorisches Institut in Florenz (Italy)
Laboratoire SPHERE (CNRS, France)
London School of Economics (UK)
Max Planck Institute for Social Anthropology (Germany)
McGill University (Canada)
Mongolian Academy of the Sciences
Museum Kunstpalast, Düsseldorf (Germany)
National University of Ireland
Rubenianum (Belgium)
Scuola Normale Superiore di Pisa (Italy)
Stiftung Preußischer Kulturbesitz (Germany)
Social Sciences and Humanities Research Council (Canada)
Technische Universität Berlin (Germany)
Universidade do Estado do Rio de Janeiro (Brazil)
University of Bern (Switzerland)
University of Amsterdam (The Netherlands)
University of California at Los Angeles (USA)
University of Chicago (USA)
University of Chicago Center Paris (France)
University of Haifa (Israel)
University of Illinois (USA)
University of Lucerne (Switzerland)
University of Rostock (Germany)
University of Wisconsin–Madison (USA)
Wissenschaftskolleg zu Berlin (Germany)

Hosted Scholars

From 2010–2012, the institutions listed below funded 104 scholars.
The average duration of their stay was 7.5 months.

Alexander von Humboldt Foundation (Germany)
Andrew W. Mellon Foundation (USA)
Bank of Sweden, Tercentenary Foundation
Bauhaus-Universität Weimar (Germany)
Brazilian Federal Agency for Support and Evaluation of Postgraduate Education
(CAPES)
Brazilian Research Council
Brock University (Canada)

Bundesministerium für Bildung und Forschung (Germany)
 CNRS (France)
 Collegium Helveticum (Switzerland)
 Deutsche Forschungsgemeinschaft (Germany)
 Economic and Social Research Council (UK)
 European Union
 Excellence Cluster Topoi (Germany)
 Fondation Maison des Sciences de l'Homme (France)
 Freie Universität Berlin (Germany)
 Fritz-Haber-Institut der Max-Planck-Gesellschaft (Germany)
 Fritz-Thyssen-Stiftung (Germany)
 Fulbright Program (USA)
 German Academic Exchange Service (DAAD)
 German Israeli Foundation
 Hans Böckler Stiftung (Germany)
 Harvard University (USA)
 Institut universitaire de France
 Martin-Luther-Universität Halle-Wittenberg (Germany)
 Max Delbrück Center for Molecular Medicine (Germany)
 McGill University (Canada)
 Minerva Foundation (Germany)
 National Hellenic Research Foundation (Greece)
 Netherlands Foundation for Scientific Research
 New Europe College (Romania)
 New York University (USA)
 Ruhr-Universität Bochum (Germany)
 Spanish National Research Council
 Stiftung der Deutschen Wirtschaft (Germany)
 Studienstiftung des Deutschen Volkes (Germany)
 Swiss National Science Foundation
 Umeå University (Sweden)
 Union College (USA)
 University of California at Berkeley (USA)
 University of Lucerne (Switzerland)
 University of Michigan (USA)
 University of Warwick (UK)
 Volkswagenstiftung (Germany)

Teaching Activities

Spring, Summer 2010

Susanne Bauer (with Estrid Sørensen and Jörg Potthast): Einführung in die Science and Technology Studies (STS) II: Die empirische Erforschung epistemischer Kulturen (Seminar, Humboldt Universität zu Berlin)

Mirjam Brusius: William Henry Fox Talbot. Photographie, Wissenschaft und Universalgelehrtentum im 19. Jahrhundert (Seminar, Humboldt Universität zu Berlin)

Lorraine Daston: States of Nature: Animals in Religion and Science (Seminar, University of Chicago)

Christine von Oertzen in Cooperation with the Museum für Photographie, Braunschweig, and the Stadtarchiv Braunschweig: Bilder als historische Quelle (Proseminar, Technische Universität Braunschweig)

Jürgen Renn: Il Rinascimento della Meccanica (Summer school lecture, 13th annual Seminar on Giordano Bruno organized by Centro Int. di Studi Bruniani 'Giobvanni Aquilecchia' and the Istituto per gli Studi Filosofici, Naplea at Warburg Institute)

Viktoria Tkaczyk: Forschungsobjekte in Aktion (Summer school course, eikones NFS Bildkritik, Basel)

Matteo Valleriani: Galileo Galilei: die frühneuzeitliche Wissenschaft und ihr Kontext (Proseminar, Technische Universität Berlin)

Annette Vogt (with Peter Th. Walther): Akademische Emigration und Remigration 1933–1960/61 (Proseminar, Humboldt Universität zu Berlin)

Annette Vogt (with Wolfgang Härdle and Andrija Mihoci): What is statistics? — From the Historical Perspective (Seminar, Humboldt Universität zu Berlin)

Winter 2010/11

Christian Joas (with Paul Fumagalli): Physik-Kolloquium (Freie Universität Berlin)

Ursula Klein: Wissenschaftsphilosophie im historischen Kontext (Kompaktseminar, Universität Konstanz)

Veronika Lipphardt: Theorie, Methoden und Geschichte der Geschichtswissenschaft (Seminar, Freie Universität Berlin)

Christine von Oertzen: Arbeit, Familie und Geschlecht im 20. Jahrhundert (Hauptseminar, Technische Universität Braunschweig)

Arne Schirrmacher: Politik der Exzellenz. Die naturwissenschaftlichen Nobelpreise und ihre politische Rolle im 20. Jahrhundert (Seminar, Humboldt Universität zu Berlin)

Viktoria Tkaczyk: Studying the year 1789 — Introduction into Theatre Historiography (Undergraduate seminar, Freie Universität Berlin)

Matteo Valleriani: Das Experiment: eine Reise in den wissenschaftlichen Salon Robert Boyles (Proseminar, Technische Universität Berlin)

Annette Vogt (with Peter Th. Walther): Rundfunk als historische Quelle? Zeitzeugen berichten im Rundfunk ab 8. Mai 1945 (Proseminar, Humboldt Universität zu Berlin)

Spring, Summer 2011

Susanne Bauer (with Jörg Niewöhner and Martina Schlünder): Ethnographie in Bewegung. Science and Technology Studies (STS) II. (Seminar, Humboldt Universität zu Berlin)

Etienne Benson: Tracking Nature (Seminar, University of Chicago)

Lorraine Daston: History's Histories (Seminar, University of Chicago)

Nils Güttler: Mit Karten denken – Karten als wissenschaftliche Praxis im 19. Jahrhundert (Seminar, Universität der Künste Berlin)

Ursula Klein: Die französische Tradition der historischen Epistemologie und Wissenschaftsphilosophie (Kompaktseminar, Universität Konstanz)

Christine von Oertzen: Volkszählungen und Massendaten im 19. und 20. Jahrhundert (Hauptseminar, Technische Universität Braunschweig)

Jürgen Renn: Verso una teoria epistemologica della meccanica (Summer school lecture, Biblioteca Leonardo di Vinci, Italy)

Arne Schirrmacher: “Lesprit n’a point de sexe” Geschlechterdiskurse in der Wissenschaft vom 17. bis 21. Jahrhundert (Seminar, Humboldt Universität zu Berlin)

Matteo Valleriani: Technologie und Geometrie: die frühneuzeitliche Revolution der Kriegskunst (Proseminar, Technische Universität Berlin)

Annette Vogt (with Wolfgang Härdle): What is statistics? — Aspects of its History (Seminar, Humboldt Universität zu Berlin)

April 2011–June 2012

Viktoria Tkaczyk (with Pierre Cassou-Nogues and Koen Vermeir): Machines et Imaginations (Séminaire, Laboratoire SPHERE (CNRS), Paris, France)

Fall 2011, Winter 2011/12

Susanne Bauer: Atomic Challenges. Biomedicine and Nuclear Science during the Cold War (Seminar, Indiana University, Bloomington)

Sven Dupré: Optics and Perspective in Early Modern Art (Seminar, Freie Universität Berlin)

Ursula Klein: Philosophie der “angewandten Wissenschaften” (Kompaktseminar, Universität Konstanz)

Christine von Oertzen (in cooperation with the Topography of Terror Documentation Center, Berlin): Der Verfolgungs- und Terrorapparat der NS-Sicherheitsorgane (Hauptseminar, Technische Universität Braunschweig)

Jürgen Renn: Einstein and Relativity (Winterseminar lecture, 47th Winterseminar, Biophysical Chemistry, Molecular Biology and Cybernetics of Cell Functions, Klosters, Switzerland)

Viktoria Tkaczyk: The Past in the Ear. The Art and Media History of the Acoustic Memory (Graduate course, University of Amsterdam)

Spring, Summer 2012

- Lorraine Daston*: Naturalism as a Way of Life (Seminar, University of Chicago)
Sven Dupré: Early Modern Art and Alchemy: Between Theory and Craft (Seminar, Freie Universität Berlin)
Sven Dupré: Leonardo da Vinci between art and science (NEH Summer Institute, Kunsthistorisches Institut in Florenz)
Veronika Lipphardt: Rassenforschung in der Weimarer Republik (Seminar, Freie Universität Berlin)
Annette Vogt (with Weining Wang): What is statistics? — History of Statistic from the 18th until the 20th century (Seminar, Humboldt Universität zu Berlin)

Fall 2012, Winter 2012/13

- Etienne Benson*: Environment and Society (Seminar, New York University Berlin)
Sven Dupré: The Material Culture of Knowledge: Objects of Art and Science in the Early Modern History of Collecting (Seminar, Freie Universität Berlin)
Ursula Klein: Philosophie der Chemie (Kompaktseminar, Universität Konstanz)
Christoph Lehner: Klassiker und Revolutionäre: Probleme der modernen Physik in Originaltexten (Seminar, Freie Universität Berlin)
Veronika Lipphardt: Theorie, Methoden und Geschichte der Geschichtswissenschaft (Seminar, Freie Universität Berlin)
Veronika Lipphardt (with Robert Meunier): Wissenschaftsgeschichte, Wissenschaftstheorie, historische Epistemologie. Zur Einführung (Seminar, Freie Universität Berlin)
Christine von Oertzen (in cooperation with the Topography of Terror Documentation Center, Berlin): Der Verfolgungs- und Terrorapparat der NS-Sicherheitsorgane (Hauptseminar, Technische Universität Braunschweig)
Hans-Jörg Rheinberger: 1. Objekt/Subjekt: Sehen-Verstehen-Begehren 2. Ideal und Phantasma: der Körper als ästhetisches und epistemisches Objekt (Seminar, Katholische Universität Eichstätt-Ingolstadt)
Matthias Schemmel (with Klaus Vogel and Günther Görz): Karten, Globen, Kosmographien und der Weltbildwandel um 1500 (Seminar, Technische Universität Berlin)

Conferences, Workshops, and Colloquia

Conferences

January 8–9, 2010: Documenting the World

January 21–23, 2010: Challenging Objects

January 27, 2010: Ways of Voyaging through the Human Body. A Multimedia Survey

January 29–30, 2010: The Ur Science

March 15–16, 2010: The Strangelovean Science Or: Rationality versus Reason

March 18–20, 2010: Sciences of Communication in the Twentieth Century

April 2–3, 2010: The Human Subject in the Human Sciences

May 6–8, 2010: 20th Century Science Communication in Europe: The Political and Cultural Context

May 27–September 29, 2010: Body Montage: Cultures of Corporeal Dis/Assembling, 1900–1933

June 9–12, 2010: Reading Against the Grain: National Historiographies in the Human Sciences As Seen from an Outsider Perspective

June 17, 2010: Paperwork: Writing (in) Books, 1650–1850

June 18–19, 2010: Gender Studies of Science: Using and Producing Science Beyond the Academy

June 23–24, 2010: Freud's Rome: Phobia and Phantasy

June 24–26, 2010: Scientific Objects and their Materiality in the History of Chemistry

June 28–July 2, 2010: HQ-3 Third International Conference on the History of Quantum Physics

July 2, 2010: Scholars' Forum: ZwischenRäume 17— Fokus: Unterbrechungen

July 10, 2010: 5th Scholar's Forum: Literature & History of Science

July 15–18, 2010: Conceptual Change in Biological Science: Evolutionary Developmental Biology, 1981–2011

August 10–12, 2010: Historical Roots of Quantum Gravity Research

October 4, 2010: Objekt-Salon: Die Ordnung der Dinge

October 5, 2010: Scientific Objects in Dialogue

October 7–9, 2010: Membranes, Surfaces and Boundaries: Interstices in the History of Science, Technology and Culture

October 15–16, 2010: Machines of Memory: Archival Technologies and the Genealogy of Datapower (17th — 20th Centuries)

October 22–23, 2010: Artisanal-Scientific Experts in Eighteenth-century France and Germany

October 24–25, 2010: Internationaler Arbeitskreis zu Hegels Naturphilosophie

November 8–10, 2010: Crossing Boundaries: Multilingualism, Lingua Franca and Lingua Sacra

November 17, 2010: Arnold Schönberg, Das Buch der hängenden Gärten

December 9–11, 2010: History and Epistemology: From Bachelard and Canguilhem to Today's History of Science

December 10–11, 2010: Conflicting Values of Inquiry: Ideologies of Epistemology in Early Modern Europe

- December 15–16, 2010:** Tacit Knowing: Manual Knowledge in Art, Science and Technology
- December 17–18, 2010:** Historical Systems of Innovation. The Culture of Silk in the Early Modern World (14th–18th Century)
- January 13–15, 2011:** Immortal Bodies
- January 24, 2011:** Festkolloquium für Hans-Jörg Rheinberger
- January 28–29, 2011:** Verwissenschaftlichung der Antike: Transformationen zwischen Idealisierung und Distanzierung
- February 16, 2011:** 1. Berliner Kolloquium für Digital Humanities — Berlin 02/10
- March 18–19, 2011:** Transliteration and Transfiguration of Cultural Traditions: Archaeology, Medical Knowledge, Art, and Science
- March 23, 2011:** 2nd Berlin Colloquium for Digital Humanities — Berlin 03/11
- March 25–26, 2011:** The New Histories of Rice
- May 2–3, 2011:** Knowledge to Die For
- May 12–14, 2011:** Ritual and Technology in East Asia
- June 27–30, 2011:** Roots of Quantum Gravity
- July 7–9, 2011:** Beyond the Academy: Gendered Histories of Science
- July 9, 2011:** 6th Scholars' Forum Literature and History of Science
- September 29, 2011:** Wissenschaftliches Arbeiten mit digitalen Quellen: Herausforderungen für die DDB
- October 14–15, 2011:** Endangerment and its Consequences
- November 24–26, 2011:** Data — Difference — Diversity
- December 1–3, 2011:** Neuro-Reality Check: Scrutinizing the “Neuro-Turn” in the Humanities and Natural Sciences
- February 9–10, 2012:** Art and Alchemy
- March 12–14, 2012:** Thinking With Tables
- March 16–17, 2012:** Regulating Research
- March 19, 2012:** Beyond Galileo’s “O”
- March 27, 2012:** Anthropologie und Ethnologie im 18. und 19. Jahrhundert
- April 19, 2012:** Population Diversities Past and Present: Stakes, Genealogies, Taboos
- June 8, 2012:** The Analytical Turn of the Sciences
- June 8–9, 2012:** The Measurement of Values
- June 11–13, 2012:** Colonial Subjects of Health and Difference: Races, Populations, Diversities
- June 28–30, 2012:** Making Human Heredity: Populations and Public Health in the Postwar Era
- July 7, 2012:** 7th Scholars' Forum Literature and History of Science
- July 17–20, 2012:** Endangerment and its Consequences (II)
- August 27–29, 2012:** Space, Geometry and the Imagination. From Antiquity to the Modern Age
- September 21–22, 2012:** Instructions, Questions and Directions
- October 12–13, 2012:** Perspective as Practice
- October 15–17, 2012:** Minerva Gentner Symposium 2012: The Study of Jewish Biological Difference After 1945
- October 17–20, 2012:** Towards a history of the history of science: 50 years since “Structure”

October 23, 2012: Die Max-Planck-Gesellschaft zwischen Wissenschafts- und Zeitgeschichte

October 26–27, 2012: Globalization of Knowledge in the Mediterranean World of Post-Antiquity

October 30, 2012: Constructing Norms and Disputing the Boundaries of Expertise: Interrogating the Legacy of Georges Canguilhem and Michel Foucault

November 29–30, 2012: Reading the Inventory: The Collection of the Portuguese Merchant-Banker Emmanuel Ximenes in Early Seventeenth-Century Antwerp

November 30–December 1, 2012: Celebrating the 50th Anniversary of Thomas Kuhn's *The Structure of Scientific Revolutions*

December 6, 2012: Gedenkkolloquium für Peter Damerow

December 10–11, 2012: Deaf World/Hearing World: Spaces, Techniques, and Things in Culture and History

December 14, 2012: Berlin Doctoral Forum for the History of Science

The Institute's Colloquia



January 13, 2010: *Herta Wolf* (Universität Duisburg-Essen): Snow-Crystals, for instance. Aspects of the chemical and optical differentiation of the photographic recording process from 1839 through 1900.

February 24, 2010: *Peter Schöttler* (CNRS Paris): From Comte to Carnap. Fresh Perspectives on the Vienna Circle in France

March 24, 2010: *Thomas Schlich* (McGill University, Montreal): The “Ballet of the Crutches”: Photography, Body Function and Rationalized Fracture Care (WWI and 1920s Vienna)

May 5, 2010: *Veronika Lipphardt and Susanne Bauer*: From Field Surveys to Biobanks. A History of Knowledge about Human Biological Diversity

June 9, 2010: *Nick Wilding*: Euripus: on the limits and instabilities of Early Modern knowledge

June 23, 2010: *Staffan Müller-Wille* (University of Exeter): Annotating the System of Nature: Carl Linnaeus and the Uses of Writing Technologies

July 7, 2010: *Carlo Ginzburg* (Scuola Normale Superiore di Pisa): Nature vs. Culture. A Boundless Topic and a Case Study

October 27, 2010: *Mary Jo Nye* (Corvallis, Oregon): The Economic Foundations of Michael Polanyi's “Republic of Science”

November 24, 2010: *Reimar Lüst* (Hamburg): The Driving Force of the Max Planck Society: The Harnack Principle and the Scientific Coworkers. Reminiscences of a former President

December 15, 2010: *Hubert Laitko* (Berlin): Das Harnack-Prinzip als institutionelles Markenzeichen. Faktisches und Symbolisches

January 19, 2011: *Helmuth Trischler* (München): Harnacks “Großbetrieb der Wissenschaft” in der Kaiser-Wilhelm-/ Max-Planck-Gesellschaft

February 16, 2011: *Ariane Leendertz* (München): Die Politik der Entpolitisierung: Die Max-Planck-Gesellschaft und die Sozialwissenschaften in Starnberg und Köln (1967–1985)

March 23, 2011: *Thomas Adam* (Arlington, Texas): Paying the Piper: Approaches to and Practices of the Private Funding for the Sciences in Germany from the 1870s to the 1950s

April 13, 2011: *Manfred Rasch* (Duisburg): Patente, Lizenzen, Studien- und Verwertungsgesellschaften. Zur kommerziellen Nutzung von Forschungsergebnissen aus Kaiser-Wilhelm-/ Max-Planck-Instituten

May 11, 2011: *Carola Sachse* (Wien): “Grundlagenforschung”. Zum Wandel des Selbstbildes der Kaiser-Wilhelm-/Max-Planck-Gesellschaft in den ersten Jahren des Kalten Krieges

June 15, 2011: *Mitchell Ash* (Wien): Ressource Exchanges: The Kaiser Wilhelm / Max Planck Society and Regime Changes in Germany — 1918/1933/1945/1990

July 13, 2011: *Gerhard Wolf* (Florenz): Geisteswissenschaftliche Forschung in der Kaiser.Wilhelm/Max-Planck-Gesellschaft

September 28, 2011: *Julia Kursell*: Historical Epistemology of Hearing, 1850–2000

October 19, 2011: Ursula Klein: The Prussian Mining Official Alexander von Humboldt

November 23, 2011: Viktoria Tkaczyk: Spoken Word Theatre and the Architects of Sound, 1800/1900

December 14, 2011: *Sabine Arnaud*: Writing Deafness in the Eighteenth and Nineteenth Century

January 25, 2012: *Fernando Vidal*: Genealogy and Topography of “Endangerment”

February 22, 2012: *Sven Dupré*: Knowledge in the Artist’s Studio

March 21, 2012: *Martha Fleming*: Early Modern Display and Taxonomy

April 25, 2012: *Vincenzo De Risi*: Proving the Parallel Postulate in the Early Modern Age: Philosophy and Mathematics

May 23, 2012: *Matthias Schemmel*: The Place of Mohist Science in a Long-Term History of Knowledge

June 20, 2012: Suparna Choudhury and Felicity Callard: Situating the Brain Between the Natural Sciences and Humanities

September 12, 2012: Henrique Leitão (University of Lisbon): The Ship as “New World”: Long-distance Oceanic Voyages and the Practice of Science (15th to 18th cent.)

November 27, 2012: *Dirk Wintergrün*: Towards an Infrastructure for Digital Humanities at the MPIWG: From ECHO to the Digital ScrapBook

November 28, 2012: *Renée Raphael* (University of California, Irvine): Evaluating Galileo’s Discorsi: Theoretical and Practical Knowledge in the Scholarly Practices of 17th-century Readers

December 5, 2012: *Ursula Klein*: Experts in the Royal Prussian Porcelain Manufactory

December 19, 2012: *Urs Schoepflin*: Linking Scholars. Bringing your Research on the Web — Copyrights, Publication Agreements, and Other Issues

Scholars' Forum

In cooperation with partner institutions, the Max Planck Institute for the History of Science organizes scholars' forums for doctoral candidates and postdoctoral fellows: Berliner DoktorandInnenforum für Wissenschaftsgeschichte: December 14, 2012; Studententag Literatur und Wissenschaftsgeschichte: July 12, 2010; July 9, 2011, and July 7, 2012; ZwischenRäume: July 2, 2010

Academic Achievements and Scientific Awards

Completed Dissertations

Christopher Plumb (2010), *Stefanie Gänger* (2011), *Vesa Arponen*, *Sven Bergmann*, *Nils Güttler*, *Stefanie Klamm*, *Fabian Krämer*, *Harun Küçük*, *Ulla Kypta*, *Sophie Ledebur-Wicheln*, *William Lockhart*, *Robert Meunier* (2012)

Appointments

Daniel Andersson (Postdoctoral Research Fellow September 1, 2007–August 31, 2010) was appointed as Research Fellow at the University of Oxford, Wolfson College, UK.

Elisa Andretta (Postdoctoral Research Fellow September 1, 2010–June 30, 2011) was appointed as Research Fellow at the Institut d'histoire de la médecine et de la santé, Geneva, Switzerland.

Monica Aufrecht (Predoctoral Research Fellow March 1–July 31, 2010) was appointed as Assistant Professor at the University of Washington, Seattle, USA.

Safia Azzouni (Visiting Scholar October 1, 2008–September 30, 2011) was appointed as Wissenschaftliche Mitarbeiterin at the Humboldt-Universität zu Berlin, Germany.

Stefan Bargheer (Postdoctoral Research Fellow December 1, 2010–August 31, 2012) was appointed as Assistant Professor at the University of California, Los Angeles, USA.

Susanne Bauer (Research Scholar September 1, 2009–December 31, 2011) was appointed as Juniorprofessorin at the Goethe-Universität Frankfurt am Main, Germany.

- Delphine Bellis* (Postdoctoral Research Fellow July 1–August 31, 2011) was appointed as Postdoctoral Researcher at Ghent University, Belgium.
- Etienne Benson* (Research Scholar September 1, 2010–August 31, 2013) was appointed as Assistant Professor at the University of Pennsylvania, USA.
- Sven Bergmann* (Predoctoral Research Fellow September 1–December 31, 2011) was appointed as Wissenschaftlicher Mitarbeiter at the DFG-Forschergruppe “Kulturen des Wahnsinns”, Germany.
- Joshua Berson* (Postdoctoral Research Fellow September 1, 2010–September 30, 2012) was appointed as Carson Fellow at the Ludwig-Maximilians-Universität München, Germany.
- Christina Brandt* (Research Scholar June 1, 2003–January 31, 2011) was appointed as Professor at the Ruhr-Universität Bochum, Germany.
- Grégoire Chamayou* (Research Scholar September 1, 2009–October 31, 2010) was appointed as Chargé de Recherche de Philosophie (CNRS) at the Institut d’Histoire de la Pensée Classique, Paris, France.
- Suparna Choudhury* (Research Scholar September 1, 2008–August 31, 2012) was appointed as Assistant Professor at the McGill University, Canada.
- Didier Debaise* (Postdoctoral Research Fellow October 1, 2008–September 30, 2010) was appointed as Faculty Member at the Faculté de Philosophie et Lettres, Université Libre de Bruxelles, Belgium.
- Tamás Demeter* (Lorenz Krüger Postdoctoral Research Fellow June 1, 2008–October 31, 2010) was appointed as Senior Research Fellow at the Institute of Philosophy, Research Centre for the Humanities, Hungarian Academy of Sciences, Budapest, Hungary.
- Thomas Ebke* (Predoctoral Research Fellow July 1–December 31, 2010) was appointed as Wissenschaftlicher Mitarbeiter at the DFG-Graduiertenkolleg „Lebensformen und Lebenswissen“, Universität Potsdam.
- Michael Elazar* (Postdoctoral Research Fellow September 1, 2009–June 30, 2011) was appointed as Researcher at the Minerva Humanities Center, Tel Aviv University, Israel.
- Andrew M. Fearnley* (Predoctoral Research Fellow September 1, 2009–June 30, 2010) was appointed as Senior Lecturer at the Edge Hill University, UK.
- Maja Fjaestad* (Predoctoral Research Fellow September 12, 2008–July 31, 2010) was appointed as Assistant Professor at the Division of History of Science and Technology, Royal Institute of Technology, Sweden.
- Judith Friedman* (Postdoctoral Research Fellow May 1–August 31, 2010) was appointed as Guest Scholar at the National Institute of Health, Washington, USA.
- Stefanie Gänger* (Predoctoral Research Fellow July 1–September 30, 2010) was appointed as Wissenschaftliche Mitarbeiterin at the Universität Konstanz, Germany.
- Nils Güttler* (Predoctoral Research Fellow November 1, 2008–July 31, 2011) was appointed as Research Fellow at the Forschungszentrum Gotha für kultur- und sozialwissenschaftliche Studien, Universität Erfurt, Germany.
- Daniela Helbig* (Predoctoral Research Fellow August 1–August 31, 2010) was appointed as Assistant Professor at the Unit for History and Philosophy of Science, The University of Sydney, Australia.

Catherine Herfeld (Predoctoral Research Fellow October 1–November 30, 2011 and January 1–March 31, 2012) was appointed as Research Fellow at the Duke University, Center for the History of Political Economy, USA.

Ina Heumann (Postdoctoral Research Fellow October 1–December 31, 2011) was appointed as Wissenschaftliche Mitarbeiterin at the Museum für Naturkunde, Berlin, Germany.

Christoph Hoffmann (Visiting Scholar June 15–July 31, 2010) was appointed as Professor at the Universität Luzern, Switzerland.

Ludmila Hyman (Postdoctoral Research Fellow September 1, 2007–August 31, 2011) was appointed as Postdoctoral Associate at the Carnegie Mellon University, USA.

Chihyung Jeon (Postdoctoral Research Fellow September 1, 2010–August 31, 2011) was appointed as Assistant Professor at the KAIST School of Humanities & Social Sciences, Graduate School of Science and Technology Policy, Daedeok Science Town, Republic of Korea.

Christian Joas (Research Scholar February 15, 2007–November 30, 2012) was appointed as Wissenschaftlicher Mitarbeiter at the Ludwig-Maximilians-Universität München, Germany.

Stefanie Klamm (Predoctoral Research Fellow October 1, 2010–March 31, 2011) was appointed as Wiss. Museumsassistentin at the Staatl. Museen zu Berlin, Germany.

Falk-Juri Knauff (Visiting Scholar January 1, 2012–December 31, 2011) was appointed as Landwirtschaftlicher Angestellter at the Land- und Forstwirtschaftliches Versuchszentrum Laimburg, Italy.

Fabian Krämer (Predoctoral Research Fellow September 1, 2006–February 28, 2011) was appointed as Wiss. Assistent at the Ludwig-Maximilians-Universität München, Germany.

Arie Krampf (Postdoctoral Research Fellow July 1, 2008–October 31, 2010) was appointed as Postdoctoral Fellow at the Otto-Suhr-Institut, Freie Universität Berlin, Germany.

Karin Krauthausen (Visiting Scholar April 1, 2008–February 18, 2013) was appointed as Wissenschaftliche Mitarbeiterin at the Humboldt-Universität zu Berlin, Germany.

Harun Küçük (Predoctoral Research Fellow January 1–June 30, 2012) was appointed as Lecturer at the Sabancı University and Istanbul Şehir University, Turkey.

Julia Kursell (Visiting Scholar November 1, 2011–January 31, 2013) was appointed as Professor at the University of Amsterdam, Netherlands.

Mike Laufenberg (Predoctoral Research Fellow August 5, 2009–October 31, 2010) was appointed as Wissenschaftlicher Mitarbeiter at the Zentrum für Interdisziplinäre Frauen- und Geschlechterforschung, Technische Universität Berlin, Germany.

Adam Lawrence (Predoctoral Research Fellow October 1, 2011–August 31, 2012) was appointed as Visiting Fellow at the Descartes Centre for the History and Philosophy of the Sciences and the Humanities, Utrecht, Netherlands.

Sophie Ledebur-Wicheln (Predoctoral Research Fellow October 1, 2010–January 31, 2011) was appointed as Wissenschaftliche Mitarbeiterin at the DFG-Forschergruppe “Kulturen des Wahnsinns”, Germany.

Kirsten Leng (Postdoctoral Research Fellow June 1–July 31, 2012) was appointed as Postdoctoral Fellow at the Northwestern University, USA.

Ximo Guillem Llobat (Postdoctoral Research Fellow October 1, 2009–March 31, 2010) was appointed as Profesor Ayudante at the Instituto de Historia de la Medicina y de la Ciencia López Piñero, Universitat de Valencia, Spain.

Robert Meunier (Postdoctoral Research Fellow May 1–June 30, 2012) was appointed as Fellow at the ICI Berlin, Germany.

John Mumma (Postdoctoral Research Fellow October 1, 2011–March 3, 2012) was appointed as Assistant Professor at the California State University, San Bernardino, USA.

Tania Munz (Research Scholar August 1, 2007–August 31, 2010) was appointed as Postdoctoral Fellow at the Northwestern University, USA.

Anindita Nag (Postdoctoral Research Fellow January 1–February 28, 2014) was appointed as Lecturer at the Department of History, College of Arts & Science, The University of Memphis, USA.

Omar W. Nasim (Postdoctoral Research Fellow August 1–August 31, 2011) was appointed as Senior Research Fellow at the ETH Zürich, Switzerland.

Lisa Onaga (Predoctoral Research Fellow July 1–October 31, 2010) was appointed as Assistant Professor at the School of Humanities and Social Sciences, Nanyang Technological University, Singapore.

Tino Plümecke (Predoctoral Research Fellow November 1, 2010–February 28, 2011) was appointed as Wissenschaftlicher Mitarbeiter at the Goethe-Universität Frankfurt am Main, Germany.

Christopher Plumb (Predoctoral Research Fellow September 1, 2009–February 28, 2010) was appointed as Lecturer at the Centre for Museology, University of Manchester, UK.

Albert Presas i Puig (Research Scholar August 12, 2008–September 30, 2010) was appointed as Associate Professor at the Universitat Pompeu Fabra; Barcelona, Spain.

Brigit Ramsingh (Predoctoral Research Fellow March 1–August 31, 2010) was appointed as Program Coordinator at the Charité Berlin, Institut für Geschichte der Medizin, Germany.

Ulla Kypta (Predoctoral Research Fellow January 1–June 30, 2012) was appointed as Wissenschaftliche Mitarbeiterin at the Historisches Seminar, Universität Frankfurt, Germany.

Dean Rickles (Postdoctoral Research Fellow October 14–November 11, 2010) was appointed as Associate Professor at the University of Sydney, Australia.

Sophia Roosth (Predoctoral Research Fellow February 1–July 31, 2010) was appointed as Assistant Professor at the Harvard University, USA.

Henning Schmidgen (Research Scholar July 1, 2006–March 31, 2011) was appointed as Professor at the Universität Regensburg, Germany.

Wolfgang Schmidle (Research Scholar September 1, 2008–August 31, 2011) was appointed as Wissenschaftlicher Mitarbeiter at the Deutsches Archäologisches Institut, Berlin, Germany.

Jeffrey Schwegman (Postdoctoral Research Fellow October 1, 2008–September 30, 2010) was appointed as Lecturer at the Stanford University, USA.

Jennifer Spinks (Postdoctoral Research Fellow January 2–February 28, 2012) was appointed as Assistant Professor at the University of Melbourne, Australia.

Max Stadler (Postdoctoral Research Fellow October 1, 2009–December 31, 2010) was appointed as Wissenschaftlicher Mitarbeiter at the ETH Zürich, Switzerland.

Pierre Teissier (Postdoctoral Research Fellow January 1–April 30, 2010) was appointed as Maître de Conférences at the Université de Nantes, France.

Christina Tsouparopoulou (Postdoctoral Research Fellow December 1, 2008–March 31, 2011) was appointed as Postdoctoral Researcher at the CRC 933 “Material Text Cultures”, University of Heidelberg, Germany.

Luděk Vacín (Postdoctoral Research Fellow April 1, 2010–June 30, 2012) was appointed as Wissenschaftlicher Mitarbeiter at the Exzellenzcluster TOPOI, Freie Universität Berlin, Germany.

Mauro Sebastián Vallejo (Predoctoral Research Fellow March 1–May 31, 2010) was appointed as Postdoctoral Fellow at the Consejo Nacional de Investigaciones Científicas y Técnicas, Argentina.

Fernando Vidal (Visiting Scholar February 1–February 17 and June 24–August 31, 2013) was appointed as Professor at the Universitat Autònoma de Barcelona, Spain.

Milena Wazeck (Research Scholar February 15, 2004–December 31, 2010) was appointed as Associate Research Scientist at the New York University, USA.

Christina Wessely (Postdoctoral Research Fellow March 1, 2009–May 9, 2010) was appointed as Wissenschaftliche Mitarbeiterin at the Humboldt-Universität zu Berlin, Germany.

Andrea Westermann (Postdoctoral Research Fellow September 1–December 31, 2010) was appointed as Oberassistentin at the Historisches Seminar, Universität Zürich, Switzerland.

Matthijs Weststeijn (Postdoctoral Research Fellow September 1–November 30, 2012) was appointed as Associate Professor at the University of Amsterdam, Netherlands.

Kelly J. Whitmer (Postdoctoral Research Fellow June 1, 2008–July 31, 2010) was appointed as Assistant Professor at the The University of the South, Sewanee, USA.

Per Wisselgren (Postdoctoral Research Fellow September 1–October 31, 2012) was appointed as Assistant Professor at the Umea University, Sweden.

Alexander Wragge-Morley (Predoctoral Research Fellow February 1–July 31, 2011) was appointed as Postdoctoral Fellow at the University of Oxford, UK.

Monika Wulz (Postdoctoral Research Fellow September 1–October 31, 2011) was appointed as Research Fellow at the IFK Wien, Austria.

Nasser Zakariya (Postdoctoral Research Fellow March 1–August 31, 2010) was appointed as Dibner Postdoctoral Fellow at the Department of Technology, Culture and Society, New York University, USA.

Awards at the History of Science Society Meeting 2012

Lorraine Daston, Director at the MPIWG, received the Sarton Medal,

Hans-Jörg Rheinberger, Director at the MPIWG, gave the Distinguished Lecture, and

Dagmar Schäfer, appointed as new MPIWG Director, won the Pfizer Prize.

Other Awards in Chronological Order

Lorraine Daston, Director at the MPIWG, received the medal Pour le Mérite.

Henning Schmidgen, Research Scholar at the MPIWG, received the Paul-Bunge-Preis 2010.

Lorraine Daston, Director at the MPIWG, received the German Federal Cross of Merit.

The Exhibition “Split+Splice: Fragments From the Age of Biomedicine”, co-curated by *Susanne Bauer*, Research Scholar at the MPIWG, received the “Dibner Award for Excellence in Museum Exhibits 2010”.

Dieter Hoffmann, Research Scholar at the MPIWG, received the Ehrennadel of the Deutsche Physikalische Gesellschaft.

Matteo Valleriani, Research Scholar at the MPIWG, received the Marc-Auguste-Pictet-Prize 2010 for his book “Galileo Engineer”.

Milena Wazeck, Research Scholar at the MPIWG until October 2010, received the award of the “Deutsche Gesellschaft für Geschichte der Medizin, Naturwissenschaft und Technik”.

Matteo Valleriani, Research Scholar at the MPIWG, received the Paul-Bunge-Prize 2011 for his book “Galileo Engineer”.

Jürgen Renn, Director at the MPIWG, received the “Premio Anassilaos International 2011.”

Fabian Krämer, former scholar at the MPIWG, received the “Johann-Lorenz-Bausch-Förderpreis.”

Lorraine Daston, Director at the MPIWG, received the Schelling-Prize of the Bavarian Academy of Sciences.

Martin Jähnert, Predoctoral Research Fellow, was awarded the Hanneke Janssen Memorial Prize 2012 from the Radboud University Nijmegen.

Estelle Blaschke, Predoctoral Research Fellow at the MPIWG from November 2009 to July 2011, received the Forschungspreis der Deutschen Gesellschaft für Fotografie.

Theresa Kelley, Visiting Scholar July–August 2011, won the Book Prize 2012 of the BSLs.

Publications

This bibliography comprises the publications of the Institute's members and guests during the period 2010–2012. Book reviews are not listed.

Bibliography editor: Sabine Bertram, MPIWG Library. Last update: March 4, 2013.

Abdounur, Oscar João. “Analogias e construção de significados : as relações entre a matemática e a música.” *Com Ciência* 116 (2010): 1–6.

Abdounur, Oscar João. “Geometry and theoretical music in the Renaissance.” In *Science & culture : promise, challenge and demand*, eds. Fanny Seroglou, Vassillis Koulountzos, and Anastasios Siatras. 16–9. Athens: Epikentro, 2011.

Abdounur, Oscar João. “Introduction of geometry and physics in theoretical music in the Renaissance.” In *History of the mathematical sciences II*, eds. Bhuri Singh Yadav and S. L. Singh. 205–222. Cambridge: Cambridge Scientific Publ., 2011.

Abdounur, Oscar João. “Analogical thought in teaching / learning dynamics : an epistemological approach on the interrelationships between mathematics and music.” In *Interdisciplinary approaches to neuroscience, epistemology, and cognition*, ed. Tobias A. Mattei. 65–92. New York: Nova Publishers, 2012.

Abdounur, Oscar João and Adriana Cesar de Mattos. “The introduction of the European university system in Brazil.” In *The globalization of knowledge in history*, ed. Jürgen Renn. 417–437. Berlin: epubli GmbH, 2012:
http://www.edition-open-access.de/studies/1/chapter_21.html

Allen, Keith R. and Christine von Oertzen. “Gestanzte Daten der Bevölkerung : die Urgeschichte der Lochkarte.” *Frankfurter Allgemeine Zeitung*, 24.11.2010, N5.

Amad, Paula. “From God's-eye to Camera-eye : aerial photography's and modernity's post-humanist and neo-humanist visions of the world.” *History of Photography* 36 (1 2012): 66–86.

- 1 Andretta, Elisa. *Roma medica : anatomie d'un système médical au XVIe siècle*. Collection de l'École Française de Rome ; 448. Rome: École Française de Rome, 2011.

Arabatzis, Theodore *see also* Kindi and Arabatzis

Arabatzis, Theodore *see also* Schickore and Arabatzis

Arabatzis, Theodore. "Electron." In *Eine Naturgeschichte für das 21. Jahrhundert : hommage à, zu Ehren von, in honor of Hans-Jörg Rheinberger*, 231–232. Berlin: Max-Planck-Institut für Wissenschaftsgeschichte, 2011.

Arabatzis, Theodore. "Hidden entities and experimental practice : renewing the dialogue between history and philosophy of science." In *Integrating history and philosophy of science : problems and prospects*, eds. Seymour Mauskopf and Tad Schmaltz. 125–139. Dordrecht: Springer, 2011.

Arabatzis, Theodore. "On the historicity of scientific objects." *Erkenntnis* 75 (3 2011): 377–390.

Arabatzis, Theodore. "Experimentation and the meaning of scientific concepts." In *Scientific concepts and investigative practice*, eds. Uljana Feest and Friedrich Steinle. 149–166. Berlin [u. a.]: de Gruyter, 2012.

Arabatzis, Theodore and Jutta Schickore. "Introduction: Ways of integrating history and philosophy of science." *Perspectives on Science* 20 (4 2012): 395–408.

Arnaud, Sabine. "L'art de vaporiser à propos : pourparlers entre un médecin et une marquise vaporeuse." *Cour de France.fr* (2011): 1–12:
<http://cour-de-france.fr/article2054.html>

Arnaud, Sabine. "Ruse and reappropriation in the French eighteenth century : 'La philosophy of the vapours' by C.-J. de B. de Paumerelle." *French Studies* 65 (2 2011): 174–187.

Arnaud, Sabine. "De la dénomination d'une maladie à son assignation : l'hystérie et la différence sexuelle, entre 1750 et 1820." In *Revisiter la „querelle des femmes“ : discours sur l'égalité / inégalité des sexes, de 1750 aux lendemains de la Révolution*, ed. Eliane Viennot. 131–147. Saint-Etienne: Publications de l'Université de Saint-Etienne, 2012.

Arnaud, Sabine. "Naissance de l'hystérie." *Sciences humaines : les grands dossiers* (28 2012): 52–54.

Arnaud, Sabine. "S/he who traps last traps best : the diagnosis of vapours and the writing of observations in late eighteenth-century France." In *Le corps et ses images dans l'Europe du dix-huitième siècle = The body and its images in eighteenth-century Europe*, eds. Sabine Arnaud and Helge Jordheim. 147–165. Paris: Champion, 2012.



- 2 Arnaud, Sabine and Helge Jordheim, eds. *Le corps et ses images dans l'Europe du dix-huitième siècle = The body and its images in eighteenth-century Europe*. Études internationales sur le dix-huitième siècle ; 13. Paris: Champion, 2012.

Aronova, Elena. "The congress for cultural freedom, Minerva, and the quest for instituting 'Science Studies' in the age of Cold War." *Minerva* 50 (3 2012): 307–337.

Aubin, David. "Eclipse politics in France and Thailand, 1868." In *The heavens on earth : observatories and astronomy in nineteenth-century science and culture*, eds. David Aubin, Charlotte Bigg, and H. Otto Sibum. 86–117. Durham, N.C. [u. a.]: Duke University Press, 2010.

- 3 Aubin, David, Charlotte Bigg, and H. Otto Sibum, eds. *The heavens on earth : observatories and astronomy in nineteenth-century science and culture*. Science and cultural theory. Durham, N. C. [u. a.]: Duke University Press, 2010.

Aubin, David, Charlotte Bigg, and H. Otto Sibum. "Introduction : observatory techniques in nineteenth-century science and society." In *The heavens on earth : observatories and astronomy in nineteenth-century science and culture*, eds. David Aubin, Charlotte Bigg, and H. Otto Sibum. 1–32. Durham, N. C. [u. a.]: Duke University Press, 2010.

Azzouni, Safia. "How Wilhelm Dilthey influenced popular science writing : Kurd Laßwitz's 'Homchen. Ein Tiermärchen aus der oberen Kreide.'" In *Historical perspectives on Erklären und Verstehen*, ed. Uljana Feest. 61–79. Dordrecht [u. a.]: Springer, 2010.

Azzouni, Safia. "Populärwissenschaft und Experiment." In *Experiment und Literatur : Themen, Methoden, Theorien*, ed. Michael Gamper. 463–483. Göttingen: Wallstein, 2010.

Azzouni, Safia. "Weltuntergänge, Kometen und Autodidakten um 1900." In *Things beyond control like love and art : zwanzig Jahre Akademie Schloss Solitude*, eds. Jean-Baptiste Joly and Nadine Jäger. 68–69. Stuttgart: Merz & Solitude, 2010.

Azzouni, Safia. "Wilhelm Bölsches populärwissenschaftliche Strategie der 'Humanisierung' : Dilettantismus als Orientierungswissen." In *Dilettantismus als Beruf*, eds. Safia Azzouni and Uwe Wirth. 83–94. Berlin: Kulturverlag Kadmos, 2010.

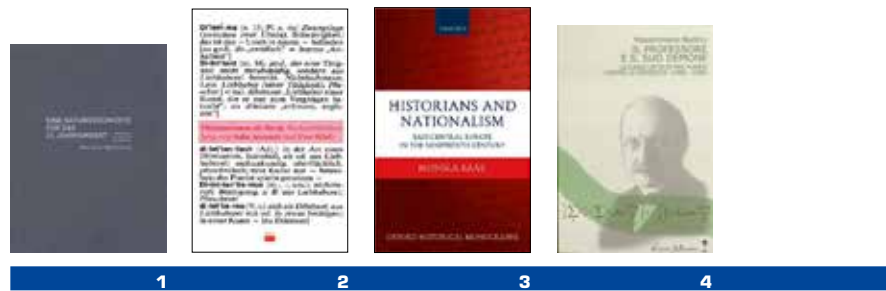

Azzouni, Safia. “Iguanodon.” In *Eine Naturgeschichte für das 21. Jahrhundert : hommage à, zu Ehren von, in honor of Hans-Jörg Rheinberger*, 100–101. Berlin: Max-Planck-Institut für Wissenschaftsgeschichte, 2011.

Azzouni, Safia. “Wie der Autor des ersten Kosmosbändchens entstand : der Autor im populärwissenschaftlichen Text.” In *‘Was wir im Verstande ausjäten, kommt im Traume wieder’ : Wilhelm Bölsche 1861–1939*, eds. Gerd-Hermann Susen and Edith Wack. 319–341. Würzburg: Königshausen & Neumann, 2012.

- 1 Azzouni, Safia, Christina Brandt, Bernd Gausemeier, Julia Kursell, Henning Schmidgen, and Barbara Wittmann, eds. *Eine Naturgeschichte für das 21. Jahrhundert : hommage à, zu Ehren von, in honor of Hans-Jörg Rheinberger*. Berlin: Max-Planck-Institut für Wissenschaftsgeschichte, 2011.

Azzouni, Safia, Christina Brandt, Bernd Gausemeier, Julia Kursell, and Barbara Wittmann. “Vorwort/ Preface.” In *Eine Naturgeschichte für das 21. Jahrhundert : hommage à, zu Ehren von, in honor of Hans-Jörg Rheinberger*, 6–16. Berlin: Max-Planck-Institut für Wissenschaftsgeschichte, 2011.

- 2 Azzouni, Safia and Uwe Wirth, eds. *Dilettantismus als Beruf*. Kaleidogramme ; 43. Berlin: Kulturverlag Kadmos, 2010.

Azzouni, Safia and Uwe Wirth. “Vorbemerkung.” In *Dilettantismus als Beruf*, eds. Safia Azzouni and Uwe Wirth. 7–9. Berlin: Kulturverlag Kadmos, 2010.

- 3 Baár, Monika. *Historians and nationalism : East-central Europe in the nineteenth century*. Oxford historical monographs. Oxford [u. a.]: Oxford University Press, 2010.

Bacht, Nikolaus, ed. *Listening : interdisciplinary perspectives*. Journal of the Royal Musical Association ; 135/Suppl. 1. London: Routledge, 2010.

- 4 Badino, Massimiliano. *Il professore e il suo demone : la lunga lotta di Max Planck contro la statistica, 1896–1906*. Meccanismi ; 10. Milano: Melquíades, 2010.

Badino, Massimiliano. “Das Verfolgen einer Idee : Plancks Theorie idealer Gase.” In *Max Planck und die moderne Physik*, ed. Dieter Hoffmann. 135–148. Berlin: Springer, 2010.



5

Badino, Massimiliano. “Mechanistic slumber vs. statistical insomnia : the early phase of Boltzmann’s H-theorem (1868–1877).” *The European Physical Journal H* 36 (3 2011): 353–378.

Badino, Massimiliano. “Productive conservatism : Planck’s second theory of radiation.” *Annalen der Physik* 524 (2 2012): A29–A31.

- 5 Barahona, Ana, Edna Suárez Díaz, and Hans-Jörg Rheinberger. *Darwin, el arte de hacer ciencia : las prensas de ciencias*. Mexico City: Universidad Nacional Autónoma de Mexico, 2011.

Barahona, Ana, Edna Suárez Díaz, and Hans-Jörg Rheinberger. “Introducción.” In *Darwin, el arte de hacer ciencia : las prensas de ciencias*, eds. Ana Barahona, Edna Suárez Díaz, and Hans-Jörg Rheinberger. 9–27. Mexico City: Universidad Nacional Autónoma de Mexico, 2011.

Bauer, Susanne *see also Schlünder, Reiß, Hüntelmann and Bauer*

Bauer, Susanne. “Nutrigenomik : technowissenschaftliches Fine-Tuning von Nahrung und Körper.” In *Essen in Europa : kulturelle ‘Rückstände’ in Nahrung und Körper*, eds. Susanne Bauer, Christine Bischof, Stephan Gabriel Haufe, Stefan Beck, and Leonore Scholze-Irrlitz. 163–190. Bielefeld: Transcript, 2010.

Bauer, Susanne. “Appréhender le social dans la recherche épidémiologique : vers une politique des associations statistiques?” In *De la vie biologique à la vie sociale : approches sociologiques et anthropologiques*, eds. Joëlle Vailly, Janina Kehr, and Jörg Niewöhner. 298–327. Paris: La Découverte, 2011.

Bauer, Susanne. “Formation des ‘Sozialen’ in Biomedizin und Lebenswissenschaften : eine Politik der Assoziationen?” In *Leben in Gesellschaft : Biomedizin – Politik – Sozialwissenschaften*, eds. Jörg Niewöhner, Janina Kehr, and Joëlle Vailly. 331–359. Bielefeld: Transcript, 2011.

Bauer, Susanne. “Kommentar: Verteilte Handlungsmacht im Experiment – Von der Epistemologie zu multiplen Ontologien.” *Berichte zur Wissenschaftsgeschichte* 35 (4 2012): 341–350.

- 1 Bauer, Susanne, Christine Bischof, Stephan Gabriel Haufe, Stefan Beck, and Leonore Scholze-Irrlitz, eds. *Essen in Europa : kulturelle 'Rückstände' in Nahrung und Körper. Verkörperungen* ; 5. Bielefeld: Transcript, 2010.

Becchi, Antonio. "Architecture as a mechanical problem : a 'new' Renaissance manuscript and some old stories." In *Mechanics and architecture between epistémé and téchné : in commemoration of Edoardo Benvenuto (1940–1998) on the tenth anniversary, Rome, December 5, 2008*, ed. Anna Sinopoli. 97–106. Roma: Ed. di Storia e Letteratura, 2010.

Becchi, Antonio. "Lasino che vola : architettura, ricerca, metodi tossici." In *Actas Tercera Jornadas Sobre Investigación en Arquitectura y Urbanismo (Madrid, 17–19 Junio 2009)*, eds. E. Rabasa, J. Ibáñez, and D. Sanz. XXXIV–XLVII. Madrid: Maira Libros, 2010.

Becchi, Antonio. "La doppia vita di una mauvaise règle : la regola di Derand tra Leon Battista Alberti e Simone Stratico." In *Geometría y proporción en las estructuras : ensayos en honor de Ricardo Aroca*, eds. Pepa Cassinello, Santiago Huerta, José Miguel de Prada Poole, and Ricardo Sánchez Lampreave. 123–139. Madrid: Lampreave, 2010.

Becchi, Antonio. "Histoire de la construction : un regard italien." In *Édifice et artifice : histoires constructives ; recueil de textes issus du premier congrès francophone d'histoire de la construction, Paris, 19–21 juin 2008*, eds. Robert Carvais, André Guillerme, Valerie Nègre, and Joel Sakarovitch. 59–63. Paris: Picard, 2010.

Becchi, Antonio. "Cantieri d'inchostro : meccanica teorica e meccanica chirurgica nella seconda metà del Cinquecento." In *Studi su Domenico Fontana 1543–1607*, eds. Giovanna Curcio, Nicola Navone, and Sergio Villari. 91–103. Cinisello Balsamo (Milano): Silvana Editoriale [u. a.], 2011.

Becchi, Antonio. "Il corpo dell'inventio : Vitruvio interprete di Archimede." *Horti Hesperidum* 2 (2 2012): 39–60:
<http://www.horti-hesperidum.com/showrivista.php?item=151>

Becchi, Antonio. "La poutre brisée : une question, deux réponses." In *L'architrave, le plancher, la plate-forme : nouvelle histoire de la construction*, ed. Roberto Gargiani. 316–328. Lausanne: Presses polytechniques et universitaires romandes, 2012.

Becchi, Antonio. "Ut unum sint : poutres, arcs, plates-bandes." In *L'architrave, le plancher, la plate-forme : nouvelle histoire de la construction*, ed. Roberto Gargiani. 329–340. Lausanne: Presses polytechniques et universitaires romandes, 2012.

Beckmann, Jenny. "Das Linné-Projekt : die Mobilisierung von Amateur-Botanikern in Schweden zwischen 1972 und 1986." In *Dilettantismus als Beruf*, eds. Safia Azzouni and Uwe Wirth. 163–180. Berlin: Kulturverlag Kadmos, 2010.

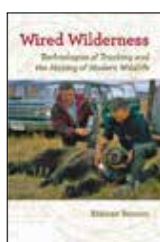

1

2

Beek, Viola van. “Experimentelle Ästhetik bei Kleist ? ‘Plötzliche Wendungen,’ ‘drängende Umstände’ und ‘sonderbare Erscheinungen’ in Heinrich von Kleists Erzählungen.” In *Wir sind Experimente : wollen wir es auch sein!*, eds. Michael Gamper, Martina Wernli, and Jörg Zimmer. 100–120. Göttingen: Wallstein, 2010.

- 2 Benson, Etienne. *Wired wilderness : technologies of tracking and the making of modern wildlife*. Animals, history, culture. Baltimore, Md.: The Johns Hopkins University Press, 2010.

Benson, Etienne. “Animal writes : historiography, disciplinarity, and the animal trace.” In *Making animal meaning*, eds. Linda Kalof and Georgina M. Montgomery. 3–16. East Lansing: Michigan State University Press, 2011.

Benson, Etienne. “A difficult time with the permit process.” *Journal of the History of Biology* 44 (1 2011): 103–123.

Benson, Etienne. “From wild lives to wildlife and back.” *Environmental History* 16 (3 2011): 418–422.

Benson, Etienne. “Demarcating wilderness and disciplining wildlife : radiotracking large carnivores in Yellowstone and Chitwan National Parks.” In *Civilizing nature : national parks in global historical perspective*, eds. Bernhard Gissibl, Sabine Höhler, and Patrick Kupper. 173–188. New York: Berghahn Books, 2012.

Benson, Etienne. “One infrastructure, many global visions : the commercialization and diversification of Argos, a satellite-based environmental surveillance system.” *Social Studies of Science* 42 (6 2012): 846–871.

Benson, Etienne. “Endangered science: the regulation of research by the U.S. Marine Mammal Protection and Endangered Species Acts.” *Historical Studies in the Natural Sciences* 42 (1 2012): 30–61.

Bergmann, Sven. “Fertility tourism : circumventive routes that enable access to reproductive technologies and substances.” *Signs: Journal of Women in Culture and Society* 36 (2 2011): 280–289.



Bergmann, Sven. “Reproductive agency and projects : Germans searching for egg donation in Spain and the Czech Republic.” *Reproductive BioMedicine Online* 23 (5 2011): 600–608.

Bergmann, Sven. “Reproduktives Reisen.” *GID. Gen-ethischer Informationsdienst* (204 2011): 33–35:
<http://www.gen-ethisches-netzwerk.de/gid/204/bergmann/reproduktives-reisen>

Bergua, Antonio, Ulrich Schoenherr, and Frank W. Stahnisch. “Albert Neisser’s (1855–1916) ‘Stereoscopischer Medizinischer Atlas’ – Eine Pionierarbeit der 3D-Fotografie in der Geschichte der Augenheilkunde.” *Klinische Monatsblätter für Augenheilkunde* 227 (5 2010): 433–438.

Berson, Joshua *see also Dobrin and Berson*

Berson, Joshua. “Intellectual property and cultural appropriation.” *Reviews in Anthropology* 39 (3 2010): 201–228.

Berson, Joshua. “Ideologies of descent in linguistics and law.” *Language & Communication* 32 (2 2012): 137–146.

Bethke, Berit. “Bodies on display : die Aufbereitung von Körperwissen in trans-kulturellen Ausstellungsmedien des Deutschen Hygiene-Museums Dresden (1950–1980).” In *Körperwissen*, eds. Reiner Keller and Michael Meuser. 249–269. Wiesbaden: VS-Verlag, 2011.

Beyler, Richard H., Michael Eckert, and Dieter Hoffmann. “The Planck medal.” In *The German Physical Society and the Third Reich : physicists between autonomy and accommodation*, eds. Dieter Hoffmann and Mark Walker. 169–186. New York: Cambridge University Press, 2012.

Bigg, Charlotte *see also Aubin and Bigg*

Bigg, Charlotte. “Staging the heavens : astrophysics and popular astronomy in the late nineteenth century.” In *The heavens on earth : observatories and astronomy in nineteenth-century science and culture*, eds. David Aubin, Charlotte Bigg, and H. Otto Sibum. 305–324. Durham, N. C. [u. a.]: Duke University Press, 2010.

Bigg, Charlotte. "A visual history of Jean Perrin's Brownian motion curves." In *Histories of scientific observation*, eds. Lorraine Daston and Elizabeth Lunbeck. 156–179. Chicago: University of Chicago Press, 2011.

Bigg, Charlotte, David Aubin, and David Felsch. "Introduction: The laboratory of nature – science in the mountains." *Science in Context* 22 (3 2010): 311–321.

- 1 Blum, André L., John Michael Krois, and Hans-Jörg Rheinberger, eds. *Verkörperungen. Actus et imago* ; 6. Berlin: Akademie Verlag, 2012.

Blum, Alexander S., Jürgen Renn, Donald C. Salisbury, Matthias Schemmel, and Kurt Sundermeyer. "1912 : a turning point on Einstein's way to general relativity." *Annalen der Physik* 524 (1 2012): A11–A13.

Bödeker, Katja. "Hast du Beweise? Über die Glaubwürdigkeit von Wundern." In *Wunderforschung : ein Experiment von Kindern, Wissenschaftlern und Künstlern*, eds. Katja Bödeker and Carmen Hammer. 20–34. Berlin: Nicolai, 2010.

Bödeker, Katja. "Monstervölker am Rande der Welt." In *Wunderforschung : ein Experiment von Kindern, Wissenschaftlern und Künstlern*, eds. Katja Bödeker and Carmen Hammer. 110–117. Berlin: Nicolai, 2010.

Bödeker, Katja. "Was die Natur erlaubt oder verbietet : über das Wesen der Arten." In *Wunderforschung : ein Experiment von Kindern, Wissenschaftlern und Künstlern*, eds. Katja Bödeker and Carmen Hammer. 46–53. Berlin: Nicolai, 2010.

Bödeker, Katja and Carmen Hammer. "Gemeinsam forschen." In *Wunderforschung : ein Experiment von Kindern, Wissenschaftlern und Künstlern*, eds. Katja Bödeker and Carmen Hammer. 6–10. Berlin: Nicolai, 2010.

- 2 Bödeker, Katja and Carmen Hammer, eds. *Wunderforschung : ein Experiment von Kindern, Wissenschaftlern und Künstlern*. Schriften der Werkstatt des Wissens. Berlin: Nicolai, 2010.

Bödeker, Katja and Carmen Hammer. "Staunen – Wundern – Forschen." *Reli : Zeitschrift für Religionsunterricht* (3 2012): 3–6.

- 3 Borchers, Stefan. *Die Erzeugung des 'ganzen Menschen' : zur Entstehung von Anthropologie und Ästhetik an der Universität Halle im 18. Jahrhundert*. Hallesche Beiträge zur Europäischen Aufklärung ; 42. Berlin: de Gruyter, 2011.

Borchers, Stefan. "Hydra viridis." In *Eine Naturgeschichte für das 21. Jahrhundert : hommage à, zu Ehren von, in honor of Hans-Jörg Rheinberger*, 147–149. Berlin: Max-Planck-Institut für Wissenschaftsgeschichte, 2011.

Borchers, Stefan. "Psychophysische Präexistenz : Leibniz' Antwort auf die Frage nach dem Ursprung der menschlichen Seele in der 'Théodicée.'" In *Natur und*

Subjekt : IX. Internationaler Leibniz-Kongress, Vorträge. Vol. 1, eds. Herbert Breger, Jürgen Herbst, and Sven Erdner. 105–110. Hannover: Gottfried-Wilhelm-Leibniz-Gesellschaft, 2011.

Borchers, Stefan. “Sexualaufklärung in der deutschen Aufklärung : Christian Wolff über die Erzeugung des Menschen.” *Sexuologie* 18 (3/4 2011): 176–184.

Borchers, Stefan. “Totus homo oder ganzer Mensch? Zum Auftakt der Anthropologie an der Universität Halle.” In *Die Sachen der Aufklärung : Beiträge zur DGEJ-Jahrestagung 2010 in Halle a. d. Saale*, eds. Frauke Bernd and Daniel Fulda. 552–559. Hamburg: Meiner, 2012.

- 1 Borchers, Stefan, ed. *Christian Wolff: Gesammelte Werke. Abt. 3: Materialien und Dokumente. Bd. 130: Vier Schriften zum Ende von Wolffs erster Lehrperiode an der Universität Halle*. Hildesheim [u. a.]: Olms, 2012.

Borchers, Stefan. “Vorwort.” In *Christian Wolff: Gesammelte Werke. Abt. 3: Materialien und Dokumente. Bd. 130: Vier Schriften zum Ende von Wolffs erster Lehrperiode an der Universität Halle*, ed. Stefan Borchers. VII–XVII. Hildesheim [u. a.]: Olms, 2012.

Borchers, Stefan. “[Entry] ‘Wolffianismus.’” In *Enzyklopädie der Neuzeit. Vol. 15: Wissen – Zyklichkeit, Nachträge*, ed. Friedrich Jaeger. 226–230. Stuttgart [u. a.]: Metzler, 2012.

Bordogna, Francesca, ed. *William James: Il significato della verità : una prosecuzione di ‘Pragmatismo’*. Filosofia. Torino: Aragno, 2010.

Bordoni, Stefano. “Unearthing a buried memory : Duhem’s third way to thermodynamics. Part 1.” *Centaurus* 54 (2 2012): 124–147.

Bordoni, Stefano. “Unearthing a buried memory : Duhem’s third way to thermodynamics. Part 2.” *Centaurus* 54 (3 2012): 232–249.

- 2 Boreczky, Anna and András Németh, eds. *Apollonius Pictus : an illustrated late antique romance around 1000 ; facsimile edition of the historia Apollonii Regis Tyri (National Széchényi Library, Budapest, Cod. Lat. 4)*. Budapest: National Széchényi Library, 2011.

Borrelli, Arianna. “Die bewegende Kraft des Feuers : Naturgeheimnisse und ‘nutzlose’ Technik in der Frühen Neuzeit.” *Praxis der Naturwissenschaften* 59 (4 2010): 5–10.

Borrelli, Arianna. “Crystallogly in the making.” In *Variantology 4 : on deep time relations of arts, sciences and technologies in the Arabic-Islamic world and beyond*, eds. Siegfried Zielinski and Eckhard Furlus. 53–86. Köln: König, 2010.



Borrelli, Arianna. “Dirac’s bra-ket notation and the notion of a quantum state.” In *Styles of thinking in science and technology : proceedings of the 3rd International Conference of the European Society for the History of Science ; Vienna, September 10–12, 2008 (CD-ROM)*, eds. Hermann Hunger, Felicitas Seebacher, and Gerhard Holzer. 361–371. Wien: Verlag der Österreichischen Akademie der Wissenschaften, 2010.

Borrelli, Arianna. “Die Reproduktion des Temperaturbegriffs.” In *Epistemologie und Differenz : zur Reproduktion des Wissens in den Wissenschaften*, eds. Bettina Bock von Wülfinen and Ute Frietsch. 59–82. Bielefeld: Transcript, 2010.

Borrelli, Adrianna. “Angular momentum between physics and mathematics.” In *Mathematics meets physics : a contribution to their interaction in the 19th and the first half of the 20th century*, eds. Karl-Heinz Schlote and Martina Schneider. 395–440. Frankfurt am Main: Deutscher, 2011.

Borzeszkowski, Horst-Heino von and Renate Wahsner. “[Entries] ‘Maß’, ‘Machsches Prinzip.’” In *Enzyklopädie Philosophie. Vol. 2*, ed. Hans Jörg Sandkühler. 2. Auflage. Hamburg: Meiner, 2010.

3 Borzeszkowski, Horst-Heino von and Renate Wahsner. *Das physikalische Prinzip : der epistemologische Status physikalischer Weltbetrachtung*. Würzburg: Königshausen & Neumann, 2012.

4 Bose, Sugata and Kris K. Manjappa, eds. *Cosmopolitan thought zones : South Asia and the global circulation of ideas*. Palgrave MacMillan Transnational History. Houndmills [u. a.]: Palgrave Macmillan, 2010.

Bour, Pierre Edouard and Sophie Roux, eds. *Lambertiana : hommage à Jacques Lambert*. Recherches sur la philosophie et le langage. Paris: Vrin, 2010.

Bourguet, Marie-Noelle. “A portable world : the notebooks of European travellers (18th to 19th centuries).” *Intellectual History Review* 20 (3 2010): 377–400.

Brancaforte, Elio and Sonja Brentjes, eds. *From rhubarb to rubies : European travels to Safavid Iran (1550–1700) ; The Lands of the Sophi : Iran in Early Modern European Maps (1550–1700)*. *Harvard library bulletin* ; 23.1–2. Cambridge, Mass.: Harvard College Library, 2012.

Brandt, Christina *see also* Azzouni and Brandt

Brandt, Christina. "Zeitschichten des Klons : Anmerkungen zu einer Begriffsgeschichte." *Berichte zur Wissenschaftsgeschichte* 33 (2 2010): 123–146.

Brandt, Christina. "Tomoffel." In *Eine Naturgeschichte für das 21. Jahrhundert : hommage à, zu Ehren von, in honor of Hans-Jörg Rheinberger*, 68–70. Berlin: Max-Planck-Institut für Wissenschaftsgeschichte, 2011.

Brandt, Christina. "Stem cells, reversibility, and reprogramming : historical perspectives." In *Differing routes towards stem cell research : Germany and Italy*, eds. Renato G. Mazzolini and Hans-Jörg Rheinberger. 55–91. Bologna [u. a.]: Società editrice il Mulino [u. a.], 2012.

Bray, Francesca. "Connecting with the past? A commentary." *East Asian Science, Technology and Society* 4 (2 2010): 327–333.

Bray, Francesca. "Ginotécnica y civilización." *Lectora : revista de dones i textualitat* 16 (2010): 81–92.

Bray, Francesca. "How blind is love? : Simon Winchester's The Man Who Loved China." *Technology and Culture* 51 (3 2010): 578–588.

Bray, Francesca. "Chinese literati and the transmission of technological knowledge : the case of agriculture." In *Cultures of knowledge : technology in Chinese history*, ed. Dagmar Schäfer. 299–325. Leiden [u. a.]: Brill, 2012.

Bréard, Andrea. "Knowledge and practice of mathematics in late-Ming daily-life encyclopedias." In *Looking at it from Asia : the processes that shaped the sources of history of science*, ed. Florence Bretelle-Establet. 305–329. Dordrecht [u. a.]: Springer, 2010.

Bréard, Andrea. "Usages et destins des savoirs mathématiques dans les Encyclopédies aux dix mille trésors." In *Pratiques lettrées au Japon et en Chine XVIIe –XIXe siècle*, eds. Annick Horiuchi and Daniel Struve. 103–123. Paris: Les Indes savantes, 2010.

Bredenkamp, Horst and Hans-Jörg Rheinberger. "Die neue Dimension des Unheimlichen." *Der Tagesspiegel*, 13.01 2012, B5.

Brentjes, Sonja *see also* Brancaforte and Brentjes

Brentjes, Sonja. "Eloges : Hans Wußing, 1927–2011." *Isis* 103 (2 2012): 371–375.

Brentjes, Sonja. "Medieval Portolan charts as documents of shared cultural spaces." In *Acteurs des transferts culturels en Méditerranée médiévale*, eds. Rania Abdellatif,

Yassir Benhima, Daniel König, and Elisabeth Ruchaud. 135–146. München: Oldenbourg, 2012.

Brentjes, Sonja. “Medieval portolan charts as documents of shared cultural spaces.” In *Acteurs des transferts culturels en Méditerranée médiévale*, eds. Rania Abdellatif, Yassir Benhima, Daniel König, and Elisabeth Ruchaud. 134–145. München: Oldenbourg, 2012.

Brentjes, Sonja. “On two manuscripts by Abu Bakr b. Bahram al-Dimashqi (d. 1102/1691) related to W. ad J. Blaeu’s Atlas Maior.” *Journal of Ottoman Studies = Osmanlı araştırmaları* 40 (2012): 171–220.

Brentjes, Sonja. “The presence of ancient secular and religious texts in Pietro della Valle’s (1586–1652) unpublished and printed writings.” In *Iran and the world in the Safavid age*, eds. Willem Floor and Edmund Herzig. 327–346. London: Tauris, 2012.

Brusius, Mirjam. “Beyond photography : an introduction to William Henry Fox Talbot’s notebooks in the Talbot Collection at the British Library.” *British Library Electronic Journal* (Article 14 2010): 1–31:
<http://www.bl.uk/ebj/2010articles/pdf/ebjarticle142010.pdf>

Brusius, Mirjam. “Impreciseness in Julia Margaret Cameron’s portrait photography.” *History of Photography* 34 (4 2010): 342–355.

Brusius, Mirjam. “Re-inventing Sinai : biblical myth, photographic imagination and the arrival of tourism.” In *Go down, Moses : a book on South Sinai*, ed. Ahmad Hosni. 16–23. Cairo: Contemporary Image Collective, 2010.

Brusius, Mirjam. “The Wilkinson Album (Metropolitan Museum of Art).” In *La Persia Qajar : fotografi italiani in Iran 1848–1864*, eds. Maria Francesca Bonetti and Alberto Prandi. 178–179. Roma: Peliti Associati, 2010.

Brusius, Mirjam. “Experimente ohne Ausgang : Talbot, Fenton und die Fotografie am British Museum um 1850.” *Fotogeschichte* 31 (122 2011): 13–22.

Brusius, Mirjam. “Naser al-Din Schah und die frühe Fotografie in Persien.” In *Tehran 50 : ein halbes Jahrhundert deutsche Archäologie in Iran*, eds. Barbara Helwing and Patricia Rahemipour. 10–12. Darmstadt: Philipp von Zabern, 2011.

Brusius, Mirjam. “Misfit objects : Layard’s excavations in ancient Mesopotamia and the biblical imagination in mid-nineteenth century Britain.” *Journal of Literature and Science* 5 (1 2012): 38–52: http://literatureandscience.research.glam.ac.uk/media/files/documents/2012-10-04/Brusius_Misfit_Objects_38-52.pdf

Caianiello, Silvia. “Biological modules.” In *Eine Naturgeschichte für das 21. Jahrhundert : hommage à, zu Ehren von, in honor of Hans-Jörg Rheinberger*, 227–229. Berlin: Max-Planck-Institut für Wissenschaftsgeschichte, 2011.



Callard, Felicity *see also Papoulias and Callard*

Callard, Felicity. “The vicissitudes of the recovery construct : or, the challenge of taking ‘subjective experience’ seriously.” *World Psychiatry* 11 (3 2012): 168–169: <http://www.ncbi.nlm.nih.gov/pmc/articles/PMC3449363/>

Callard, Felicity and Daniel S. Margulies. “The subject at rest : novel conceptualizations of self and brain from cognitive neuroscience’s study of the ‘resting state.’” *Subjectivity* 4 (3 2011): 227–257.

Callard, Felicity and Diane Rose. “The mental health strategy for Europe : why service user leadership in research is indispensable.” *Journal of Mental Health* 21 (3 2012): 219–226.

Callard, Felicity, Diane Rose, Emma-Louise Hanif, Jody Quigley, Kathryn Greenwood, and Til Wykes. “Holding blame at bay? ‘Gene talk’ in family members’ accounts of schizophrenia aetiology.” *BioSocieties* 7 (3 2012): 273–293: <http://dx.doi.org/10.1057/biosoc.2012.12>

- 1 Callard, Felicity, Norman Sartorius, Julio Arboleda-Flórez, and Peter Bartlett. *Mental illness, discrimination, and the law : fighting for social justice*. Chichester, West Sussex: Wiley-Blackwell, 2012.

Callard, Felicity, Jonathan Smallwood, and Daniel S. Margulies. “Default positions : how neuroscience’s historical legacy has hampered investigation of the resting mind.” *Frontiers in Psychology* 3 (321 2012): 1–6: <http://dx.doi.org/10.3389/fpsyg.2012.00321>

- 2 Chabot, Hugues and Sophie Roux, eds. *La mathématisation comme problème*. Paris: Edition des archives contemporaines, 2011.
- 3 Chamayou, Grégoire. *Les chasses à l'homme : histoire et philosophie du pouvoir cynégétique*. Paris: La Fabrique, 2010.
- 4 Chamayou, Grégoire. *Les corps vils : expérimenter sur les êtres humains aux XVIIIe et XIXe siècles*. Les empêcheurs de penser en rond. Paris: La Découverte, 2010.



5

Cheung, Tobias. “Cambridge platonism and the problem of organic regulation in Le Clerc’s *Bibliothèque choisie* (1703–1706).” In *Echanges franco-britanniques entre savants depuis le XVIIe siècle = Franco-British interactions in science since the seventeenth century*, eds. Robert Fox and Bernard Joly. 45–66. London: College Publications, 2010.

Cheung, Tobias. “Embodied stimuli : Bonnet’s statue of a sensitive agent.” In *The body as object and instrument of knowledge : embodied empiricism in early modern science*, eds. Charles T. Wolfe and Ofer Gal. 309–331. Dordrecht [u. a.]: Springer, 2010.

Cheung, Tobias. “Omnis fibra ex fibra : fibre oeconomies in Bonnet’s and Diderot’s models of organic order.” *Early Science and Medicine* 15 (1–2 2010): 66–104.

Cheung, Tobias. “What is an ‘organism’? : on the occurrence of a new term and its conceptual transformations 1680–1850.” *History and Philosophy of the Life Sciences* 32 (2–3 2010): 155–194.

Cheung, Tobias. “Comtes Milieutheorie proleptisch-reaktiver Organismen.” *Laufener Spezialbeiträge* (2011): 84–89.

Cheung, Tobias. “Faser.” In *Eine Naturgeschichte für das 21. Jahrhundert : hommage à, zu Ehren von, in honor of Hans-Jörg Rheinberger*, 221–222. Berlin: Max-Planck-Institut für Wissenschaftsgeschichte, 2011.

Cheung, Tobias. “Metabolic megastructures for flâneurs = Megaestructuras metabólicas para flâneurs.” In *Metropol Parasol : J. Mayer H.*, eds. Andres Lepik and Andre Santer. 35–40. Ostfildern: Hatje Cantz, 2011.

- 5 Chia, Lucille and Hilde De Weerd, eds. *Knowledge and text production in an age of print : China, 900–1400*. Sinica Leidensia ; 100. Leiden [u.a.]: Brill, 2011.

Choudhury, Suparna *see also Fricke and Choudhury*

Choudhury, Suparna *see also Slaby and Choudhury*



- 1 Choudhury, Suparna and Jan Slaby, eds. *Critical neuroscience : a handbook of the social and cultural contexts of neuroscience*. Chichester: Wiley-Blackwell, 2012.

Choudhury, Suparna and Jan Slaby. "Introduction: Critical neuroscience – Between lifeworld and laboratory." In *Critical neuroscience : a handbook of the social and cultural contexts of neuroscience*, eds. Suparna Choudhury and Jan Slaby. 1–26. Chichester: Wiley-Blackwell, 2012.

- 2 Clarke, Mark, Bert De Munck, and Sven Dupré, eds. *Transmission of artists' knowledge (16 June 2011)*. Contactforum. Brussel: KVAB, 2012.

Damerow, Peter *see also Kantel and Damerow*

Damerow, Peter *see also Renn and Damerow*

Damerow, Peter. "From numerate apprenticeship to divine quantification. Review of: Robson, Eleanor: *Mathematics in ancient Iraq : a social history*. Princeton [u. a.]: Princeton University Press 2008." *Notices of the American Mathematical Society* 57 (3 2010): 380–384.

Damerow, Peter. "The origins of writing and arithmetic." In *The globalization of knowledge in history*, ed. Jürgen Renn. 153–173. Berlin: epubli GmbH, 2012: http://www.edition-open-access.de/studies/1/chapter_9.html

Damerow, Peter and Jürgen Renn. "The transformation of ancient mechanics into a mechanistic world view." In *Transformationen antiker Wissenschaften*, eds. Georg Toepfer and Hartmut Böhme. 243–267. Berlin: de Gruyter, 2010.

Daston, Lorraine. "Die Glasblumen." In *Mit den Dingen leben : zur Geschichte der Alltagsgegenstände*, eds. Anke Ortlepp and Christoph Ribbat. 123–153. Stuttgart: Steiner, 2010.

Daston, Lorraine. "Human nature is a garden." *Interdisciplinary Science Reviews* 35 (3/4 2010): 215–230.

Daston, Lorraine. "The Humboldtian gaze." In *Science as cultural practice. Vol. 1: Cultures and politics of research from the early modern period to the age of extremes*, eds. Moritz Epple and Klaus Zittel. 45–60. Berlin: Akademie Verlag, 2010.

Daston, Lorraine. "Plötzlich." In *Olafur Eliasson : Innen Stadt Außen. Inner city out ; Exhibition catalogue*, ed. Daniel Birnbaum. 157–163. Köln: König, 2010.

Daston, Lorraine. "Pourquoi la nature a-t-elle une autorité morale, et doit-elle en avoir une?" In *Darwin : 200 ans ; colloque annuel 2009*, ed. Alain Prochiantz. 243–258. Paris: Odile Jacob, 2010.

Daston, Lorraine. "Suddenly." In *Olafur Eliasson : Innen Stadt Außen. Inner city out ; Exhibition catalogue*, ed. Daniel Birnbaum. 164–166. Köln: König, 2010.

Daston, Lorraine. "The world in order." In *Without nature? : a new condition for theology*, eds. David Albertson and Cabell King. 15–33. New York: Fordham University Press, 2010.

Daston, Lorraine. "‘Alles, was zählt, sind die Ideen’ [Interview]." In *Geschichte als Passion : über das Entdecken und Erzählen der Vergangenheit ; zehn Gespräche*, eds. Alexander Kraus and Birte Kohtz. 237–264. Frankfurt/M. [u. a.]: Campus, 2011.

Daston, Lorraine. "Doppelgänger : la science au miroir de l'art, histoires parallèles." *Perspective : la revue de l'Institut National d'Histoire de l'Art* (3 2011): 405–407.

Daston, Lorraine. "The Empire of observation, 1600–1800." In *Histories of scientific observation*, eds. Lorraine Daston and Elizabeth Lunbeck. 81–113. Chicago: University of Chicago Press, 2011.

Daston, Lorraine. "Fiktionen der Objektivität [Interview]." In *Klimakunstforschung*, eds. Friedrich von Borries, Christian Hiller, and Wilma Renfordt. 170–180. Berlin: Merve, 2011.

Daston, Lorraine. "Inteligencje : anielska, zwierzęca, ludzka." *Contexts (Konteksty)* (1 2011): 163–174.

Daston, Lorraine. "Observation." In *Prints and the pursuit of knowledge in early modern Europe*, ed. Susan Dackerman. 126–133. Cambridge, Mass.: Harvard Art Museums, 2011.

Daston, Lorraine. *Observation as a way of life : time, attention, allegory ; the Hans Rausing lecture 2010 Uppsala University*. *Salvia småskrifter ; 13*. Uppsala: Universitet, 2011.

Daston, Lorraine. "Projection and perfect passivity." In *Affektive Dinge : Objektberührungen in Wissenschaft und Kunst*, eds. Natascha Adamowsky, Robert Felfe, Marco Formisano, Georg Toepfer, and Kirsten Wagner. 24–50. Göttingen: Wallstein, 2011.



Daston, Lorraine. “Die Chimäre.” In *Zoologicon : ein kulturhistorisches Wörterbuch der Tiere*, eds. Christian Kassung, Jasmin Mersmann, and Olaf B. Rader. 78–82. Paderborn: Fink, 2012.

Daston, Lorraine. “Die Glasblumen von Cambridge.” In *Regula Dettwiler – It’s my Nature*, ed. Andrea Jahn. 69–72. Freiburg/Br.: modo Verlag, 2012.

Daston, Lorraine. “The glass flowers.” In *Regula Dettwiler – It’s my Nature*, ed. Andrea Jahn. 73–75. Freiburg/Br.: modo Verlag, 2012.

Daston, Lorraine. “The sciences of the archive.” *Osiris* 27 (1 2012): 156–187.

Daston, Lorraine. “When was modernity, and why do we care?” In *The Moderns : wie sich das 20. Jahrhundert in Kunst und Wissenschaft erfunden hat*, 143–159. Wien [u. a.]: Springer, 2012.

Daston, Lorraine. “Why not just one more rule?” In *Über das Kolleg hinaus : Joachim Nettelbeck, dem Sekretär des Wissenschaftskollegs 1981 bis 2012*, eds. Mamadou Diawara, Klaus Günther, and Reinhart Meyer-Kalkus. 61–64. Berlin: Wissenschaftskolleg zu Berlin, 2012.

1 Daston, Lorraine and Peter Galison. *Objectivité*. Translated by Sophie Renaut and Hélène Quiniou. Fabula, [Dijon]: Les Presses du réel, 2012.

2 Daston, Lorraine and Elizabeth Lunbeck, eds. *Histories of scientific observation*. Chicago: University of Chicago Press, 2011.

Daston, Lorraine and Elizabeth Lunbeck. “Introduction: Observation observed.” In *Histories of scientific observation*, eds. Lorraine Daston and Elizabeth Lunbeck. 1–9. Chicago: University of Chicago Press, 2011.

Daston, Lorraine, Arend Oetker, and Helmut Schwarz. “Geht es wirklich nur ums Geld? [Interview].” *Humboldt-Kosmos* (98 2011): 30-35: <http://www.humboldt-foundation.de/web/kosmos-download-en.html>

De Ceglia, Francesco Paolo. “‘It’s not true, but I believe it’ : discussions on ‘jettatura’ in Naples between the end of the 18th and beginning of the 19th centuries.” *Journal of the History of Ideas* 72 (1 2011): 75–97.

De Ceglia, Francesco Paolo. “[Entry] Monticelli, Teodoro.” In *Dizionario biografico degli italiani*. Vol. 76, 324–327. Roma: Istituto della Enciclopedia italiana, 2012.

De Ceglia, Francesco Paolo. “The science of Santa Claus : discussions on the Manna of Nicholas of Myra in the modern age.” *Nuncius* 27 (2 2012): 241–269.

De Ceglia, Francesco Paolo and Irina Podgorny, eds. *Immortal Bodies*. Nuncius ; 27/2. Special journal issue. Leiden [u.a.]: Brill, 2012.

De Ceglia, Francesco Paolo and Irina Podgorny. “Introduction: Immortal Bodies.” *Nuncius* 27 (2 2012): 235–240.

- 3 De Risi, Vincenzo, ed. *Saccheri, Gerolamo: Euclide vendicato da ogni neo*. Mathematica ; 1. Pisa: Ed. della Normale, 2011.

De Risi, Vincenzo. “Leibniz on relativity : the debate between Hans Reichenbach and Dietrich Mahnke on Leibniz’s theory of motion and time.” In *New essays on Leibniz reception : in science and philosophy of science 1800–2000*, eds. Ralf Krömer and Yannick Chin-Drian. 143–185. Basel: Birkhäuser, 2012.

De Risi, Vincenzo. “Plotino e la rivoluzione scientifica : la presenza delle ‘Enneadi’ nell’epistemologia leibniziana dello spazio fenomenico.” In *Il platonismo e le scienze*, ed. Chiaradonna Riccardo. 143–163. Roma: Carocci, 2012.

De Weerdt, Hilde *see also Chia and De Weerdt*

De Weerdt, Hilde. “Bei Mei de Songdai yanjiu 北美的宋代研究.” In *Bei Mei Zhongguo xue : yan jiu gai shu yu wen xian zi yuan 北美中国学 : 研究概述与文献资源*, eds. Haihui Zhang, Zhaohui Xue, and Shuyong Jiang. 111–144. Beijing: Zhonghua shu ju, 2010.

De Weerdt, Hilde. “Neo-Confucian philosophy and genre : the philosophical writings of Chen Chun and Zhen Dexiu.” In *Dao companion to neo-Confucian philosophy*, ed. John Makeham. 223–248. Dordrecht [u. a.]: Springer, 2010.

De Weerdt, Hilde. “The cultural logics of map reading : text, time and space in printed maps of the Song empire.” In *Knowledge and text production in an age of print : China, 900–1400*, eds. Lucille Chia and Hilde De Weerdt. 239–270. Leiden [u. a.]: Brill, 2011.

Debase, Didier. “Alfred North Whitehead – Le sujets possessifs.” In *Philosophies des possessions*, 233–251. Dijon: Presses du réel, 2011.

Debase, Didier. “Cerveaux.” In *Eine Naturgeschichte für das 21. Jahrhundert : hommage à, zu Ehren von, in honor of Hans-Jörg Rheinberger*, 22–23. Berlin: Max-Planck-Institut für Wissenschaftsgeschichte, 2011.

- 1 Debaise, Didier, ed. *Philosophies des possessions*. Relecture-anthologies. Dijon: Presses du réel, 2011.

Demeter, Tamás *see also Zemplén and Demeter*

Demeter, Tamás. "In defence of empty realism." *Journal for General Philosophy of Science* 41 (1 2010): 195–197.

Demeter, Tamás. "Psychology is not a metarepresentational device." *European Journal of Analytic Philosophy* 5 (2 2010): 19–38.

Demeter, Tamás. "The search for an image of man." *Studies in East European Thought* 62 (2 2010): 155–167.

Demeter, Tamás. "A touch of the dramatic." In *Sherlock Holmes and philosophy : the footprints of a gigantic mind*, ed. Josef Steiff. 197–208. Chicago [u. a.]: Open Court, 2011.

Demeter, Tamás. "Wine." In *Eine Naturgeschichte für das 21. Jahrhundert : hommage à, zu Ehren von, in honor of Hans-Jörg Rheinberger*, 170–171. Berlin: Max-Planck-Institut für Wissenschaftsgeschichte, 2011.

Demeter, Tamás. "The anatomy and physiology of mind : David Hume's vitalistic account." In *Blood, sweat and tears : the changing concepts of physiology from antiquity into early modern Europe*, eds. Manfred Horstmanshoff, Helen King, and Claus Zittel. 217–240. Leiden [u. a.]: Brill, 2012.

Demeter, Tamás. "Hume's experimental method." *British Journal for the History of Philosophy* 20 (3 2012): 577–599.

Demeter, Tamás. "Liberty, necessity and the foundations of Hume's 'Science of Man'" *History of the Human Sciences* 25 (1 2012): 15–31.

Demeter, Tamás. "Weltanschauung as a priori : sociology of knowledge from a 'romantic' stance." *Studies in East European Thought* 64 (1–2 2012): 39–52.

- 2 DeWitt, Cécile M. and Dean Rickles, eds. *The role of gravitation in physics : report from the 1957 Chapel Hill Conference*. Max Planck Research Library for the history and development of knowledge, sources ; 5. Berlin: epubli GmbH, 2011: <http://edition-open-access.de/sources/5/index.html>

Dias, Nélia. "Exploring the senses and exploiting the land : railroads, bodies and measurement in nineteenth-century French colonies." In *Material powers : cultural studies, history and the material turn*, eds. Tony Bennett and Patrick Joyce. 171–189. London [u. a.]: Routledge, 2010.



Dobrin, Lise M. and Josh Berson. “Speakers and language documentation.”

In *The Cambridge handbook of endangered languages*, eds. Peter K. Austin and Julia Sallabank. 187–211. Cambridge [u. a.]: Cambridge University Press, 2011.

- 3** Dongen, Jeroen van. *Einstein's unification*. Cambridge [u. a.]: Cambridge University Press, 2010.

Dupré, Sven *see also* Clarke, De Munck and Dupré

Dupré, Sven *see also* Morrison-Low and Dupré

Dupré, Sven. “The historiography of perspective and reflexy-const in netherlandish art.” *Nederlands Kunsthistorisch Jaarboek* 61 (2011): 35–60.

Dupré, Sven. “Trading luxury glass, picturing collections and consuming objects of knowledge in early seventeenth-century Antwerp.” In *Silent messengers : the circulation of material objects of knowledge in the Early Modern Low Countries*, 261–291. Berlin [u. a.]: LIT Verlag, 2011.

Dupré, Sven. “Introduction: Writing the history of the telescope : makers, markets and mapping.” In *From earth-bound to satellite : telescopes, skills and networks*, eds. Alison D. Morrison-Low, Sven Dupré, Stephen Johnston, and Giorgio Strano. XXIX–XXIX. Leiden [u. a.]: Brill, 2012.

Dupré, Sven. “Kepler’s optics without hypotheses.” *Synthese* 185 (3 2012): 501–525.

Dupré, Sven. “Wissen in der Werkstatt des Künstlers. Knowledge in the Artist’s Workshop.” *Jahrbuch der Max-Planck-Gesellschaft* (2012): 661–667.

- 4** Dupré, Sven and Christoph Lüthy, eds. *Silent messengers : the circulation of material objects of knowledge in the Early Modern Low Countries*. Low Countries studies on the circulation of natural knowledge ; 1. Berlin [u. a.]: LIT Verlag, 2011.

Dupré, Sven and Christoph Lüthy. “Introduction: Silent messengers : the world of goods and the circulation of knowledge in the early modern Netherlands.” In *Silent messengers : the circulation of material objects of knowledge in the Early Modern Low Countries*, 1–12. Berlin [u. a.]: LIT Verlag, 2011.



Ebeling, Werner and Dieter Hoffmann. “Max Plancks Beiträge zur Thermodynamik.” *Sitzungsberichte der Leibniz-Sozietät der Wissenschaften zu Berlin* 105 (2010): 73–84.

- 1 Elazar, Michael. *Honoré Fabri and the concept of impetus : a bridge between conceptual frameworks*. Boston studies in the philosophy of science ; 288. Dordrecht [u. a.]: Springer, 2011.

Elazar, Michael. “A dispute over superposition : John Wallis, Honoré Fabri, and Giovanni Alfonso Borelli.” *Annals of Science* (2012): 1–21.

- 2 Elkana, Yehuda and Hannes Klöpfer. *Die Universität im 21. Jahrhundert : für eine neue Einheit von Lehre, Forschung und Gesellschaft*. Hamburg: Edition Körber-Stiftung, 2012.

Elkana, Yehuda, Manfred Dietrich Laubichler, and Adam S. Wilkins. “Call to reshape university curricula.” *Nature* 467 (7317 2010): 788–788.

Engler, Fynn Ole *see also* Lemke, Breidenmoser, Drack and Engler

Engler, Fynn Ole. “Koinzidenzen, Gestalten und Denkstile : Moritz Schlick und Ludwik Fleck über die Objektivität am Fundament der Erkenntnis und die Bedeutung der Wissenschaftsgeschichte.” In *Moritz Schlick : Ursprünge und Entwicklungen seines Denkens*, eds. Fynn Ole Engler and Mathias Iven. 339–386. Berlin: Parerga, 2010.

Engler, Fynn Ole. “Kritischer Rationalismus.” In *Wissenschaftstheorie*, eds. Detlef Horster and Wolfgang Jantzen. 214–218. Stuttgart: Kohlhammer, 2010.

Engler, Fynn Ole. “Revolutionen oder stetiger Wandel? Auf den Spuren der Wissenschaftsphilosophie Max Borns.” *Physik Journal* 9 (3 2010): 50–53.

Engler, Fynn Ole. “Denk-Standpunkte.” In *Vérité, Widerstand, Development : at work with / arbeiten mit / travailler avec Ludwik Fleck*, eds. Rainer Egloff and Johannes Fehr. 21–37. Zürich: Collegium Helveticum, 2011.

- 3 Engler, Fynn Ole and Mathias Iven, eds. *Moritz Schlick : Ursprünge und Entwicklungen seines Denkens*. Schlickiana ; 5. Berlin: Parerga, 2010.



6

Engler, Fynn Ole and Mathias Iven. “Moritz Schlick (1882–1936) : Philosoph und Physiker.” In *Rostocker gelehrte Köpfe*, eds. Gisela Boeck and Hans-Uwe Lammel. 33–53. Rostock: Universität, 2012: http://rosdok.uni-rostock.de/file/rosdok_derivate_000000004972/Studien20.pdf

Engler, Fynn Ole and Jürgen Renn. “Krumme Wege der Vernunft : Wissenschaft hat eine Geschichte, wie kann sie da rational sein? Im Briefwechsel zwischen Fleck und Moritz Schlick deuten sich Antworten an.” *Frankfurter Allgemeine Sonntagszeitung*, 05.06.2011, 62/65.

Epple, Moritz, Mikael Hård, Sybilla Nikolow, Hans-Jörg Rheinberger, and Volker Roelcke. “50 Jahre NTM.” *NTM* 18 (3 2010): 269–274.

Epple, Moritz and Karin Krauthausen. “Zur Notation topologischer Objekte : Interview mit Moritz Epple.” In *Notieren, Skizzieren : Schreiben und Zeichnen als Verfahren des Entwurfs*, eds. Karin Krauthausen and Omar W. Nasim. 119–138. Zürich [u. a.]: Diaphanes, 2010.

Espmark, Kristina and Christer Nordlund. “Married for science, divorced for love : success and failure in the collaboration between Astrid Cleve and Hans von Euler-Chelpin.” In *For better or for worse? Collaborative couples in the sciences*, eds. Annette Lykknes, Donald L. Opitz, and Brigitte van Tiggelen. 81–102. Basel [u. a.]: Birkhäuser, 2012.

Feest, Uljana *see also Sturm and Feest*

- 4 Feest, Uljana, ed. *Historical perspectives on Erklären und Verstehen*. Archimedes ; 21. Dordrecht [u. a.]: Springer, 2010.

Feldhay, Rivka. “Wissenschaft in kleinen und großen Ländern.” *Nach Feierabend : Zürcher Jahrbuch für Wissensgeschichte* 6 (2010): 181–190.

- 5 Feng, Jiren. *Chinese architecture and metaphor : Song culture in the Yingzao Fashi building manual*. Spatial Habitus. Honolulu [u. a.]: University of Hawaii Press, 2012.

- 6 Fengler, Silke and Carola Sachse. *Kernforschung in Österreich : Wandlungen eines interdisziplinären Forschungsfeldes 1900–1978*. Wissenschaft, Macht und Kultur in der modernen Geschichte ; 1. Wien [u. a.] : Böhlau, 2012.

Fernández, Isabel, José M. Pacheco, and María P. Quintana. "Pinkness of the North Atlantic Oscillation signal revisited." *Physica A* 389 (24 2010): 5801–5807.

Fiorentini, Erna. "Konvergent / Divergent : ein historischer Blick auf den Dialog von Kunst und Wissenschaft." In *Dopplereffekt : Bilder in Kunst und Wissenschaft*, eds. Petra Gördüren and Dirk Luckow. 95–102. Köln: Dumont, 2010.

Fiorentini, Erna. "Landschaftszeichnung und Ortssehnsucht um 1800." In *Räume des Subjekts um 1800 : zur imaginativen Selbstverortung des Individuums zwischen Spätaufklärung und Romantik*, eds. Jörn Steigerwald and Rudolf Behrens. 245–264. Wiesbaden: Harrassowitz, 2010.

Fiorentini, Erna. "Inducing visibilities : an attempt at Santiago Ramón y Cajal's aesthetic epistemology." *Studies in History and Philosophy of Biological and Biomedical Sciences* 42 (4 2011): 391–394.

- 1 Fischer, Ernst Peter, Jürgen Renn, and Horst Ziegelmann. *Albert Einstein : Helden ohne Degen*. Berlin: Be.bra Wissenschaft, 2012.

Fjæstad, Maja. "Arga amatörer ville stoppa Einsteins teori." *Svenska Dagbladet*, 10. 06. 2010: http://www.svd.se/kultur/understreckat/arga-amatorer-ville-stoppa-einsteins-teori_4841011.svd

Fjæstad, Maja. "Teknikval är avgörande för kärnkraftens framtid." *DN Debatt*, 03. 06. 2010.

- 2 Fjæstad, Maja. *Visionen om outtömlig energi : brytreaktorn i svensk kärnkraftshistoria 1945–80*. Stockholms papers in the history of philosophy and technology : TRITA-HOT ; 2062. Hedemora: Gidlunds Förlag, 2010.

Fjæstad, Maja and Thomas Jonter. "Between welfare and warfare : the rise and fall of the 'Swedish Line' in nuclear engineering." In *Science for welfare and warfare : technology and state initiative in cold war Sweden*, eds. Per Lundin, Niklas Stenlås, and Johan Gribbe. 153–172. Sagamore Beach, MA: Science History Publ., 2010.

Freire, Olival and Christoph Lehner. "Dialectical materialism and modern physics,' an unpublished text by Max Born." *Notes and Records of the Royal Society of London* 64 (2 2010): 155–162.

Freyberg, Sascha. "[Entries] 'Monade', 'Musik', 'Nomade', 'Struktur.'" In *Lexikon der Raumphilosophie*, ed. Stephan Günzel. Darmstadt: Wiss. Buchgesellschaft, 2012.

Fricke, Lutz and Suparna Choudhury. "Neuropolitik und plastische Gehirne : eine Fallstudie des adoleszenten Gehirns." *Deutsche Zeitschrift für Philosophie* 59 (3 2011): 391–402.



Friedman, Judith E. “Anticipation in hereditary disease : the history of a biomedical concept.” *Human Genetics* 130 (6 2011): 705–714.

Friedman, Michael. “Newton and Kant : quantity of matter in the ‘Metaphysical Foundations of Natural Science’” *Southern Journal of Philosophy* 50 (2012): 482–503.

Friedman, Michael. “The ‘Prolegomena’ and natural science.” In *Kants Prolegomena : ein kooperativer Kommentar*, eds. Holger Lyre and Oliver Schliemann. 299–326. Frankfurt am Main: Klostermann, 2012.

Friedman, Michael. “Reconsidering the dynamics of reason : response to Ferrari, Mormann, Nordmann, and Uebel.” *Studies in History and Philosophy of Science* 43 (1 2012): 47–53.

Friedrich, Bretislav and Dieter Hoffmann. “Sto let fyzikalne-chemickeho vyzkumu v Berline-Dahlemu : ustav Fritze Habera v letech 1911–2011.” *Ceskoslovensky casopis pro fyziku* 62 (2 2012): 110–124.

Friedrich, Bretislav, Dieter Hoffmann, and Jeremiah James. “One hundred years of the Fritz Haber Institute.” *Angewandte Chemie : International edition* 50 (43 2012): 10022–10049.

Gabriel, Miriam. “Tiermaschinen und Maschinentiere.” In *Wunderforschung : ein Experiment von Kindern, Wissenschaftlern und Künstlern*, eds. Katja Bödeker and Carmen Hammer. 83–91. Berlin: Nicolai, 2010.

- 3** Gantet, Claire. *Der Traum in der Frühen Neuzeit : Ansätze zu einer kulturellen Wissenschaftsgeschichte*. Frühe Neuzeit ; 143. Berlin [u. a.]: de Gruyter, 2010.

Gausemeier, Bernd *see also* Azzouni, Brandt and Gausemeier

Gausemeier, Bernd. “Genetics as a modernization program : biological research at the Kaiser Wilhelm Institutes and the political economy of the Nazi state.” *Historical Studies in the Natural Sciences* 40 (4 2010): 429–456.

Gausemeier, Bernd. “Mondmenschen.” In *Eine Naturgeschichte für das 21. Jahrhundert : hommage à, zu Ehren von, in honor of Hans-Jörg Rheinberger*, 198–200. Berlin: Max-Planck-Institut für Wissenschaftsgeschichte, 2011.



- 1 Gavroglu, Kostas and Ana Simões. *Neither physics nor chemistry : a history of quantum chemistry*. Transformations : studies in the history of science and technology. Cambridge, Mass.: MIT Press, 2012.

Geller, Florentina Badalanova. “Gynesis’ in Genesis.” In *Forma formans : studi in onore di Boris Uspenskij. Vol. 1*, eds. Sergio Bertolissi and Roberta Salvatore. 17–48. Napoli: D’Auria editore, 2010.

Geller, Florentina Badalanova. “The sea of Tiberias : between apocryphal literature and oral tradition.” In *The old testament apocrypha in the Slavonic tradition : continuity and diversity*, eds. Lorenzo DiTommaso and Christfried Böttrich. 13–157. Tübingen: Mohr-Siebeck, 2011.

- 2 Geller, Markham J. *Ancient Babylonian medicine : theory and practice*. Ancient cultures. Chichester [u. a.]: Wiley-Blackwell, 2010.

Geller, Markham J. “(in Hebrew) ‘Black Magic’ מאגיה שחורה and ‘Lilith’ לילית.” In *Angels and demons : jewish magic through the ages*, ed. Filip Vukosavovic. 34–35, 88–89. 2nd ed. Jerusalem: Bible Lands Museum, 2010.

Geller, Markham J. “Late Babylonian Lugale.” In *Your praise is sweet – a memorial volume for Jeremy Black from students, colleagues and friends*, eds. Heather D. Baker, Eleanor Robson, and Gábor Zólyomi. 93–100. London: British Inst. for the Study of Iraq, 2010.

Geller, Markham J. “Skin disease and the doctor.” *Le journal des médecines cunéiformes* 15 (2010): 40–56.

Geller, Markham J. “Die theoretische Grundlage der babylonischen Heilkunde.” In *Babylon : Wissenskultur in Orient und Okzident*, eds. Eva Cancik-Kirschbaum, Margarethe van Ess, and Joachim Marzahn. 153–157. Berlin [u. a.]: de Gruyter, 2010.

Geller, Markham J. “Divination or medicine?” In *U4 du11-ga-ni sa mu-ni-ib-du11 : ancient Near Eastern studies in memory of Blahoslav Hruška*, ed. Luděk Vacín. 91–95. Dresden: ISLET-Verlag, 2011.

Gerritsen, Anne. “Ceramics for local and global markets : Jingdezhen’s Agora.” In *Cultures of knowledge : technology in Chinese history*, ed. Dagmar Schäfer. 161–184. Leiden [u. a.]: Brill, 2012.

Gerritsen, Anne and Wim Gerritsen. “Hong Yanzu in Jingdezhen : twee 14e-eeuwse gedichten over keramiek.” *Aziatische Kunst* 40 (1 2010): 25–31.

- 3 Gindhart, Marion and Ursula Kundert, eds. *Disputatio 1200–1800 : Form, Funktion und Wirkung eines Leitmediums universitärer Wissenskultur*. Trends in medieval philology ; 20. Berlin [u. a.]: de Gruyter, 2010.

Görz, Günther. “Alexander unterwegs in Ebstorf und anderswo : ein Versuch zu kognitiven Karten, ihrer epistemologischen Rekonstruktion und logischen Implementierung.” In *Projektion – Reflexion – Ferne : räumliche Vorstellungen und Denkfiguren im Mittelalter*, eds. Sonja Glauch, Susanne Köbele, and Uta Störmer-Caysa. 347–368. Berlin [u. a.]: de Gruyter, 2011.

Görz, Günther. “KI und Geisteswissenschaften.” *Künstliche Intelligenz : KI* 25 (4 2011): 313–315.

Görz, Günther. “Semantische Annotation, Wissensverarbeitung und Wissenschaftskommunikation in einer virtuellen Forschungsumgebung.” *Kunstgeschichte. Open Peer Reviewed Journal* (2011): 1–17: <http://www.kunstgeschichte-ejournal.net/167/>

Goffi, Jean-Yves and Sophie Roux. “On the very idea of a thought experiment.” In *Thought experiments in historical and methodological contexts*, eds. Katerina Ierodiakonou and Sophie Roux. 165–191. Leiden [u. a.]: Brill, 2011.

Goldstein, Bernard R. and Giora Hon. “Duhem’s continuity thesis : the intrusion of ideology into history of science.” In *Studies in the history of culture and science : a tribute to Gad Freudenthal*, eds. Resianne Fontaine, Ruth Glasner, Reimund Leicht, and Giuseppe Veltri. 385–410. Leiden [u. a.]: Brill, 2011.

Gordin, Michael D. “Seeing is believing : Professor Vagner’s wonderful world.” In *Histories of scientific observation*, eds. Lorraine Daston and Elizabeth Lunbeck. 135–155. Chicago: University of Chicago Press, 2011.

Gorelick, Root, Manfred Dietrich Laubichler, and Rachel Massicotte. “Asexuality and epigenetic variation.” In *Epigenetics : linking genotype and phenotype in development and evolution*, eds. Benedikt Hallgrímsson and Brian K. Hall. 87–102. Berkeley [u. a.]: University of California Press, 2011.

Gosewinkel, Dieter, Peter Schöttler, and Iris Schröder, eds. *Antiliberales Europa*. Zeithistorische Forschungen ; 9/3. Göttingen: Vandenhoeck & Ruprecht, 2012.

Grote, Mathias. "Surfaces of action : cells and membranes in electrochemistry and the life sciences." *Studies in History and Philosophy of Biological and Biomedical Sciences* 41 (3 2010): 183–193.

Grote, Mathias. "Jeewanu." In *Eine Naturgeschichte für das 21. Jahrhundert : hommage à, zu Ehren von, in honor of Hans-Jörg Rheinberger*, 222–224. Berlin: Max-Planck-Institut für Wissenschaftsgeschichte, 2011.

Grote, Mathias. "Jeewanu, or the 'particles of life' : the approach of Krishna Bahadur in 20th century origin of life research." *Journal of Biosciences* 36 (4 2011): 563–570.

Grote, Mathias and Maureen O'Malley. "Enlightening the lifesciences : the history of halobacterial and microbial rhodopsin research." *FEMS Microbiology Reviews* 35 (6 2011): 1082–1099.

Grünberg, Angela. "Saying and doing : speech actions, speech acts and related events." *European Journal of Philosophy* 19 (2011): 1–36.

Güttler, Nils R. "Der 'Botanochartograph' : Oscar Drude und der Perthes Verlag." In *Die Werkstatt des Kartographen : Materialien und Praktiken visueller Welt-erzeugung*, eds. Steffen Siegel and Petra Weigel. 161–184. München: Fink, 2011.

Güttler, Nils R. "Scaling the period eye : Oscar Drude and the cartographical practice of plant geography 1870s–1910s." *Science in Context* 24 (1 2011): 1–41.

Güttler, Nils R. "Lebensraum : frühe pflanzengeographische Karten und die 'natürliche Ökonomie' der Gewächse." In *Raum, Wissen, Medien : zur raumtheoretischen Reformulierung des Medienbegriffs*, eds. Dorit Müller and Sebastian Scholz. 39–58. Bielefeld: Transcript, 2012.

Guillem-Llobat, Ximo. "Food safety, the rural/urban dichotomy and Valencian society 1850–1930." In *Making a new countryside : health policies and practices in European history ca. 1860–1950*, eds. Astri Andresen, Joseph L. Barona, and Steven Cherry. 135–145. Frankfurt/M. [u. a.]: Lang, 2010.

Hammer, Carmen *see also Bödeker and Hammer*

Hammer, Carmen. "Soll ich dir ein Wunder erzählen?" In *Wunderforschung : ein Experiment von Kindern, Wissenschaftlern und Künstlern*, eds. Katja Bödeker and Carmen Hammer. 124–129. Berlin: Nicolai, 2010.

Harwood, Jonathan. "The fate of peasant-friendly plant-breeding in Nazi Germany." *Historical Studies in the Natural Sciences* 40 (4 2010): 570–604.

Harwood, Jonathan. "Universalsorten." In *Eine Naturgeschichte für das 21. Jahrhundert : hommage à, zu Ehren von, in honor of Hans-Jörg Rheinberger*, 70–71. Berlin: Max-Planck-Institut für Wissenschaftsgeschichte, 2011.



1 Harwood, Jonathan. *Europe's green revolution and others since : the rise and fall of peasant-friendly plant breeding*. Routledge explorations in economic history ; 56. London [u. a.]: Routledge, 2012.

2 Hasler, Felix. *Neuromythologie : eine Streitschrift gegen die Deutungsmacht der Hirnforschung*. X Texte. Bielefeld: Transcript, 2012.

Hau, Michael. "Asceticism and pleasure in German health reform : patients as clients in Wilhelmine Sanatoria." In *Beyond pleasure : cultures of modern asceticism*, eds. Evert Peeters, Leen van Molle, and Kaat Wils. 42–61. New York [u. a.]: Berghahn Books, 2011.

3 Hauschild, Thomas, Britta Heinrich, Jörg Potthast, and Viktoria Tkaczyk, eds. *Von Vogelmenschen, Piloten und Schamanen : Kulturgeschichte und Technologien des Fliegens*. Dresden: Ed. Azur, 2011.

Hoffmann, Christoph. "Schreiben als Verfahren der Forschung." In *Experiment und Literatur : Themen, Methoden, Theorien*, ed. Michael Gamper. 181–207. Göttingen: Wallstein, 2010.

Hoffmann, Christoph. "Umgebungen : über Ort und Materialität von Ernst Machs Notizbüchern." In *Portable Media : Schreibszenen in Bewegung zwischen Peripatetik und Mobiltelefon*, eds. Martin Stingelin and Matthias Thiele. 89–107. München: Fink, 2010.

Hoffmann, Christoph. "Augen und Blicke : Robert Musils Tierbilder." In *Medien, Technik, Wissenschaft : Wissensübertragung bei Robert Musil und in seiner Zeit*, eds. Ulrich Johannes Beil, Michael Gamper, and Karl Wagner. 209–218. Zürich: Chronos, 2011.

Hoffmann, Christoph. "Drei Geschichten : Erzählen als experimentelle Operation bei Musil (und Kleist)." In *'Es ist ein Laboratorium, ein Laboratorium für Worte' : 1890–2010*, eds. Michael Bies and Michael Gamper. 162–180. Göttingen: Wallstein, 2011.

Hoffmann, Christoph. "Eigenleben im Experiment : zur Erforschung 'natürlicher' Systeme." In *Videogramme : die Bildwelten biologischer Experimentalsysteme als*



1

Kunst- und Theorieobjekt, ed. Hannes Rickli. 46–55. Zürich: Scheidegger & Spiess, 2011.

Hoffmann, Christoph. “Forschen mit Bildern.” In *Videogramme : die Bildwelten biologischer Experimentalsysteme als Kunst- und Theorieobjekt*, ed. Hannes Rickli. 66–68. Zürich: Scheidegger & Spiess, 2011.

Hoffmann, Christoph. “Pisum sativum.” In *Eine Naturgeschichte für das 21. Jahrhundert : hommage à, zu Ehren von, in honor of Hans-Jörg Rheinberger*, 58–59. Berlin: Max-Planck-Institut für Wissenschaftsgeschichte, 2011.

Hoffmann, Christoph. “Bilderschwind : Forschen mit optischen Datenquellen.” In *Machtwechsel der Bilder : Bild und Bildverstehen im Wandel*, eds. Enno Rudolph and Thomas Steinfeld. 143–160. Zürich: Orell Füssli, 2012.

Hoffmann, Christoph and Lidia Westermann. “‘Literatur-Auszüge’ : Gottfried Benn als Referent der ‘Berliner Klinischen Wochenschrift’.” *Zeitschrift für Germanistik* 20 (3 2010): 636–648.

Hoffmann, Dieter *see also* Beyer, Eckert and Hoffmann

Hoffmann, Dieter *see also* Ebeling and Hoffmann

Hoffmann, Dieter *see also* Friedrich and Hoffmann

Hoffmann, Dieter *see also* Marx and Hoffmann

Hoffmann, Dieter *see also* Müller-Enbergs, Wielgoths and Hoffmann

Hoffmann, Dieter *see also* Steinhauser, James and Hoffmann

Hoffmann, Dieter. “Aufstieg und Niedergang der ‘Großen Berliner Physik’.” In *Transformation der Wissensordnung*, ed. Heinz-Elmar Tenorth. 549–573. Berlin: Akademie Verlag, 2010.

1 Hoffmann, Dieter, ed. *Max Planck und die moderne Physik*. Berlin: Springer, 2010.

Hoffmann, Dieter. "Max Planck in seinem Wirken für die Physikalische Gesellschaft und die 'Annalen der Physik'" In *Max Planck und die moderne Physik*, ed. Dieter Hoffmann. 1–34. Berlin: Springer, 2010.

Hoffmann, Dieter. "Max Planck và Albert Einstein, đồng nghiệp trong sự dị biệt." In *Max Planck – Người khai sáng thuyết lượng tử – Kỳ yêu mừng sinh nhật thu 150 (1858–2008)*, eds. Phạm Xuân Yem and Nguyễn Xuân Xanh. 107–122. Ho Chi Minh City: Nhà Xuất Bản Tri Thức, 2010.

Hoffmann, Dieter. "‘Nicht nur ein Kopf, sondern auch ein Kerl!’ : zum Leben und Wirken Max von Laues (1879–1960)." *Physik-Journal* 9 (5 2010): 39–43.

Hoffmann, Dieter. "Paul Drude (1863–1906)." In *1st EHoP Conference Graz, Austria, Sept. 18–21, 2006 : proceedings of the First European History of Physics (EHoP) Conference of the History of Physics Section of the Austrian Physical Society (OEPG) in conjunction with the History of Physics Group of the European Physical Society (EPS) and the History of Physics Group of the Institute of Physics (IOP)*, eds. Peter Maria Schuster and Denis Weaire. 50–58. Pöllauberg [u. a.]: Living Edition, 2010.

Hoffmann, Dieter. "Physikalische Forschung im Spannungsfeld von Wissenschaft und Politik." In *Selbstbehauptung einer Vision*, ed. Heinz-Elmar Tenorth. 551–581. Berlin: Akademie Verlag, 2010.

Hoffmann, Dieter. "[Entry] 'Seeliger, Rudolf'" In *Neue Deutsche Biographie. Bd. 24*, Historische Kommission der Bayerischen Akademie der Wissenschaften. 150–151. 4. ed. Berlin: Duncker & Humblot, 2010.

Hoffmann, Dieter. "Der Einstein-Verein : vor 100 Jahren wurde die Kaiser-Wilhelm-Gesellschaft als Ort der Spitzenforschung gegründet." *Der Tagesspiegel*, 10.01. 2011, 18.

Hoffmann, Dieter. "Keine Begeisterung beim Hitlergruß." *Frankfurter Allgemeine Sonntagszeitung*, 31.07. 2011, 52.

Hoffmann, Dieter. "Physiker im Krieg : [zwei Briefeditionen]." *Der Tagesspiegel*, 07.02. 2011, 24.

Hoffmann, Dieter. "Physiker und Pianist." *Der Tagesspiegel*, 21.09. 2011, 24.

Hoffmann, Dieter. "Die Sterne über Berlin : zum 150. Geburtstag von Friedrich Archenhold." *Der Tagesspiegel*, 06. 10. 2011, 29.

Hoffmann, Dieter. "Wer nicht das Gleiche glaubt, ist auszurotten." *Frankfurter Allgemeine Zeitung*, 16. 11. 2011, N3.

Hoffmann, Dieter. "Carl Ramsauer (1879–1955) : fizyk na rozdrożu między nauką, przemysłem a polityką." *Pismo PG XIII* (10 2012): 60–65:
http://www.pg.gda.pl/pismo/?y=2010&n=10&f=cz_1.pdf

Hoffmann, Dieter. "Der Fall Einstein." *PTB-Mitteilungen* 122 (2 2012): 22–23.

Hoffmann, Dieter. "Die Kunst des Messens." *Der Tagesspiegel*, 15. 10. 2012, 22.

Hoffmann, Dieter. "Neues zum Verhältnis von Werner Heisenberg und Carl Friedrich von Weizsäcker." *Schweizerische Physikalische Gesellschaft (SPG) / Mitteilungen* 36 (1 2012): 19–20:
<http://www.sps.ch/uploads/media/Mitteilungen.36.pdf>

Hoffmann, Dieter. "Pascual Jordan (1902–1980) : der gute Nazi." In *Die Universität Rostock in den Jahren 1933–1945 : Referate der interdisziplinären Ringvorlesung des Arbeitskreises „Rostocker Universitäts- und Wissenschaftsgeschichte“ im Sommersemester 2011*, eds. Gisela Boeck and Hans-Uwe Lammel. 131–161. Rostock: Universität, 2012:
http://rosdok.uni-rostock.de/resolve?id=rosdok_document_00000000223

Hoffmann, Dieter. "Die Physikalisch-Technische Reichsanstalt im Dritten Reich." *PTB-Mitteilungen* 122 (2 2012): 30–31.

Hoffmann, Dieter. "Physiker, Kommunist, Atomspion : die drei Leben des Klaus Fuchs (1911–1988)." *Physik-Journal* 11 (2 2012): 39–43.

Hoffmann, Dieter. "PTR, PTA und DAMG : die Nachkriegszeit." *PTB-Mitteilungen* 122 (2 2012): 34–35.

Hoffmann, Dieter. "The Ramsauer era and self-mobilization of the German Physical Society." In *The German Physical Society and the Third Reich : physicists between autonomy and accommodation*, eds. Dieter Hoffmann and Mark Walker. 126–168. New York: Cambridge University Press, 2012.

Hoffmann, Dieter. "Werner Kolhörster : Pionier der Höhenstrahlungsforschung ; hundert Jahre Entdeckung der kosmischen Strahlung." *Physik in unserer Zeit* 43 (6 2012): 281–287.

Hoffmann, Dieter. "Zu den Beziehungen von Carl Friedrich Weizsäcker und Werner Heisenberg." In *Perspektiven und Begegnungen – Carl Friedrich von Weizsäcker zum 100. Geburtstag*, eds. Ulrich Bartosch and Reiner Braun. 138–144. Münster [u. a.]: LIT-Verlag, 2012.

Hoffmann, Dieter and Martin Cernohorsky. "The first disappearance of Mach's Plaque." In *Ernst Mach's Prague 1867–1895 as a human adventure*, eds. John Thomas Blackmore, Ryoichi Itagaki, and Setsuko Tanaka. 431–432. Bethesda, Md.: Sentinel Open Press, 2010.

Hoffmann, Dieter and Christian Joas. "'Then & Now' – a new section dedicated to the history of physics [Editorial]." *Annalen der Physik* 524 (2 2012): A25–A26.

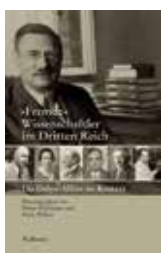

1

2

Hoffmann, Dieter and Hans Koch. “Ein Schmuckkästchen für die Physik : das ‘Observatorium’ der Physikalisch-Technischen Reichsanstalt (PTR), eine Pionierleistung der Wissenschaftsarchitektur, war Vorbild für moderne Forschungsbauten.” *Physik-Journal* 11 (11 2012): 49–51.

Hoffmann, Dieter, Hole Rößler, and Gerald Reuther. “‘Lachkabinett’ und ‘großes Fest’ der Physiker : Walter Grotrians ‘physikalischer Einakter’ zu Max Plancks 80. Geburtstag.” *Berichte zur Wissenschaftsgeschichte* 33 (1 2010): 30–53.

- 1 Hoffmann, Dieter and Mark Walker, eds. *‘Fremde’ Wissenschaftler im Dritten Reich : die Debye-Affäre im Kontext*. Göttingen: Wallstein, 2011.

Hoffmann, Dieter and Mark Walker. “Einleitung : Peter Debye, die Debye-Affäre und andere ‘fremde’ Wissenschaftler im Dritten Reich.” In *‘Fremde’ Wissenschaftler im Dritten Reich : die Debye-Affäre im Kontext*, eds. Dieter Hoffmann and Mark Walker. 11–50. Göttingen: Wallstein, 2011.

- 2 Hoffmann, Dieter and Mark Walker, eds. *The German Physical Society and the Third Reich : physicists between autonomy and accommodation*. New York: Cambridge University Press, 2012.

Hoffmann, Dieter and Nguyen Xuan Xanh. “Max Planck va giai Nobel.” In *Max Planck – Người khai sáng thuyết lượng tử – Kỷ yếu mừng sinh nhật thứ 150 (1858–2008)*, eds. Pham Xuan Yem and Nguyen Xuan Xanh. 123–132. Ho Chi Minh City: Nhà Xuất Bản Tri Thức, 2010.

Hon, Giora *see also Goldstein and Hon*

Hon, Giora *see also Zik and Hon*

Hon, Giora. “Snail.” In *Eine Naturgeschichte für das 21. Jahrhundert : hommage à, zu Ehren von, in honor of Hans-Jörg Rheinberger*, 111–112. Berlin: Max-Planck-Institut für Wissenschaftsgeschichte, 2011.

Hon, Giora and Bernard R. Goldstein. “Maxwell’s contrived analogy : an early version of the methodology of modeling.” *Studies in History and Philosophy of Modern Physics* 43 (4 2012): 236–257.



Hoquet, Thierry. “Cyborg.” In *Eine Naturgeschichte für das 21. Jahrhundert : hommage à, zu Ehren von, in honor of Hans-Jörg Rheinberger, 189–190*. Berlin: Max-Planck-Institut für Wissenschaftsgeschichte, 2011.

- 1 Hyder, David and Hans-Jörg Rheinberger, eds. *Science and the life-world : essays on Husserl's 'Crisis of the European sciences'*. Stanford, Ca.: Stanford University Press, 2010.

Hyman, Ludmila. “The Soviet psychologists and the path to international psychology.” In *The globalization of knowledge in history*, ed. Jürgen Renn. 631–668. Berlin: epubli GmbH, 2012: http://www.edition-open-access.de/studies/1/chapter_29.html

Hyman, Malcolm D. *see also Renn and Hyman*

Hyman, Malcolm D. *see also Scharf and Hyman*

Hyman, Malcolm D. and Jürgen Renn. “Survey: From technology transfer to the origins of science.” In *The globalization of knowledge in history*, ed. Jürgen Renn. 75–104. Berlin: epubli GmbH, 2012: http://www.edition-open-access.de/studies/1/chapter_6.html

Hyman, Malcolm D. and Jürgen Renn. “Toward an Epistemic Web.” In *The globalization of knowledge in history*, ed. Jürgen Renn. 821–838. Berlin: epubli GmbH, 2012: http://www.edition-open-access.de/studies/1/chapter_35.html

Hyman, Malcolm D. and Jürgen Renn. “Toward an Epistemic Web.” *RatSWD Working Paper* (197 2012): 1–22: http://www.ratswd.de/download/RatSWD_WP_2012/RatSWD_WP_197.pdf

Ierodiakonou, Katerina and Sophie Roux, eds. *Thought experiments in methodological and historical contexts. History of science and medicine library ; 19 / Medieval and Early Modern Science ; 15*. Leiden [u. a.]: Brill, 2011.

Jähnert, Martin. “Revisiting the 1927 Solvay conference and the early interpretation of quantum mechanics.’ Essay review of Bacciagaluppi, Guido and Antony Valentini: *Quantum theory at the crossroads : reconsidering the 1927 Solvay conference*. Cambridge: Cambridge University Press 2009.” *Metascience* 21 (1 2012): 125–129.

James, Jeremiah *see also* Friedrich, Hoffmann and James

James, Jeremiah *see also* Steinhauser and James

James, Jeremiah, Friedrich Bretislav, and Thomas Steinhauser. “Das Fritz Haber Institut.” In *Denkorte : Max-Planck-Gesellschaft und Kaiser-Wilhelm-Gesellschaft ; Brüche und Kontinuitäten 1911–2011*, eds. Peter Gruss and Reinhard Rürup. 80–91. Dresden: Sandstein Verlag, 2010.

Janousch, Andreas. “Dinastía Han : historia, historiadores e historiografía.” In *Imágenes para la inmortalidad en la Dinastía Han : 206 a.C.– 220 d.C. : Colección Pedro Lorente*, ed. Isabel Cervera Fernández. 11–37. Valencia: Museu de Prehistòria de València, 2010.

Janousch, Andreas. “La Universidad en la China Imperial.” In *La universidad : una historia ilustrada*, ed. Fernando Tejerina. 16–21. Madrid: Turner Publicaciones, 2010.

- 2 Jarausch, Konrad H., Matthias Middell, and Annette Vogt, eds. *Geschichte der Universität unter den Linden. Vol. 3: Sozialistisches Experiment und Erneuerung in der Demokratie – die Humboldt-Universität zu Berlin 1945–2010*. Berlin: Akademie Verlag, 2012.

Joas, Christian *see also* Hoffmann and Joas

Joas, Christian *see also* Ren, Rinke and Joas

Joas, Christian. “Campos que interage : física quântica e a transferência de conceitos entre física de partículas, nuclear e do estado sólido.” In *Teoria quântica : estudos históricos e implicações culturais*, eds. Olival Freire, Jr., Osvaldo Pessoa, Jr., and Joan Lisa Bromberg. 107–149. Campina Grande: Ed. da Universidade Estadual da Paraíba, 2010.

Joas, Christian and Shaul Katzir. “Analogy, extension, and novelty : young Schrödinger on electric phenomena in solids.” *Studies in History and Philosophy of Modern Physics* 42 (1 2011): 43–53.

Joas, Christian and Georges Waysand. “Von Leitungsketten zur Paarhypothese : die Entdeckung der Supraleitung und die wechselvolle Geschichte ihrer Erklärung.” *Physik-Journal* 10 (6 2011): 23–28.

Jurkowitz, Edward. “Helmholtz’s early empiricism and the ‘Erhaltung der Kraft’” *Annals of Science* 67 (1 2010): 39–78.

Kammer, Stephan. “Das Werk als Entwurf : Textpolitik und Schreibpraxis bei Arthur Schopenhauer.” In *Notieren, Skizzieren : Schreiben und Zeichnen als Verfahren des*

Entwurfs, eds. Karin Krauthausen and Omar W. Nasim. 27–60. Zürich [u. a.]: Diaphanes, 2010.

Kammer, Stephan. “Spinne.” In *Eine Naturgeschichte für das 21. Jahrhundert : hommage à, zu Ehren von, in honor of Hans-Jörg Rheinberger*, 150–152. Berlin: Max-Planck-Institut für Wissenschaftsgeschichte, 2011.

Kant, Horst *see also Renn and Kant*

Kant, Horst. “Berlin – München : das Max-Planck-Institut für Physik.” In *Denkorte : Max-Planck-Gesellschaft und Kaiser-Wilhelm-Gesellschaft ; Brüche und Kontinuitäten 1911–2011*, eds. Peter Gruss and Reinhard Rürup. 316–323. Dresden: Sandstein Verlag, 2010.

Kant, Horst. “[Entries] ‘Hass’, ‘Macke’, ‘Sanke’, ‘Schmellenmeier.’” In *Wer war wer in der DDR? : ein Lexikon ostdeutscher Biographien*, eds. Helmut Müller-Enbergs, Jan Wielgoß, Dieter Hoffmann, Andreas Herbst, and Ingrid Kirschey-Feix. 5., aktual. und erw. Neuausg. Berlin: Links Verlag, 2010.

Kant, Horst. “Hubert Laitko wurde 75 : Bericht vom 80. Dahlemer Archivgespräch am 12. April 2010.” *Leibniz intern : Mitteilungen der Leibniz-Sozietät e. V* (47 2010): 10–11.

Kant, Horst. “[Entry] ‘Schwarzschild, Karl.’” In *Neue Deutsche Biographie. Bd. 24*, Historische Kommission der Bayerischen Akademie der Wissenschaften. 33–34. 4. ed. Berlin: Duncker & Humblot, 2010.

Kant, Horst. “[Entry] ‘Schweigger, Johann Salomo Christoph.’” In *Neue Deutsche Biographie. Bd. 24*, Historische Kommission der Bayerischen Akademie der Wissenschaften. 46–47. 4. ed. Berlin: Duncker & Humblot, 2010.

Kant, Horst. “[Entry] ‘Simon, Franz Eugen.’” In *Neue Deutsche Biographie. Bd. 24*, Historische Kommission der Bayerischen Akademie der Wissenschaften. 431–432. 4. ed. Berlin: Duncker & Humblot, 2010.

Kant, Horst. “Integration und Segregation : das Kaiser-Wilhelm-Institut für Medizinische Forschung in Heidelberg zwischen interdisziplinärem Verbund und Ensemble disziplinärer Institute.” In *Interdisziplinarität und Institutionalisierung der Wissenschaft : Wissenschaftsforschung Jahrbuch 2010*, eds. Klaus Fischer, Hubert Laitko, and Heinrich Parthey. 175–197. Berlin: Wissenschaftlicher Verlag Berlin, 2011.

Kant, Horst. “Peter Debye als Direktor des Kaiser-Wilhelm-Instituts für Physik in Berlin.” In *‘Fremde’ Wissenschaftler im Dritten Reich : die Debye-Affäre im Kontext*, eds. Dieter Hoffmann and Mark Walker. 76–109. Göttingen: Wallstein, 2011.



1

Kant, Horst. "Lise Meitner and the (supposed) transuranic elements." *Annalen der Physik* 524 (6/7 2012): A99–A102.

Kant, Horst. "Die radioaktive Forschung am Kaiser-Wilhelm-Institut für Chemie von den Anfängen bis zum deutschen Uranprojekt." In *100 Jahre Kaiser-Wilhelm-/Max-Planck-Institut für Chemie (Otto-Hahn-Institut) : Facetten seiner Geschichte*, eds. Horst Kant and Carsten Reinhardt. 53–98. Berlin: Archiv der Max-Planck-Gesellschaft, 2012.

- 1 Kant, Horst and Carsten Reinhardt, eds. *100 Jahre Kaiser-Wilhelm-/Max-Planck-Institut für Chemie (Otto-Hahn-Institut) : Facetten seiner Geschichte*. Veröffentlichungen aus dem Archiv der Max-Planck-Gesellschaft ; 22. Berlin: Archiv der Max-Planck-Gesellschaft, 2012.

Kant, Horst and Carsten Reinhardt. "Einführung." In *100 Jahre Kaiser-Wilhelm-/Max-Planck-Institut für Chemie (Otto-Hahn-Institut) : Facetten seiner Geschichte*, eds. Horst Kant and Carsten Reinhardt. 12–20. Berlin: Archiv der Max-Planck-Gesellschaft, 2012.

Kantel, Jörg. "Geld schafft sich ab im Netz! Digitalisiertes Wissen wird zum Gemeingut." *Deutschlandradio Kultur*, 23. 11. 2010: <http://www.dradio.de/dkultur/sendungen/politischesfeuilleton/1325130/>

Kantel, Jörg. "Das iPad ist nur eine Fernbedienung." *Frankfurter Allgemeine Zeitung*, 03. 02. 2010, 31.

Kantel, Jörg. "Lernt programmieren, sonst werdet ihr programmiert! Über die Emanzipation von der Software-Industrie." *Deutschlandradio Kultur*, 27. 10. 2010: <http://www.dradio.de/dkultur/sendungen/politischesfeuilleton/1304444/>

Kantel, Jörg. "Schafft viele Wikileaks!" *Frankfurter Rundschau*, 12. 12. 2010: <http://www.fr-online.de/politik/meinung/schafft-viele-wikileaks/-/1472602/4917202/-/index.html>

Kantel, Jörg. "Der Cyber-War findet nicht statt." *Deutschlandradio Kultur*, 07. 01. 2011: <http://www.dradio.de/dkultur/sendungen/politischesfeuilleton/1358936/>



Kantel, Jörg. “Digitaler Wissensbetrieb : Nomaden des Wissens.” *The European*, 05.06. 2011: <http://www.theeuropean.de/joerg-kantel/6833-web-des-wissens>

Kantel, Jörg. “Open Access : wissenschaftliche Erkenntnisse müssen im Internet frei verfügbar sein!” *Deutschlandradio Kultur*, 05.05. 2011: <http://www.dradio.de/dkultur/sendungen/politischesfeuilleton/1450138/>

Kantel, Jörg. “Publizier Dein Buch selbst : Texte gehören frei verfügbar ins Netz!” *Deutschlandradio Kultur*, 15.02. 2011: <http://www.dradio.de/dkultur/sendungen/politischesfeuilleton/1388242/>

Kantel, Jörg. “Versenkte Notebooks. Der Bundestrojaner : polizeiliche Ermittlungen auf Kosten des Vertrauens der Bürger.” *Deutschlandradio Kultur*, 16.03. 2011 : <http://www.dradio.de/dkultur/sendungen/politischesfeuilleton/1410106/>

Kantel, Jörg. “Wem gehört das Internet?” *Deutschlandradio Kultur – Politisches Feuilleton*, 06.07. 2011: <http://www.dradio.de/dkultur/sendungen/politischesfeuilleton/1497834/>

Kantel, Jörg. “www.maxmuellerluedenschuh Oder: Wem gehört das Internet?” *Lunapark21* 14 (2011): 68–70.

Kantel, Jörg, Peter Damerow, Sarah Köhler, and Christina Tsouparopoulou. “3D-Scans von Keilschrifttafeln – ein Werkstattbericht.” In *26. DV-Treffen der Max-Planck-Institute, 22.–24. September 2009 in Berlin*, eds. Wolfgang Assmann, Christa Hausmann-Jamin, and Frank Malisius. 41–62. Göttingen: Gesellschaft für wissenschaftliche Datenverarbeitung, 2010: <http://www.gwdg.de/fileadmin/inhaltsbilder/Pdf/Publikationen/GWDG-Berichte/gwdg-bericht-76.pdf>

Katzir, Shaul *see also Joas and Katzir*

Katzir, Shaul. “A scientific style in technology : Neumann’s school of physics in technological research.” In *Styles of thinking in science and technology : proceedings of the 3rd International Conference of the European Society for the History of Science ; Vienna, September 10–12, 2008 (CD-ROM)*, eds. Hermann Hunger, Felicitas Seebacher, and Gerhard Holzer. 1086–1089. Wien: Verlag der Österreichischen Akademie der Wissenschaften, 2010.

Katzir, Shaul. "War and peacetime research in the road to crystal frequency control." *Technology and Culture* 51 (1 2010): 99–125.

Katzir, Shaul. "Who knew piezoelectricity? Rutherford and Langevin on submarine detection and the invention of sonar." *Notes and Records of the Royal Society of London* 66 (2 2012): 141–157.

- 1 Kelly, Tatiana and Irina Podgorny. *Los secretos de Barba Azul : fantasías y realidades de los archivos del Museo de La Plata*. Historia de la ciencia. Rosario: Prohistoria Ed., 2012.
- 2 Kindi, Vasso and Theodore Arabatzis, eds. *Kuhn's 'The structure of scientific revolutions' revisited*. Routledge studies in the philosophy of science ; 12. New York [u. a.]: Routledge, 2012.

Klamm, Stefanie. "Neue Originale – Medienpluralität in der Klassischen Archäologie des 19. Jahrhunderts." In *Das Originale der Kopie : Kopien als Produkte und Medien der Transformation von Antike*, eds. Tatjana Bartsch, Marcus Becker, Horst Bredekamp, and Charlotte Schreiter. 47–67. Berlin [u. a.]: de Gruyter, 2010.

Klamm, Stefanie. "Ruinenwahrnehmungen." In *Ein neuer Blick : Architektur-fotografie aus den Staatlichen Museen zu Berlin*, eds. Ludger Derenthal and Christine Kühn. 18–21. Tübingen [u. a.]: Wasmuth, 2010.

Klamm, Stefanie. "Sammeln – Anordnen – Herrichten : vergleichendes Sehen in der Klassischen Archäologie." In *Vergleichendes Sehen*, eds. Lena Bader, Martin Gaier, and Falk Wolf. 383–405. München [u. a.]: Fink, 2010.

Klamm, Stefanie. "Linie – Form – Raum : über wissenschaftliche Bilder antiker Skulpturen." In *Reproduktion : Techniken und Ideen von der Antike bis heute ; eine Einführung*, ed. Jörg Probst. 136–155. Berlin: Reimer, 2011.

Klamm, Stefanie. "Olympia entsteht im Bild – die Klassische Archäologie des 19. Jahrhunderts und ihre Abhängigkeit von medialen Praktiken." In *Wissenskulturen : Bedingungen wissenschaftlicher Innovation*, eds. Harald Müller and Florian Eßer. 87–116. Kassel: Kassel University Press, 2012.

Klein, Ursula. "Ein Bergrat, zwei Minister und sechs Lehrende : Versuche der Gründung einer Bergakademie in Berlin um 1770." *NTM* 18 (4 2010): 437–468.

Klein, Ursula. "Blending technical innovation and learned natural knowledge : the making of ethers." In *Materials and expertise in early modern Europe : between market and laboratory*, eds. Ursula Klein and Emma C. Spary. 125–157. Chicago [u. a.]: The University of Chicago Press, 2010.

Klein, Ursula. "Chemische Wissenschaft und Technologie in der Gründungsphase der Berliner Universität." In *Genese der Disziplinen : die Konstitution der Universität*, ed. Heinz-Elmar Tenorth. 447–464. Berlin: Akademie Verlag, 2010.

Klein, Ursula. "Introduction: Why materials?" In *Materials and expertise in early modern Europe : between market and laboratory*, eds. Ursula Klein and Emma C. Spary. 1–23. Chicago [u. a.]: The University of Chicago Press, 2010.

Klein, Ursula. "Amb qué experimentaven els químics? El món de les substàncies en la química del segle XVIII." *Mètode* 69 (2011): 64–71.

Klein, Ursula. "Ether." In *Eine Naturgeschichte für das 21. Jahrhundert : hommage à, zu Ehren von, in honor of Hans-Jörg Rheinberger*, 171–173. Berlin: Max-Planck-Institut für Wissenschaftsgeschichte, 2011.

- 1 Klein, Ursula, ed. *Artisanal-scientific experts in eighteenth-century France and Germany*. *Annals of Science* ; 69/3. Special journal issue. London: Taylor & Francis, 2012.

Klein, Ursula. "Introduction: Artisanal-scientific experts in eighteenth-century France and Germany." *Annals of Science* 69 (3 2012): 303–306.

Klein, Ursula. "Objects of inquiry in classical chemistry : material substances." *Foundations of Chemistry* 14 (1 2012): 7–23.

Klein, Ursula. "The Prussian mining official Alexander von Humboldt." *Annals of Science* 69 (1 2012): 27–68.

Klein, Ursula. "Savant officials in the Prussian mining administration." *Annals of Science* 69 (3 2012): 349–374.

Klein, Ursula. "La tabla de 'Rapports' de E. F. Geoffroy : estructura y contexto social." In *La representación de lo invisible : tabla de los diferentes 'Rapports' observados en la química entre diferentes sustancias de Etienne-François Geoffroy*, ed. Pere Grapi Vilumara. 89–122. Alicante: Universidad de Alicante, 2012.

Klein, Ursula. "What did chemists experiment with? : material substances in eighteenth-century chemistry." *Mètode : annual review* 2 (2012): 39–45.

- 2 Klein, Ursula and Emma C. Spary, eds. *Materials and expertise in early modern Europe : between market and laboratory*. Chicago [u. a.]: The University of Chicago Press, 2010.

Kojevnikov, Alexei B. "A grande ciência de Stalin: tempos e aventuras de físicos soviéticos no exemplo da biografia política de Lev Landau." *Revista da Sociedade Brasileira de História da Ciência* 4 (1 2011): 6–15.

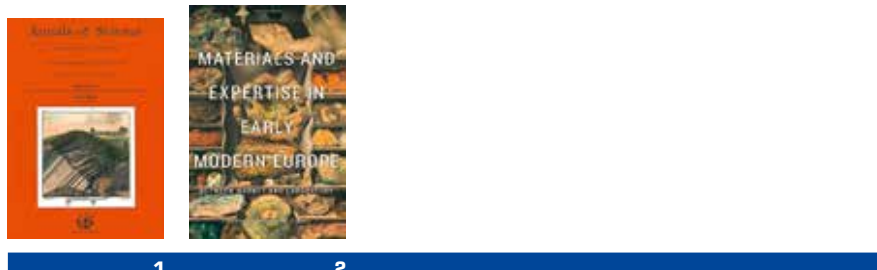

Kojevnikov, Alexei B. “Die Mobilmachung der sowjetischen Wissenschaft.” In *Macht und Geist im Kalten Krieg*, eds. Bernd Greiner, Tim B. Müller, and Claudia Weber. 87–107. Hamburg: Hamburger Edition, 2011.

Kojevnikov, Alexei B. “Philosophical rhetoric in early quantum mechanics 1925–27 : high principles, cultural values and professional anxieties.” In *Weimar culture and quantum mechanics : selected papers by Paul Forman and contemporary perspectives on the Forman thesis*, eds. Cathryn Carson, Alexei B. Kojevnikov, and Helmuth Trischler. 319–348. London [u. a.]: Imperial College Press [u. a.], 2011.

Krämer, Fabian. “Faktoid und Fallgeschichte : medizinische Fallgeschichten im Lichte frühneuzeitlicher Lese- und Aufzeichnungstechniken.” In *Die Sachen der Aufklärung : Beiträge zur DGEJ-Jahrestagung 2010 in Halle a. d. Saale*, eds. Frauke Bernd and Daniel Fulda. 525–536. Hamburg: Meiner, 2012.

Krakauer, David C., James P. Collins, Douglas Erwin, Jessica C. Flack, Walter Fontana, Manfred Dietrich Laubichler, Sonja J. Prohaska, Geoffrey B. West, and Peter F. Stadler. “The challenges and scope of theoretical biology.” *Journal of Theoretical Biology* 276 (1 2011): 269–276.

Krampf, Arie. “Economic planning of the free market in Israel during the first decade : the influence of Don Patinkin on Israeli policy discourse.” *Science in Context* 23 (4 2010): 507–534.

Krampf, Arie. “(in Hebrew) Metaphysics of factuality : social measurement in Israel in historical and comparative perspectives.” In *Everything is measurable?! Critical aspects of quantification and rating*, eds. Yohay Hakak, Lea Kesen, and Michal Kromer-Nevo. 105–130. Be’er Sheva: Ben-Gurion University Press, 2010.

Krampf, Arie. “The reception of the developmental approach in the Jewish economic discourse in Mandatory Palestine, 1934–1938.” *Israel Studies* 15 (2 2010): 80–103.

Krampf, Arie. “Translation of central banking to developing countries in the post-world war II period : the case of the Bank of Israel.” In *The globalization of knowledge in history*, ed. Jürgen Renn. 459–481. Berlin: epubli GmbH, 2012: http://www.edition-open-access.de/studies/1/chapter_23.html



- 1 Kranz, Claudine, Hansjörg Quaderer, and Hans-Jörg Rheinberger, eds. *Album für Robert Allgauer 75*. Frankfurt am Main [u. a.]: Stroemfeld, 2012.

Krauthausen, Karin *see also Epple and Krauthausen*

Krauthausen, Karin *see also Rheinberger and Krauthausen*

Krauthausen, Karin. "Geometrie als Schreibmedium bei Paul Valéry." *Zeitschrift für Medienwissenschaft* 2 (1 2010): 15–23.

Krauthausen, Karin. "Gespräche mit Untoten : das konjunktivische Interview in Kathrin Rögglas Roman 'wir schlafen nicht.'" In *Schreibweisen, Poetologien. Vol. 2: Zeitgenössische österreichische Literatur von Frauen*, ed. Hildegard Kernmayer. 191–215. Wien: Milena-Verlag, 2010.

Krauthausen, Karin. "Paul Valéry and geometry : instrument, writing model, practice." *Configurations* 18 (3 2010): 231–249.

Krauthausen, Karin. "Vom Nutzen des Notierens : Verfahren des Entwurfs." In *Notieren, Skizzieren : Schreiben und Zeichnen als Verfahren des Entwurfs*, eds. Karin Krauthausen and Omar W. Nasim. 7–26. Zürich [u. a.]: Diaphanes, 2010.

Krauthausen, Karin. "Wirkliche Fiktionen : Gedankenexperimente in Wissenschaft und Literatur." In *Experiment und Literatur : Themen, Methoden, Theorien*, ed. Michael Gamper. 278–320. Göttingen: Wallstein, 2010.

Krauthausen, Karin. "Zwischen Aufzeichnung und Konfiguration : der Beginn von Paul Valérys 'Cahiers'" In *Notieren, Skizzieren : Schreiben und Zeichnen als Verfahren des Entwurfs*, eds. Karin Krauthausen and Omar W. Nasim. 89–118. Zürich [u. a.]: Diaphanes, 2010.

Krauthausen, Karin. "Strandgut." In *Eine Naturgeschichte für das 21. Jahrhundert : hommage à, zu Ehren von, in honor of Hans-Jörg Rheinberger*, 154–156. Berlin: Max-Planck-Institut für Wissenschaftsgeschichte, 2011.

Krauthausen, Karin. "Hans Blumenbergs möglicher Valéry." *Zeitschrift für Kulturphilosophie* (1 2012): 39–64.

Krauthausen, Karin. "Hans Blumenbergs präparierter Valéry." *Zeitschrift für Kulturphilosophie* (1 2012): 211–224.

Krauthausen, Karin. "'My psychology': Überlegungen zu Paul Valérys Exploration der Imagination." In *Autorität des Wissens : Kunst- und Wissenschaftsgeschichte im Dialog*, 83–101. Zürich: Diaphanes, 2012.

Krauthausen, Karin. "Von Dingen, Resten und Findekünsten bei Paul Valéry." In *Die Wiederkehr der Dinge*, eds. Friedrich Balke, Maria Muhle, and Antonia von Schönning. 151–173. Berlin: Kulturverlag Kadmos, 2012.

- 2 Krauthausen, Karin and Omar W. Nasim, eds. *Notieren, Skizzieren : Schreiben und Zeichnen als Verfahren des Entwurfs*. Wissen im Entwurf ; 3. Zürich [u. a.]: Diaphanes, 2010.

Kremer, Richard L. "Experimenting with paper instruments in fifteenth- and sixteenth-century astronomy : computing syzygies with isothermal lines and salt dishes." *Journal for the History of Astronomy* 42 (2 2011): 223–258.

Kremer, Richard L. "Reforming American physics pedagogy in the 1880s : introducing 'learning by doing' via student laboratory exercises." In *Learning by doing : experiments and instruments in the history of science teaching*, eds. Peter Heering and Roland Wittje. 243–280. Stuttgart: Steiner, 2011.

Kremer, Richard L. "Educating the high-speed eye : Harold E. Edgerton's early visual conventions." In *The educated eye : visual culture and pedagogy in the life sciences*, eds. Nancy Anderson and Michael R. Dietrich. 186–212. Hanover, N.H.: Dartmouth College Press, 2012.

Kundert Ursula *see Gindhart and Kundert*

Kursell, Julia *see also Azzouni, Brandt, Gausemeier and Kursell*

Kursell, Julia. "First person plural : Roman Jakobson's grammatical fictions." *Studies in East European Thought* 62 (2 2010): 217–236.

Kursell, Julia. "Helmholtzquinten." In *Dilettantismus als Beruf*, eds. Safia Azzouni and Uwe Wirth. 131–142. Berlin: Kulturverlag Kadmos, 2010.

Kursell, Julia. "Immanenzebene : zur elektronischen Musik von David Tudor." In *Klangmaschinen zwischen Experiment und Medientechnik*, ed. Daniel Gethmann. 231–247. Bielefeld: Transcript, 2010.

Kursell, Julia. "Moscow eye and ear control : über die neurophysiologischen Arbeiten von Nikolaj Bernstein zum Klavierspiel." In *Ultravision : zum Wissenschaftsverständnis der Avantgarde*, eds. Sabine Flach and Margarete Vöhringer. 83–105. München: Fink, 2010.

Kursell, Julia. "Elefant." In *Eine Naturgeschichte für das 21. Jahrhundert : hommage à, zu Ehren von, in honor of Hans-Jörg Rheinberger*, 109–110. Berlin: Max-Planck-Institut für Wissenschaftsgeschichte, 2011.

Kursell, Julia. "A grey box : the phonograph in laboratory experiments and field-work, 1900–1920." In *The Oxford handbook of sound studies*, eds. Trevor Pinch and Karin Bijsterveld. 176–197. New York: Oxford University Press, 2011.

Kursell, Julia. "Visualizing Piano Playing, 1890–1930." *Grey Room* 43 (Spring 2011): 66–87.

Kursell, Julia. "'Presque une image matérielle' : die serielle Musik von Jean Barraqué." *Zeitschrift für Medienwissenschaft* 7 (2 2012): 57–69.

Kursell, Julia and Armin Schäfer. "Fliehend wie der Schall : Olivier Messiaen." *Archiv für Mediengeschichte* 11 (2011): 99–113.

Kursell, Julia and Armin Schäfer. "Kräftespiel : zur Dissymmetrie von Schall und Wahrnehmung." *Zeitschrift für Medienwissenschaft* 2 (1 2010): 189–218.

- 1 Kutrovátz, Gábor, Benedek Láng, and Gábor Á. Zemplén, eds. *Határmunkálatok a tudományban. Tudománytörténet és tudományfilozófia* ; 2010, 7/2. Budapest: L'Harmattan, 2010.

Langlitz, Nicolas. "'Better Living Through Chemistry' : Entstehung, Scheitern und Renaissance einer psychedelischen Alternative zur kosmetischen Psychopharmakologie." In *Die Debatte über 'Human Enhancement' : historische, philosophische und ethische Aspekte der technologischen Verbesserung des Menschen*, eds. Christopher Coenen, Stefan Gammel, Reinhard Heil, and Andreas Woyke. 263–286. Bielefeld: Transcript, 2010.

Langlitz, Nicolas. "Kultivierte Neurochemie und unkontrollierte Kultur : über den Umgang mit Gefühlen in der psychopharmakologischen Halluzinogenforschung ; Debatte mit Malek Bajbouj, Ludwig Jäger und Boris Quednow." *Zeitschrift für Kulturwissenschaften* (2 2010): 61–88.

Langlitz, Nicolas. "The persistence of the subjective in neuropsychopharmacology : observations of contemporary hallucinogen research." *History of the Human Sciences* 23 (1 2010): 37–57.

Langlitz, Nicolas. "Political neurotheology : emergence and revival of a psychedelic alternative to cosmetic psychopharmacology." In *Neurocultures : glimpses into an expanding universe*, eds. Francisco Ortega and Fernando Vidal. 141–165. Frankfurt/M. [u. a.]: Lang, 2011.

Langlitz, Nicolas. "Delirious brain chemistry and controlled culture : exploring the contextual mediation of drug effects." In *Critical neuroscience : a handbook of the*



1

2

social and cultural contexts of neuroscience, eds. Suparna Choudhury and Jan Slaby. 253–262. Chichester: Wiley-Blackwell, 2012.

Laubichler, Manfred Dietrich *see also Elkana and Laubichler*

Laubichler, Manfred Dietrich *see also Gorelick and Laubichler*

Laubichler, Manfred Dietrich *see also Krakauer, Collins, Erwin, Flack, Fontana and Laubichler*

Laubichler, Manfred Dietrich *see also Leimar, Hartfelder and Laubichler*

Laubichler, Manfred Dietrich *see also Linksvayer, Fewell, Gadau and Laubichler*

Laubichler, Manfred Dietrich *see also Maienschein and Laubichler*

Laubichler, Manfred Dietrich. “Robert Lepage’s vision.” *Jahrbuch / Wissenschaftskolleg zu Berlin – Institute for Advanced Study 2009/2010* (2010): 120–122.

Laubichler, Manfred Dietrich. “Urknall? Darwin?” *Frankfurter Allgemeine Zeitung*, 14.04.2010.

Laubichler, Manfred Dietrich. “Embryonalentwicklung.” In *Eine Naturgeschichte für das 21. Jahrhundert : hommage à, zu Ehren von, in honor of Hans-Jörg Rheinberger*, 80–82. Berlin: Max-Planck-Institut für Wissenschaftsgeschichte, 2011.

Laubichler, Manfred Dietrich and W. Callebaut. “The Moody’s virus attacks the U. S. national science board.” *Biological Theory* 5 (1 2010): 1–2.

Laubichler, Manfred Dietrich and Gitta Honegger. “Of locusts and scientists : Heuschrecken [locusts] by Stefan Kaegi; scenography by Dominic Huber; music by Bo Wiget. Rimini Protokoll. Schauspielhaus Zürich 2009. HAU Berlin 2010.” *Science* 327 (2010): 525–526.

- 2 Lazardzig, Jan, Viktoria Tkaczyk, and Matthias Warstat. *Theaterhistoriografie : eine Einführung*. UTB ; 3362. Tübingen [u. a.]: Francke, 2012.



Ledebur, Sophie. “Schreiben und Beschreiben : zur epistemischen Funktion von psychiatrischen Krankenakten, ihrer Archivierung und deren Übersetzung in Fallgeschichten.” *Berichte zur Wissenschaftsgeschichte* 34 (2 2011): 102–124.

Ledebur, Sophie. “Zur Epistemologie einer Ausschlußdiagnose : Unwissen, Diskurs und Untersuchungstechniken bei Simulation psychischer Erkrankungen.” In *Wissen und Nicht-Wissen in der Klinik : Dynamiken der Psychiatrie um 1900*, ed. Martina Wernli. 17–50. Bielefeld: Transcript, 2012.

Lefèvre, Wolfgang. “Natürliches Bild und Naturabguss : zur Bildnatur gewisser Fossilien.” *Bildwelten des Wissens* 8 (1 2010): 95–102.

Lefèvre, Wolfgang. “Der verkannte Lamarck.” In *Das Werden des Lebendigen : Beiträge zur 18. Jahrestagung der DGGB in Halle (Saale) 2009*, eds. Michael Kaasch and Joachim Kaasch. 71–83. Berlin: VWB-Verlag, 2010.

Lefèvre, Wolfgang. “Symbolic technology politics.” In *Cultures of knowledge : technology in Chinese history*, ed. Dagmar Schäfer. 147–154. Leiden [u. a.]: Brill, 2012.

Lefèvre, Wolfgang. “Viewing chemistry through its ways of classifying.” *Foundations of Chemistry* 14 (1 2012): 25–36.

- 1 Lehmann-Brauns, Susanne. *Jerusalem sehen : Reiseberichte des 12. bis 15. Jahrhunderts als empirische Anleitung zur geistigen Pilgerfahrt*. Berliner Kulturwissenschaft ; 9. Freiburg, Br. [u. a.]: Rombach, 2010.

Lehner, Christoph *see also Freire and Lehner*

Lehner, Christoph *see also Renn and Lehner*

Lehner, Christoph. “O realismo de Einstein e sua crítica da mecânica quântica.” In *Teoria quântica : estudos históricos e implicações culturais*, eds. Olival Freire, Jr., Osvaldo Pessoa, Jr., and Joan Lisa Bromberg. 181–228. Campina Grande: Ed. da Universidade Estadual da Paraíba, 2010.

Lehner, Christoph. “Mathematical foundations and physical visions : Pascual Jordan and the field theory program.” In *Mathematics meets physics : a contribution to their*

interaction in the 19th and the first half of the 20th century, eds. Karl-Heinz Schlote and Martina Schneider. 271–293. Frankfurt am Main: Deutsch, 2011.

- 2 Lehner, Christoph, Jürgen Renn, and Matthias Schemmel, eds. *Einstein and the changing worldviews of physics*. Einstein Studies ; 12. Boston [u. a.]: Birkhäuser, 2012.
- 3 Lehoux, Daryn. *What did the Romans know? An inquiry into science and worldmaking*. Chicago [u. a.]: The University of Chicago Press, 2012.

Leimar, Olof, Klaus Hartfelder, Manfred Dietrich Laubichler, and Robert E. Page. “Development and evolution of caste dimorphism in honeybees – a modeling approach.” *Ecology and Evolution* 2 (12 2012): 3098–3109.

Lemke, Martin, Tobias Breidenmoser, Manfred Drack, and Fynn Ole Engler. “Klassifikation von wissenschaftlichen Darstellungen.” In *Visualisierung und Erkenntnis : Bildverstehen und Bildverwenden in Natur- und Geisteswissenschaften*, eds. Dimitri Liebsch and Nicola Mößner. 178–206. Köln: von Halem, 2012.

Lemov, Rebecca. “‘Hypothetical machines’ : the science fiction dreams of cold war social science.” *Isis* 101 (2 2010): 401–411.

Lemov, Rebecca. “Filing the total human : anthropological archives from 1928 to 1963.” In *Social knowledge in the making*, eds. Charles Camic, Neil Gross, and Michèle Lamont. 119–150. Chicago: University of Chicago Press, 2011.

Leonhard, Karin. “Die Muschel als symbolische Form, oder: Wie Rembrandts Conus marmoreus nach Oxford kam.” In *Vom Objekt zum Bild : piktorale Prozesse in Kunst und Wissenschaft, 1600–2000*, ed. Bettina Gockel. 123–155. Berlin: Akademie Verlag, 2011.

- 4 Lewis, Rhodri. *William Petty on the order of nature : an unpublished manuscript treatise*. Medieval and Renaissance texts and studies ; 399. Tempe, AZ: ACMRS, 2012.

Linksvayer, Timothy A., Jennifer H. Fewell, Jürgen Gadau, and Manfred Dietrich Laubichler. “Developmental evolution in social insects : regulatory networks from genes to societies.” *Journal of Experimental Zoology : B* 318 (3 2012): 159–169.

Lipphardt, Veronika. “Die Bequemlichkeit des Erbes : Ist Thilo Sarrazin ein Rassist? Eine Betrachtung über Wesen und Verwendung des biologischen Determinismus in unserer Zeit.” *Freitag*, 15. 09. 2010, 18: <http://www.freitag.de/wissen/1037-die-bequemlichkeit-des-erbes>

Lipphardt, Veronika. “The Jewish community in Rome : an isolated population? Sampling procedures and bio-historical narratives in genetic analysis in the 1950s.” *BioSocieties* 5 (3 2010): 306–329.

Lipphardt, Veronika. "Knowing Europe, Europeanizing knowledge : the making of „Homo Europaeus“ in the life sciences." In *Europeanization in the twentieth century : historical approaches*, eds. Martin Conway and Kiran Klaus Patel. 64–83. Basingstoke, Hampshire [u.a.]: Palgrave Macmillan, 2010.

Lipphardt, Veronika. "Isolates and crosses in human population genetics, or : a contextualization of German race science." *Current Anthropology* 53 (S5 2012): S69–S82.

Lipphardt, Veronika and David Ludwig. "Knowledge transfer and science transfer." *EGO European History Online* (2011):
<http://www.ieg-ego.eu/lipphardtv-ludwigd-2011-en>

Lipphardt, Veronika and David Ludwig. "Wissens- und Wissenschaftstransfer." *EGO Europäische Geschichte Online* (2011): 1–40:
<http://www.ieg-ego.eu/lipphardtv-ludwigd-2011-de>

Lockhart, William. "Towards the third way : interdisciplinary attitudes to the history and practice of listening ; report of discussions." *Journal of the Royal Musical Association* 135 (Supp. 1 2010): 109–118.

Lockhart, William. "Trial by ear : legal attitudes to the keyboard arrangement in nineteenth-century Britain." *Music and Letters* 93 (2 2012): 191–221.

Ludwig, David *see Lipphardt and Ludwig*

Lund, Hannah Lotte. "Eine Menge umgänglicher Bekannte von meinem Gehege' : Salongeselligkeit zwischen Berlin und Brandenburg um 1800 – Knotenpunkte im kommunikativen Netz." In *Salons und Musenhöfe : neuständische Geselligkeit in Berlin und in der Mark Brandenburg um 1800*, eds. Reinhard Blänkner and Wolfgang de Bruyn. 49–74. Hannover: Wehrhahn, 2010.

Lund, Hannah Lotte. "On the diversity of human languages constructions ... : Spain and the Spaniards in the travel writings of Alexander, Wilhelm and Caroline von Humboldt and their reflections in the Berlin Republic of Letters around 1800." In *El viaje y la percepción del otro : viajeros por la Península Ibérica y sus descripciones (siglos XVIII y XIX) = Travelling and the perception of the Other: travellers on the Iberian Peninsula and their travel descriptions in the 18th and 19th centuries*, ed. Ricarda Musser. 25–49. Madrid: Iberoamericana [u. a.], 2011.

Maas, Ad. "Civil scientists : Dutch scientist between 1750 and 1875." *History of Science* 48 (1 2010): 75–103.

Maas, Harro. "Sorting things out : the economist as an armchair observer." In *Histories of scientific observation*, eds. Lorraine Daston and Elizabeth Lunbeck. 206–229. Chicago: University of Chicago Press, 2011.



Maienschein, Jane and Manfred Dietrich Laubichler. “The embryo project : an integrated approach to history, practices and social contexts of embryo research.” *Journal of the History of Biology* 43 (1 2010): 1–16.

Maienschein, Jane and Manfred Dietrich Laubichler. “Charles Gillispie in the digital age.” In *A master of science history : essays in honor of Charles Coulston Gillispie*, ed. Jed Z. Buchwald. 37–45. Dordrecht [u. a.]: Springer, 2012.

Manjapra, Kris K. *see also Bose and Manjapra*

Manjapra, Kris K. “Communist internationalism and transcolonial recognition.” In *Cosmopolitan thought zones : South Asia and the global circulation of ideas*, eds. Sugata Bose and Kris K. Manjapra. 159–177. Houndmills [u. a.]: Palgrave Macmillan, 2010.

Manzo, Silvia. “Introduzione generale.” In Francesco Bacone: Opere. Vol. 15/2: *Scritti scientifici*, ed. Benedino Gemelli. 9–44. Torino: UTET, 2010.

- 1 Marinelli, Lydia and Andreas Mayer. *Sognare a libro aperto : „L'interpretazione dei sogni“ di Freud e la storia del movimento psicoanalitico*. Translated by Bertani Corrado. Nuova cultura ; 235. Torino: Bollati Boringhieri, 2010.
- 2 Marinelli, Lydia and Andreas Mayer. *Soñar con Freud : la interpretación de los sueños y la historia del movimiento psicoanalítico*. Translated by José Amícola. Teoría y ensayo. Buenos Aires: El cuenco de plata, 2011.
- 3 Marr, Alexander. *Between Raphael and Galileo : Mutio Oddi and the mathematical culture of late Renaissance Italy*. Chicago [u. a.]: University of Chicago Press, 2011.

Marx, Werner and Dieter Hoffmann. “Bibliometric analysis of fifty years of physica status solidi.” *Physica status solidi : B* 248 (12 2011): 2762–2771.

Mayer, Andreas *see also Marinelli and Mayer*

Mayer, Andreas. “The physiological circus : knowing, representing, and training horses in motion in nineteenth-century France.” *Representations* 111 (2010): 88–120.



Mayer, Andreas. “Un livre à plusieurs voix – L’interprétation du rêve.” *Sciences humaines. Les grands dossiers* (No. 21 2010): 20–21.

Mayer, Andreas. “Pferd.” In *Eine Naturgeschichte für das 21. Jahrhundert : hommage à, zu Ehren von, in honor of Hans-Jörg Rheinberger*, 105–107. Berlin: Max-Planck-Institut für Wissenschaftsgeschichte, 2011.

Mayer, Andreas. “Gradiva rediviva : ein Bewegungsbild zwischen Wissenschaft und Phantasie.” In *Freud und die Antike*, eds. Claudia Benthien, Hartmut Böhme, and Inge Stephan. 117–142. Göttingen: Wallstein, 2011.

Mayer, Andreas. “Gradiva’s gait : tracing the figure of a walking woman.” *Critical Inquiry* 38 (3 2012): 554–578.

1 Mazzolini, Renato G. and Hans-Jörg Rheinberger, eds. *Differing routes to stem cell research : Germany and Italy*. Annali dell’ Istituto Storico Italo-Germanico in Trento : contributi ; 26. Bologna: Società editrice il Mulino [u. a.], 2012.

2 McLaughlin, Peter, ed. *Brentano, Margherita von: Akademische Schriften*. Göttingen: Wallstein, 2010.

McLaughlin, Peter. “The arrival of the fittest.” In *Explanation, prediction, and confirmation*, eds. Dennis Dieks, J. Gonzales Wenceslao, Stephan Hartmann, Thomas Uebel, and Marcel Weber. 203–222. Dordrecht [u. a.]: Springer, 2011.

McLaughlin, Peter. “Sloth.” In *Eine Naturgeschichte für das 21. Jahrhundert : hommage à, zu Ehren von, in honor of Hans-Jörg Rheinberger*, 104–105. Berlin: Max-Planck-Institut für Wissenschaftsgeschichte, 2011.

Meloni, Maurizio. “The cerebral subject at the junction of naturalism and anti-naturalism.” In *Neurocultures : glimpses into an expanding universe*, eds. Francisco Ortega and Fernando Vidal. 101–115. Frankfurt/M. [u. a.]: Lang, 2011.

Messner, Angelika C. “Negotiations of humanness and body politics in historical contexts.” In *Traces of humanism in China : tradition and modernity*, ed. Carmen Meinert. 83–102. Bielefeld: Transcript, 2010.

- Messner, Angelika C. “Reinheit als Ermöglichungs- und Einübungsdiskurs von Neuordnung und Transgression im chinesischen historischen Kontext.” In *Reinheit*, eds. Peter Burschel and Christoph Marx. 97–118. Wien [u. a.]: Böhlau, 2011.
- Messner, Angelika C. and Martina Siebert. “Scienza e tecnologia.” In *La Cina. Vol. 2: Letà imperiale dai Tre regni ai Qing*, eds. Mauro Scarpari and Mario Sabattini. 867–943. Torino: Einaudi, 2010.
- Métraux, Alexandre. “Phänomenologie.” In *Wissenschaftstheorie*, eds. Detlef Horster and Wolfgang Jantzen. 229–234. Stuttgart: Kohlhammer, 2010.
- Meunier, Robert. “Essay review of: Falk, Raphael: Genetic analysis : a history of genetic thinking. Cambridge: Cambridge Univ. Press 2010.” *Prolegomena* 11 (1 2012): 109–114:
http://hrcak.srce.hr/index.php?show=clanak&id_clanak_jezik=123802
- Meunier, Robert. “Stages in the development of a model organism as a platform for mechanistic models in developmental biology: Zebrafish, 1970–2000.” *Studies in History and Philosophy of Biological and Biomedical Sciences* 43 (2 2012): 522–531.
- Milam, Erika L. “Beauty and the beast? : conceptualizing sex in evolutionary narratives.” In *Biology and ideology from Descartes to Dawkins*, eds. Denis R. Alexander and Ronald L. Numbers. 277–301. Chicago [u. a.]: The University of Chicago Press, 2010.
- 3** Milam, Erika L. *Looking for a few good males : female choice in evolutionary biology*. Animals, history, culture. Baltimore: John Hopkins University Press, 2010.
- Mingarelli, Angelo, José M. Pacheco, and Samuel Melkonian. “A complete asymptotic analysis of an oscillation-free nonlinear equation of Bessel type with a pole in the dependent variable.” *Nonlinear oscillations* 13 (2 2010): 206–239.
- Mitman, Gregg and Paul Erickson. “Latex and blood : science, markets, and American Empire.” *Radical History Review* 107 (2010): 45–73.
- 4** Morrison-Low, Alison D., Sven Dupré, Stephen Johnston, and Giorgio Strano, eds. *From earth-bound to satellite : telescopes, skills and networks*. History of Science and Medicine Library ; 23. Leiden [u. a.]: Brill, 2012.
- Mota, Bernardo Machado. “The astronomical interpretation of ‘Catoptrica.’” *Science in Context* 25 (4 2012): 469–502.
- 5** Müller-Enbergs, Helmut, Jan Wielgohs, Dieter Hoffmann, Andreas Herbst, and Ingrid Kirschey-Feix, eds. *Wer war wer in der DDR? : ein Lexikon ostdeutscher Biographien*. 5., aktual. und erw. Neuausg. Berlin: Links Verlag, 2010.

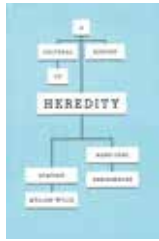

1

Müller-Wille, Staffan *see O'Malley and Müller-Wille*

Müller-Wille, Staffan. "Cell theory, specificity, and reproduction, 1837–1870." *Studies in History and Philosophy of Biological and Biomedical Sciences* 41 (3 2010): 225–231.

Müller-Wille, Staffan. "Claude Lévi-Strauss on race, history and genetics." *BioSocieties* 5 (3 2010): 330–347.

Müller-Wille, Staffan. "[Entries] 'Evolutionstheorien vor Darwin', 'Gene', 'Variation', 'Vererbung.'" In *Evolution : ein interdisziplinäres Handbuch*, eds. Philipp Sarasin and Marianne Sommer. 52–57, 65–78. Stuttgart: Metzler, 2010.

Müller-Wille, Staffan. "History of science and medicine." In *The Oxford handbook of the history of medicine*, ed. Mark Jackson. 469–483. Oxford: Oxford University Press, 2011.

Müller-Wille, Staffan. "Making sense of essentialism." *Critical Quarterly* 53 (4 2011): 61–77.

Müller-Wille, Staffan. "Vom Sexualsystem zur Karteikarte : Carl von Linnés Papiertechnologien." In *Nicht Fisch – nicht Fleisch : Ordnungssysteme und ihre Störfälle*, eds. Thomas Bäumler, Benjamin Bühler, and Stefan Rieger. 33–50. Zürich: Diaphanes, 2011.

Müller-Wille, Staffan. "Yucca." In *Eine Naturgeschichte für das 21. Jahrhundert : hommage à, zu Ehren von, in honor of Hans-Jörg Rheinberger*, 53–54. Berlin: Max-Planck-Institut für Wissenschaftsgeschichte, 2011.

Müller-Wille, Staffan. "The economy of nature in classical natural history." *Историко-биологические исследования / Istoriko-biologicheskie issledovaniia* 4 (4 2012): 38–49.

Müller-Wille, Staffan. "'Thinking plants'. Essay review of Ayres, Peter: *The aliveness of plants : the Darwins at the dawn of plant science*. London: Pickering & Chatto 2008." *Notes and Records of the Royal Society of London* 66 (1 2012): 101–103.

Müller-Wille, Staffan and Katrin Böhme. "Biologie : Wissenschaft vom Werden, Wissenschaft im Werden." In *Genese der Disziplinen : die Konstitution der Universität*, ed. Heinz-Elmar Tenorth. 425–446. Berlin: Akademie Verlag, 2010.

Müller-Wille, Staffan and Isabelle Charmantier. "Natural history and information overload : the case of Linnaeus." *Studies in History and Philosophy of Biological and Biomedical Sciences* 43 (1 2012): 4–15.

Müller-Wille, Staffan and Maria Kronfeldner. "How to see the trees for the forest : introduction to a special issue on 'Causation and disease'." *History and Philosophy of the Life Sciences* 33 (4 2011): 445–452.

- 1 Müller-Wille, Staffan and Hans-Jörg Rheinberger. *A cultural history of heredity*. Chicago [u. a.]: University of Chicago Press, 2012.

Müller-Wille, Staffan and Sara Scharf. "Indexing nature : Carl Linnaeus and his fact gathering strategies." *Svenska Linné-Sällskapets årsskrift 2011 (2012)*: 31–60.

Nasim, Omar W. *see also Krauthausen and Nasim*

Nasim, Omar W. *see also Rheinberger, Krauthausen and Nasim*

Nasim, Omar W. "Observation, working images and procedure : the 'Great Spiral' in Lord Rosse's astronomical record books and beyond." *The British Journal for the History of Science* 44 (3 2010): 353–389.

Nasim, Omar W. "Zeichnen als Mittel der 'Familiarization' : zur Erkundung der Nebel im Lord Rosse-Projekt." In *Notieren, Skizzieren : Schreiben und Zeichnen als Verfahren des Entwurfs*, eds. Karin Krauthausen and Omar W. Nasim. 159–188. Zürich [u. a.]: Diaphanes, 2010.

Nasim, Omar W. "The 'Landmark' and 'Groundwork' of stars : John Herschel, photography and the drawing of nebulae." *Studies in History and Philosophy of Science* 42 (2011): 67–84.

Nasim, Omar W. "Nebulae." In *Eine Naturgeschichte für das 21. Jahrhundert : hommage à, zu Ehren von, in honor of Hans-Jörg Rheinberger*, 165–166. Berlin: Max-Planck-Institut für Wissenschaftsgeschichte, 2011.

Navarro, Jaume. "Electron diffraction *chez* Thomson : early responses to quantum physics in Britain." *The British Journal for the History of Science* 43 (2 2010): 245–275.

Navarro, Jaume. "Religious truth and scientific relativism." In *How do we know? : understanding in science and theology / Studies in Science and Theology* ; 12, eds. Dirk Evers, Antje Jackelén, and Taede A. Smedes. 169–178. Tübingen: Forum Scientiarum, 2010.



Navarro, Jaime. “Introduction: ‘Science, faith and reason’ versus ‘science and religion’ : the question of boundaries.” In *Science and faith within reason : reality, creation, life and design*, ed. Jaime Navarro. 1–8. Farnham, Surrey [u. a.]: Ashgate, 2011.

Navarro, Jaime. “Joseph John Thomson : una vida entre electrones, átomos y espíritus.” In *De las ciencias a la teología : ensayos interdisciplinarios en homenaje a Manuel García Doncel*, ed. Jesús Romero Moñivas. 83–93. Pamplona: Editorial Verbo Divino, 2011.

- 1 Navarro, Jaime, ed. *Science and faith within reason : reality, creation, life and design*. Ashgate Science and Religion Series. Farnham, Surrey [u. a.]: Ashgate, 2011.

Navarro, Jaime. “A Victorian theory of the multiverse : ‘The unseen universe’ and the notion of creation.” In *Science and faith within reason : reality, creation, life and design*, ed. Jaime Navarro. 83–102. Farnham, Surrey [u. a.]: Ashgate, 2011.

- 2 Navarro, Jaime. *A history of the electron : J. J. and G. P. Thomson*. Cambridge [u. a.]: Cambridge University Press, 2012.

Nelson, Alondra *see Wailoo and Nelson*

Németh, András *see also Boreczky and Németh*

Németh, András. “Egy újabb nemzetközi jelentőségű kódextörredék az Országos Széchényi Könyvtárban.” In *Szöveg – emlék – kép*, eds. László Boka and Judit Vásárhelyi. 25–46. Budapest: Gondolat, 2011.

Németh, András. “The Mynas codex and the Bibliotheca Corviniana.” In *Matthias Corvinus und seine Zeit : Europa am Übergang vom Mittelalter zur Neuzeit zwischen Wien und Konstantinopel*, eds. Christian Gastgeber, Ekaterini Mitsiou, Ioan-Aurel Pop, Mihailo Popovic, Johannes Preiser-Kapeller, and Alexandru Simon. 155–178. Wien: Verlag der Österreichischen Akademie der Wissenschaften, 2011.

Németh, András. “A Mynas kódex és VII. Konstantin történeti kivonatgyűjteménye.” *Antik Tanulmányok* 55 (1 2011): 70–95.

Németh, András. “The Text of Apollonius Pictus : a critical transcription.” In *Apollonius Pictus : an illustrated late antique romance around 1000 ; facsimile edition of the historia Apollonii Regis Tyri (National Széchényi Library, Budapest, Cod. Lat. 4)*, eds. Anna Boreczky and András Németh. 153–174. Budapest: National Széchényi Library, 2011.

Németh, András. “Text versus Image? The illustrated Historia Apollonii : late Antique, Carolingian and Ottonian Times.” In *Apollonius Pictus : an illustrated late antique romance around 1000 ; facsimile edition of the historia Apollonii Regis Tyri (National Széchényi Library, Budapest, Cod. Lat. 4)*, eds. Anna Boreczky and András Németh. 75–95. Budapest: National Széchényi Library, 2011.

Németh, András. “Willibald Pirckheimer and his Greek codices from Buda.” *Gutenberg Jahrbuch* 86 (2011): 175–198.

- 3 Nenci, Elio, ed. *Baldi, Bernardino: In mechanica Aristotelis problemata exercitationes. Vol. 1: Testo latino riveduto e corretto con traduzione italiana a fronte. Vol. 2: Edizione anastatica*. Filosofia e scienza nell'età moderna. Milano: Franco Angeli, 2010.

- 4 Nenci, Elio, ed. *Bernardino Baldi's In mechanica Aristotelis problemata exercitationes*. Max Planck research library for the history and development of knowledge, sources ; 3. Berlin: epubli GmbH, 2011:
<http://www.edition-open-access.de/sources/3/index.html>

Nenci, Elio, ed. *Bernardino Baldi's In mechanica Aristotelis problemata exercitationes*. Versione italiana. Max Planck research library for the history and development of knowledge, sources ; 4. Berlin: epubli GmbH, 2011:
<http://www.edition-open-access.de/sources/4/index.html>

Neswald, Elizabeth. “Eigenwillige Objekte und widerspenstige Dinge : das Experimentieren mit Lebendigem in der Ernährungsphysiologie.” In *Affektive Dinge : Objektberührungen in Wissenschaft und Kunst*, eds. Natascha Adamowsky, Robert Felfe, Marco Formisano, Georg Toepfer, and Kirsten Wagner. 51–79. Göttingen: Wallstein, 2011.

Neven, Sylvie. “Through artist's recipe books : interest in and transmission of artists' knowledge ; observations and reflections within the Strasbourg tradition.” In *Transmission of artists' knowledge* (16 June 2011), eds. Mark Clarke, Bert De Munck, and Sven Dupré. 97–100. Brussel: KVAB, 2012.

Nordlund, Christer *see also Espmark and Nordlund*

- 5 Nordlund, Christer. *Hormones of life : endocrinology, the pharmaceutical industry, and the dream of a remedy for sterility, 1930–1970*. Sagamore Beach, MA: Science History Publications, 2011.

Nowacki, Horst. "Five decades of computer-aided ship design." *Computer-Aided Design : special issue* 42 (11 2010): 956–969.

Nowacki, Horst. "The heritage of Archimedes in ship hydrostatics : 2000 years from theories to applications." In *The genius of Archimedes : 23 centuries of influence on mathematics, science and engineering*, eds. Stephanos A. Paipetis and Marco Ceccarelli. 227–249. Dordrecht [u. a.]: Springer, 2010.

Nowacki, Horst. "Von Archimedes zu Bouguer, Euler und Chapman : Beitrag zum Sprechtag des Fachausschusses der STG 'Geschichte des Schiffbaus'" *Jahrbuch der Schiffbautechnischen Gesellschaft* 104 (2010).

Oertzen, Christine von *see also Allen and Oertzen*

Oertzen, Christine von. "Ausschluss und Aufbruch, transnational : Netzwerke und Fluchthilfe der akademischen weiblichen Weltgemeinschaft, 1933–1945." In *Das Geschlecht der Wissenschaften : zur Geschichte von Akademikerinnen im 19. und 20. Jahrhundert*, eds. Ulrike Auga, Claudia Bruns, Levke Harders, and Gabriele Jähnert. 183–202. Frankfurt/Main [u. a.]: Campus, 2010.

Oertzen, Christine von. "Flucht über Netzwerke : die Fluchthilfekorrespondenzen der International Federation of University Women." In *Alma Maters Töchter im Exil : zur Vertreibung von Wissenschaftlerinnen und Akademikerinnen in der NS-Zeit*, eds. Inge Hansen-Schaberg and Hiltrud Häntzschel. 97–113. München: Edition Text + Kritik, 2011.

- 1 Oertzen, Christine von. *Strategie Verständigung : zur transnationalen Vernetzung von Akademikerinnen 1917–1955*. Göttingen: Wallstein, 2012.

Oertzen, Christine von. "'Was ist Diskriminierung?' – Professorinnen ringen um ein hochschulpolitisches Konzept (1949–1989)." In *Zeitgeschichte als Geschlechtergeschichte : neue Perspektiven auf die Bundesrepublik*, eds. Julia Paulus, Eva-Maria Silies, and Kerstin Wolff. 103–118. Frankfurt/M. [u. a.]: Campus, 2012.

O'Malley, Maureen A. and Staffan Müller-Wille. "The cell as nexus : connections between the history, philosophy and science of cell biology." *Studies in History and Philosophy of Biological and Biomedical Sciences* 41 (3 2010): 169–171.

Omodeo, Pietro D. "Astronomia, filosofia e teologia nel tardo Rinascimento tedesco : Heinrich Julius di Braunschweig e il soggiorno di Giordano Bruno in Germania." *Giornale critico della filosofia italiana* 90 (2 2011): 307–326.

Omodeo, Pietro D. "Dante Alighieri : il 'genio nazionale'" In *Il nostro Gramsci : Antonio Gramsci a colloquio con i protagonisti della storia d'Italia*, ed. Angelo D'Orsi. 1–8. Roma: Viella, 2011.



1

Omodeo, Pietro D. “David Origanus’s planetary system (1599 and 1609).” *Journal for the History of Astronomy* 42 (4 2011): 439–454.

Omodeo, Pietro D. “Disputazioni cosmologiche a Helmstedt, Magnus Pegel e la cultura astronomica tedesca tra il 1586 ed il 1588.” *Galilaeana* 8 (2011): 133–158.

Omodeo, Pietro D. “Fato, amore e astrologia : uno scambio poetico tra Franscesco Giuntini e Alfonso Cambi Importuni.” *Zeitschrift für romanische Philologie* 127 (2 2011): 360–366.

Omodeo, Pietro D. “Helmstedt 1589 : wer exkommunizierte Giordano Bruno?” *Zeitschrift für Ideengeschichte* 5 (3 2011): 103–114.

Omodeo, Pietro D. “Nikolaus von Kues als Kopernikaner : sein Beitrag zur Astro-
nomie nach der Auffassung der Renaissance.” *Coincidentia* 2 (2 2011): 403–444.

Omodeo, Pietro D. “Perfection of the world and mathematics in late sixteenth-
century Copernican cosmologies.” In *The invention of discovery, 1500–1700*,
ed. James Dougal Fleming. 93–108. Farnham [u. a.]: Ashgate, 2011.

Omodeo, Pietro D. “Roberto Bellarmino : il grande inquisitore.” In *Il nostro Gramsci :
Antonio Gramsci a colloquio con i protagonisti della storia d’Italia*, ed. Angelo D’Orsi.
41–47. Roma: Viella, 2011.

Omodeo, Pietro D. “The German and European network of the professors of
mathematics at Helmstedt in the sixteenth century.” In *The circulation of science and
technology : proceedings of the 4th International Conference of the European Society
for the History of Science, Barcelona, 18–20 November 2010*, ed. Antoni Roca-Rosell.
294–301. Barcelona: Societat Catalana d’Història de la Ciència i de la Tècnica, 2012.

Omodeo, Pietro D. “Giordano Bruno nell’illuminismo radicale tedesco : la diatriba
historico-philosophica di Friedrich Christian Laukhard.” *Scienza e politica* 4
(2 2012): 306–323.

Omodeo, Pietro D. “Pandolfo Sfondrati : un atomista a Torino nel Cinquecento.”
Studi Piemontesi 41 (1 2012): 143–152.



Omodeo, Pietro D. “Renaissance science and literature : Benedetti, Ovid and the transformations of Phaeton’s myth after Copernicus.” *Science & Education* 21 (2012): 1–8.

Ortega, Francisco *see also Vidal and Ortega*

Ortega, Francisco. “Toward a genealogy of neuroascosis.” In *Neurocultures : glimpses into an expanding universe*, eds. Francisco Ortega and Fernando Vidal. 31–48. Frankfurt/M. [u. a.]: Lang, 2011.

Ortega, Francisco and Fernando Vidal. “Les (dés) espoirs du cerveau : neuroascèse et neuroéthique.” In *Les technologies de l’espoir : la fabrique d’une histoire à accomplir*, eds. Annette Leibing and Virginie Tournay. 259–281. Québec: Presses de l’Université Laval, 2010.

- 1 Ortega, Francisco and Fernando Vidal, eds. *Neurocultures : glimpses into an expanding universe*. Frankfurt/M. [u. a.]: Lang, 2011.

Ortega, Francisco and Rafaela Zorzaneli. “The cerebralization of fatigue : an analysis of the cerebral hypothesis in the case of chronic fatigue syndrome.” *História, ciências, saúde – Manguinhos* 17 (2 2010): 289–305:
<http://dx.doi.org/10.1590/S0104-59702010000200002>

Otis, Laura. “[Entries] ‘Schleiden’, ‘Schwann’” In *The world book encyclopedia. Vol. 17*. Chicago, IL: World book, Inc., 2010.

Otis, Laura. “Science surveys and histories of literature : reflections on an uneasy kinship.” *Isis* 101 (3 2010): 570–577.

Otis, Laura. “Natural neurons.” In *Eine Naturgeschichte für das 21. Jahrhundert : hommage à, zu Ehren von, in honor of Hans-Jörg Rheinberger*, 244–245. Berlin: Max-Planck-Institut für Wissenschaftsgeschichte, 2011.

Otis, Laura. “Das Prinzip Bewegung : Herz und Gehirn als Metaphern des menschlichen Lebens.” In *Der Mensch – Evolution, Natur und Kultur : Beiträge zu unserem heutigen Menschenbild*, ed. Jochen Oehler. 303–312. Berlin [u. a.]: Springer, 2011.

Pacheco, José M. *see also Fernández and Pacheco*

Pacheco, José M. *see also Mingarelli and Pacheco*

Pacheco, José M. “A forgotten little chapter on isoperimetric inequalities : on the fraction of a convex and closed plane area lying outside a circle with which it shares a diameter.” *Folia Canariensis Academiae Scientiarum* 20 (1–2 2010): 113–118.

Palmerino, Carla R. and Sophie Roux, eds. *Forms of mathematization (14th–17th centuries)*. Early Science and Medicine ; 15/4–5. Leiden: Brill, 2010.

Papoulias, Constantina and Felicity Callard. “The rehabilitation of the drive in neuropsychanalysis : from sexuality to self-preservation.” In *Freuds Referenzen*, eds. Christine Kirchoff and Gerhard Scharbert. 189–215. Berlin: Kulturverlag Kadmos, 2012.

Patiniotis, Manolis. “Eclecticism and appropriation of the new scientific methods by the Greek-speaking scholars in the Ottoman Empire.” In *Science between Europe and Asia : historical studies on the transmission, adoption and adaptation of knowledge*, eds. Feza Günergun and Dhruv Raina. 193–206. Dordrecht [u. a.]: Springer, 2011.

Patiniotis, Manolis and Kostas Gavroglu. “The sciences in Europe : transmitting centers and the appropriating peripheries.” In *The globalization of knowledge in history*, ed. Jürgen Renn. 321–343. Berlin: epubli GmbH, 2012:
http://www.edition-open-access.de/studies/1/chapter_17.html

- 2** Perlina, Anna. *Netzwerk Europa : europäische Öffentlichkeit im Zeitalter des Internets*. Saarbrücken: VDM Verlag Dr. Müller, 2010.

Peterson, Heather. “Fig of Hell.” In *Eine Naturgeschichte für das 21. Jahrhundert : hommage à, zu Ehren von, in honor of Hans-Jörg Rheinberger*, 60–61. Berlin: Max-Planck-Institut für Wissenschaftsgeschichte, 2011.

Plumb, Christopher. “‘In fact one cannot see it without laughing’ : the spectacle of the kangaroo in London, 1770–1830.” *Museum History Journal* 3 (1 2010): 7–32.

Podgorny, Irina *see also De Ceglia and Podgorny*

Podgorny, Irina *see also Kelly and Podgorny*

Podgorny, Irina. “Coleccionistas de arena : la comisión médico-quirúrgica italiana en el altiplano boliviano (1875–1877).” *Antípoda : Revista de Antropología y Arqueología de la Universidad de los Andes, Bogotá* 11 (2010): 165–188:
<http://antipoda.uniandes.edu.co/view.php/162/index.php?id=162>

- 3** Podgorny, Irina, ed. *Independencias y museos en América Latina*. L'ordinaire latino-américain, janvier-avril 2010 ; 212. Toulouse: IPEALT, 2010.

Podgorny, Irina. "Los médicos de muertos y la paleontología en el plata : medicina legal, cirugía militar y observación de campo en la obra de Francisco X. Muñiz, 1830–1850." *Anuario IEHS* 25 (2010): 305–332.

Podgorny, Irina. "Las momias de la Patria : entre el culto laico, la historia de la química y la higiene pública." *L'ordinaire latinoaméricain* 212 (2010): 53–74.

Podgorny, Irina. "Fronteras de papel : archivos, colecciones y la cuestión de límites en las naciones americanas." *Historia Crítica* 44 (2011): 56–79:
<http://dialnet.unirioja.es/servlet/articulo?codigo=3820734>

Podgorny, Irina. "El león de Hércules : Francisco X. Muñiz, Charles Darwin, Richard Owen y el género *Machairodus*." In *Darwin, el arte de hacer ciencia : las prensas de ciencias*, eds. Ana Barahona, Edna Suárez Díaz, and Hans-Jörg Rheinberger. 95–115. Mexico City: Universidad Nacional Autónoma de México, 2011.

Podgorny, Irina. "Mercaderes del pasado : Teodoro Vilardebó, Pedro de Angelis y el comercio de huesos y documentos en el Río de la Plata, 1830–1850." *Circumscribere* 9 (2011): 29 –77.

Podgorny, Irina. "Modern embalming, circulation of fluids, and the voyage through the human arterial system : Carl L. Barnes and the culture of immortality in America." *Nuncius* 26 (1 2011): 109–131.

Podgorny, Irina. "Neomylodon." In *Eine Naturgeschichte für das 21. Jahrhundert : hommage à, zu Ehren von, in honor of Hans-Jörg Rheinberger*, 101–103. Berlin: Max-Planck-Institut für Wissenschaftsgeschichte, 2011.

Podgorny, Irina. "Los reyes del Diluvio : la geología del cenozoico sudamericano en la década de 1880." *Publicación Especial / Asociación Paleontológica Argentina* 12 (2011): 21–34.

Podgorny, Irina. "Las rutas del saber : el tráfico de manuscritos iberoamericanos en la primera mitad del siglo XIX." In *Coleccionismos, prácticas de campo e representações*, eds. Maria Margaret Lopes and Alda Heizer. 47–60. Capina Grande: EDUEPB, 2011.

Podgorny, Irina. "'Silent and alone' : how the ruins of Palenque were taught to speak the language of archaeology." In *Comparative archaeologies : a sociological view of the science of the past*, ed. Ludomir R. Lozny. 527–553. New York [u. a.]: Springer, 2011.

Podgorny, Irina. "Changing the dead to statues of stone : the synthesis of fossils, petrification, photography, and the chemistry of the gorgonean arts." *Nuncius* 27 (2 2012): 289–308.

- 1 Podgorny, Irina. *Charlatanes : crónicas de remedios incurables*. Nuestra América. Buenos Aires: Eterna Cadencia, 2012.



Podgorny, Irina. “Los conejos de calabaza.” *20/10 historia : el mundo atlántico y la modernidad iberoamericana* (1 2012): 222–237.

Podgorny, Irina. “De cómo *Myiodon robustus* surgió de los huesos de *Glyptodon* : el comercio de huesos con el Río de la Plata y la sistemática de los mamíferos fósiles en 1840.” *Revista del Museo de La Plata : sección paleontología* 12 (67 2012): 43–64.

Podgorny, Irina. “Fossil dealers, the practices of comparative anatomy and British diplomacy in Latin America, 1820–1840.” *The British Journal for the History of Science* (2012): 1–28.

Podgorny, Irina. *Williams Flinders Petrie : un repositorio nacional para la ciencia y el arte*. Cuadernos de Museología. Bogotá: Universidad Nacional de Colombia, 2012.

Podgorny, Irina and Tatiana Kelly. “Faces drawn in the sand : a rescue project of native peoples’ photographs stored at the Museum of La Plata, Argentina.” *Microform & Imaging Review* 39 (3 2010): 98–113.

2 Pomata, Gianna, ed. *Oliva Sabuco de Nantes y Barrera: The true medicine. The other voice in early modern Europe : the Toronto series ; 4*. Toronto: Iter [u. a.], 2010.

Pomata, Gianna. “Sharing cases : the ‘observationes’ in early modern medicine.” *Early Science and Medicine* 15 (3 2010): 193–236.

Pomata, Gianna. “Observation rising : birth of an epistemic genre, 1500–1650.” In *Histories of scientific observation*, eds. Lorraine Daston and Elizabeth Lunbeck. 45–80. Chicago: University of Chicago Press, 2011.

Pomata, Gianna. “A word of the empirics : the ancient concept of observation and its recovery in early modern medicine.” *Annals of Science* 68 (1 2011): 1–25.

Pravica, Sandra. “Gaston Bachelard.” In *Bildtheorien aus Frankreich : ein Handbuch*, eds. Kathrin Busch and Iris Därmann. 15–22. München: Fink, 2011.

Pravica, Sandra. “Kerzenflamme.” In *Eine Naturgeschichte für das 21. Jahrhundert : hommage à, zu Ehren von, in honor of Hans-Jörg Rheinberger*, 162–164. Berlin: Max-Planck-Institut für Wissenschaftsgeschichte, 2011.

Presas i Puig, Albert. "Las relaciones científicas entre Alemania y España durante los años 20. Wissenschaftliche Beziehungen zwischen Deutschland und Spanien in den zwanziger Jahren." In *Traspasar fronteras : un siglo de intercambio científico entre España y Alemania. Über Grenzen hinaus : ein Jahrhundert deutsch-spanische Wissenschaftsbeziehungen*, ed. Sandra Rebok. 87–105. Madrid [u. a.]: Consejo Superior de Investigaciones Científicas [u. a.], 2010.

Raina, Dhruv. "The naturalization of modern science in South Asia : a historical overview of the processes of domestication of globalization." In *The globalization of knowledge in history*, ed. Jürgen Renn. 345–366. Berlin: epubli GmbH, 2012: http://www.edition-open-access.de/studies/1/chapter_18.html

Reinhardt, Carsten *see also Kant and Reinhardt*

Reinhardt, Carsten. "Habitus, Hierarchien und Methoden : „feine Unterschiede“ zwischen Physik und Chemie." *NTM* 19 (2 2011): 125–146.

Reinhardt, Carsten. "Smell." In *Eine Naturgeschichte für das 21. Jahrhundert : hommage à, zu Ehren von, in honor of Hans-Jörg Rheinberger*, 176–177. Berlin: Max-Planck-Institut für Wissenschaftsgeschichte, 2011.

Reinhardt, Carsten. "Massenspektroskopie als methodische Klammer des Instituts 1939–1978." In *100 Jahre Kaiser-Wilhelm-/ Max-Planck-Institut für Chemie (Otto-Hahn-Institut) : Facetten seiner Geschichte*, eds. Horst Kant and Carsten Reinhardt. 99–131. Berlin: Archiv der Max-Planck-Gesellschaft, 2012.

Reiß, Christian *see also Schlünder and Reiß*

Reiß, Christian. "Axolotl." In *Eine Naturgeschichte für das 21. Jahrhundert : hommage à, zu Ehren von, in honor of Hans-Jörg Rheinberger*, 132–134. Berlin: Max-Planck-Institut für Wissenschaftsgeschichte, 2011.

Reiß, Christian. "Gateway, instrument, environment : the aquarium as a hybrid space between animal fancying and experimental zoology." *NTM* 20 (4 2012): 309–336.

Reiß, Christian. "Wie die Zoologie das Füttern lernte : die Ernährung von Tieren in der Zoologie im 19. Jahrhundert." *Berichte zur Wissenschaftsgeschichte* 35 (4 2012): 286–299.

Ren, Xinguo, Patrick Rinke, Christian Joas, and Matthias Scheffler. "Random-phase approximation and its applications in computational chemistry and materials science." *Journal of Materials Science* 47 (21 2012): 7447–7471.

Renn, Jürgen *see also Blum and Renn*

Renn, Jürgen *see also Damerow and Renn*

Renn, Jürgen *see also Engler and Renn*

Renn, Jürgen *see also Fischer and Renn*

Renn, Jürgen *see also Hyman and Renn*

Renn, Jürgen *see also Lehner and Renn*

Renn, Jürgen *see also Wendt and Renn*

Renn, Jürgen. “Foreword: The historical epistemology of mechanics.” In *Galileo engineer*, ed. Matteo Valleriani. XI–XIV. Dordrecht [u. a.]: Springer, 2010.

Renn, Jürgen. “Galileis Revolution und die Transformation des Wissens.” In *Galileis erster Blick durchs Fernrohr und die Folgen heute*, ed. Jakob Staude. 9–29. Heidelberg: Universitätsverlag Winter, 2010.

Renn, Jürgen. “Globalization of knowledge.” *Research Perspectives of the Max Planck Society 2010+* (2010): 92–93. http://www.mpg.de/19449/Globalization_of_knowledge

Renn, Jürgen. “Komplementarität, nicht Konkurrenz.” In *Berlin – Hauptstadt für die Wissenschaft : Rückblick 2010*, ed. Michael Matthes. 24–25. Berlin: Kulturprojekte Berlin GmbH, 2010.

Renn, Jürgen. “Ong ay da de bi loi keo.” In *Max Planck – Ngươi khai sáng thuyet luong tu – Ky yeu mung sinh nhat thu 150 (1858–2008)*, eds. Pham Xuan Yem and Nguyen Xuan Xanh. 101–106. Ho Chi Minh City: Nhà Xuất Bản Tri Thức, 2010.

Renn, Jürgen. “Wie neue Weltbilder entstehen.” In *Wunderforschung : ein Experiment von Kindern, Wissenschaftlern und Künstlern*, eds. Katja Bödeker and Carmen Hammer. 35–41. Berlin: Nicolai, 2010.

Renn, Jürgen. “De globalisering van kennis in historisch perspectief.” *De Gids* 7 (2011): 828–848.

Renn, Jürgen. “Die Globalisierung des Wissens in der Geschichte.” In *Wem gehört das Wissen der Welt*, ed. Corinne Michaela Flick. 45–86. München [u. a.]: Convoco ! Edition, 2011. <http://www.convoco.co.uk/archive/eventdetail/19>

Renn, Jürgen. “Alle Wissenschaften haben einen gemeinsamen Ursprung’ [Interview].” *Technology Review* (2012): 1.



- 1 Renn, Jürgen, ed. *The globalization of knowledge in history*. Max Planck research library for the history and development of knowledge, studies ; 1. Berlin: epubli GmbH, 2012: <http://www.edition-open-access.de/studies/1/index.html>

Renn, Jürgen. “The globalization of knowledge in history.” In *Who owns the world’s knowledge?*, ed. Corinne Michaela Flick. 43–85. London: Convoco ! Edition, 2012.

- 2 Renn, Jürgen. *Sulle spalle di giganti e nani : la rivoluzione incompiuta di Albert Einstein*. Translated by Giuseppe Castagnetti. Saggi scienze. Torino: Bollati Boringhieri, 2012.

Renn, Jürgen. “Survey: Knowledge as a fellow traveler.” In *The globalization of knowledge in history*, ed. Jürgen Renn. 205–243. Berlin: epubli GmbH, 2012: http://www.edition-open-access.de/studies/1/chapter_12.html

Renn, Jürgen. “Survey: The place of local knowledge in the global community.” In *The globalization of knowledge in history*, ed. Jürgen Renn. 369–397. Berlin: epubli GmbH, 2012: http://www.edition-open-access.de/studies/1/chapter_19.html

Renn, Jürgen. “Über Netze, Bruchzonen und die Verbreitung von Wissen [Interview].” *Raumwissen* (1 2012): 38–43.

- 3 Renn, Jürgen and Peter Damerow. *The equilibrium controversy : Guidobaldo del Monte’s critical notes on the mechanics of Jordanus and Benedetti and their historical and conceptual background*. Max Planck research library for the history and development of knowledge, sources ; 2. Berlin: epubli GmbH, 2012: <http://www.edition-open-access.de/sources/2/index.html>
- 4 Renn, Jürgen and Peter Damerow. *Guidobaldo del Monte’s Mechanicorum liber*. Max Planck Research Library for the history and development of knowledge, sources ; 1. Berlin: epubli GmbH, 2010: <http://www.edition-open-access.de/sources/1/index.html>

Renn, Jürgen and Malcolm D. Hyman. “The globalization of knowledge in history : an introduction.” In *The globalization of knowledge in history*, ed. Jürgen Renn. 15–44. Berlin: epubli GmbH, 2012: http://www.edition-open-access.de/studies/1/chapter_4.html

Renn, Jürgen and Malcolm D. Hyman. "Survey: The globalization of modern science." In *The globalization of knowledge in history*, ed. Jürgen Renn. 561–604. Berlin: epubli GmbH, 2012.
http://www.edition-open-access.de/studies/1/chapter_27.html

Renn, Jürgen and Horst Kant. "Erfolge abseits des Mainstreams : ihre Voraussetzungen in Kaiser-Wilhelm- und Max-Planck-Gesellschaft ; Effizienz und der richtige Riecher." *Max Planck Journal Sonderausgabe* 2011 (4 2010): 3–3.

Renn, Jürgen and Horst Kant. "Éxito a contracorriente : estrategias de investigaciones en la sociedad Kaiser Wilhelm y en la Sociedad Max Planck." In *100 años de la JAE : la Junta para ampliación de estudios e investigaciones científicas en su centenario ; Actas del II congreso internacional, celebrado los días 4, 5 y 6 de febrero de 2008. Vol. 1*, eds. José Manuel Sánchez Ron and José García-Velasco. 446–461. Madrid: Residencia de Estudiantes, 2010.

Renn, Jürgen and Horst Kant. "Forschungserfolge : Strategien und ihre Voraussetzungen in Kaiser-Wilhelm-Gesellschaft und Max-Planck-Gesellschaft." In *Denkorte : Max-Planck-Gesellschaft und Kaiser-Wilhelm-Gesellschaft ; Brüche und Kontinuitäten 1911–2011*, eds. Peter Gruss and Reinhard Rürup. 70–78. Dresden: Sandstein Verlag, 2010.

Renn, Jürgen and Christoph Lehner. "Was bedeutet die Entdeckung der Higgs-Teilchen? [Interview]." *Cicero online* (2012): 1–2.

Renn, Jürgen and Simone Rieger. "Wie Wissen unsere Welt formt." In *Weltwissen : 300 Jahre Wissenschaften in Berlin*, eds. Jochen Hennig and Udo Andraschke. 34–39. München: Hirmer, 2010.

Renn, Jürgen and Matthias Schemmel. "Das Aufeinandertreffen zweier Wissenssysteme in Leben und Arbeit des Jesuitengelehrten Johannes Schreck." In *Die Kunst der Aufklärung : eine Ausstellung der Staatlichen Museen zu Berlin, der Staatlichen Kunstsammlungen Dresden, der Bayerischen Staatsgemäldesammlungen München und des National Museum of China*, 74–83. Berlin [u. a.]: Staatliche Museen zu Berlin [u.a.], 2011.

Renn, Jürgen, Matthias Schemmel, and Martin Thiering. "Plenary Agenda Report for Research Group E–II Space as transformed in the history of science : historical epistemology of space – experience and theoretical reflection in the historical development of spatial knowledge (Junior Research Group)." Reports of the Research Groups at the Topoi Plenary Session 2010 : special volume of: *eTopoi. Journal for Ancient Studies* 1 (2011): 1–11.

Renn, Jürgen and Matthias Schemmel. "Yesu hui xue zhe Deng Yuhan de sheng ping yu zhu zuo zhong suo ti xian de liang zhong zhi shi ti xi de xiang" In *Qi meng de yishu*, ed. Zhangshen Lü. 96–106. Beijing: Zhongguo she hui ke xue chu ban she, 2011.

Renn, Jürgen and Matthias Schemmel. "Das Aufeinandertreffen zweier Wissenssysteme in Leben und Arbeit des Jesuitengelehrten Johannes Schreck." In *Von mehr als einer Welt : die Künste der Aufklärung [Ausstellungskatalog, Kulturforum 10. Mai – 5. August 2012]*, eds. Moritz Wullen, Michael Lailach, and Jörg Völlnagel. 305–327. Petersberg: Imhof [u. a.], 2012.

Renn, Jürgen and Matthias Schemmel. "Theories of gravitation in the twilight of classical physics." In *Einstein and the changing worldviews of physics*, eds. Christoph Lehner, Jürgen Renn, and Matthias Schemmel. 3–22. Boston [u. a.]: Birkhäuser, 2012.

- 1 Renn, Jürgen, Robert Schlögl, and Hans-Peter Zenner, eds. *Herausforderung Energie : ausgewählte Vorträge der 126. Versammlung der Gesellschaft Deutscher Naturforscher und Ärzte e. V.* Max Planck Research Library for the history and development of knowledge : proceedings ; 1. Berlin: epubli GmbH, 2011:
<http://www.edition-open-access.de/proceedings/1f/index.html>

Rentetzi, Maria. "Box." In *Eine Naturgeschichte für das 21. Jahrhundert : hommage à, zu Ehren von, in honor of Hans-Jörg Rheinberger*, 36–38. Berlin: Max-Planck-Institut für Wissenschaftsgeschichte, 2011.

Rentetzi, Maria. "Stephanie Horowitz (1887–1942)." In *European women in chemistry*, eds. Jan Apotheker and Livia Simon Sarkadi. 75–79. Weinheim: Wiley-VCH, 2011.

Rentetzi, Maria. "Berta Karlik (1904–1990)." In *European women in chemistry*, eds. Jan Apotheker and Livia Simon Sarkadi. 161–164. Weinheim: Wiley-VCH, 2011.

Rheinberger, Hans-Jörg *see also Barahona, Suárez Díaz and Rheinberger*

Rheinberger, Hans-Jörg *see also Blum, Krois and Rheinberger*

Rheinberger, Hans-Jörg *see also Bredekamp and Rheinberger*

Rheinberger, Hans-Jörg *see also Epple, Hård, Nikolow and Rheinberger*

Rheinberger, Hans-Jörg *see also Hyder and Rheinberger*

Rheinberger, Hans-Jörg *see also Kranz, Quaderer and Rheinberger*

Rheinberger, Hans-Jörg *see also Mazzolini and Rheinberger*

Rheinberger, Hans-Jörg *see also Müller-Wille and Rheinberger*

Rheinberger, Hans-Jörg *see also Schierscher and Rheinberger*



Rheinberger, Hans-Jörg *see also Schmidgen and Rheinberger*

Rheinberger, Hans-Jörg. “The art of exploring the unknown : views on contemporary research in the life sciences.” In *Science as cultural practice. Vol. 1: Cultures and politics of research from the early modern period to the age of extremes*, eds. Moritz Epple and Klaus Zittel. 141–151. Berlin: Akademie Verlag, 2010.

Rheinberger, Hans-Jörg. “Berlin – Tübingen : das Max-Planck-Institut für Biologie.” In *Denkorte : Max-Planck-Gesellschaft und Kaiser-Wilhelm-Gesellschaft ; Brüche und Kontinuitäten 1911–2011*, eds. Peter Gruss and Reinhard Rürup. 204–213. Dresden: Sandstein Verlag, 2010.

Rheinberger, Hans-Jörg. “Bilder als Erkenntnismittel : Laudatio auf Julia Voss (Sigmund-Freud-Preis für wissenschaftliche Prosa 2009).” In *Deutsche Akademie für Sprache und Dichtung : Jahrbuch 2009*, 159–162. Göttingen: Wallstein, 2010.

Rheinberger, Hans-Jörg. “Biologie in Berlin um 1900.” In *Transformation der Wissensordnung*, ed. Heinz-Elmar Tenorth. 735–775. Berlin: Akademie Verlag, 2010.

- 2** Rheinberger, Hans-Jörg. *An epistemology of the concrete : twentieth-century histories of life*. Experimental futures. Durham [u. a.]: Duke University Press, 2010.

Rheinberger, Hans-Jörg. “Evolution in Natur und Kultur.” In *Wer hat die Deutungshoheit über die Evolution? Streitgespräche in den Wissenschaftlichen Sitzungen der Versammlung der Berlin-Brandenburgischen Akademie der Wissenschaften am 21. November 2008 und am 26. Juni 2009*, 119–120. Berlin: Berlin-Brandenburgische Akademie der Wissenschaften, 2010.

Rheinberger, Hans-Jörg. “[Entry] ‘Experimentalsysteme’” In *Enzyklopädie Philosophie. Vol. 1*, eds. Hans Jörg Sandkühler, Volker Schürmann, and Pirmin Stekeler-Weithofer. 676–681. 2. Auflage. Hamburg: Meiner, 2010.

Rheinberger, Hans-Jörg. “Historische Epistemologie.” In *Von der Arbeit des Historikers : ein Wörterbuch zu Theorie und Praxis der Geschichtswissenschaft*, eds. Anne Kwaschik and Mario Wimmer. 103–105. Bielefeld: Transcript, 2010.

Rheinberger, Hans-Jörg. “Introduction to ‘Writing genomics’” *History and Philosophy of the Life Sciences* 32 (1 2010): 63–65.

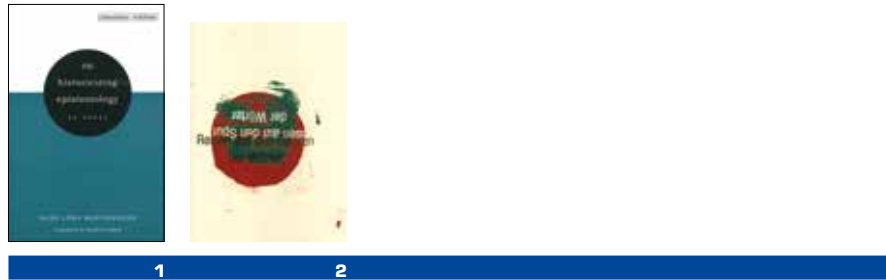

Rheinberger, Hans-Jörg. “Eine kurze Geschichte des Museums für Naturkunde zu Berlin.” In *Vorstoss ins Innere : Streifzüge durch das Berlin Museum für Naturkunde*, eds. Ulrich Moritz, Agnieszka Pufelska, and Hanns Zischler. 55–58. Berlin: Alpheus Verlag, 2010.

Rheinberger, Hans-Jörg. “[Abstract] Molecular biology : a paradigm of the 20th century science – On the nature of disciplines and on cultures of emergence.” In *The future of knowledge : mapping interfaces ; interdisciplinary workshop report, Reykjavik, 16–17 June 2009*, eds. Ulrike Landfester and Gisli Pálsson. 14. Strasbourg: European Science Foundation, 2010.

Rheinberger, Hans-Jörg. “Molekulare Modelle als epistemische Objekte : Ribosomen im Spiegel von 50 Jahren Forschung.” In *Weltwissen : 300 Jahre Wissenschaften in Berlin*, eds. Jochen Hennig and Udo Andraschke. 76–81. München: Hirmer, 2010.

Rheinberger, Hans-Jörg. “Mutige Schritte.” In *Der offene Blick : 10 Jahre Kunstmuseum Lichtenstein*, ed. Friedemann Malsch. 44. [Sulgen]: Benteli, 2010.

- 1 Rheinberger, Hans-Jörg. *On historicizing epistemology : an essay*. Translated by David Fernbach. Cultural memory in the present. Stanford: Stanford University Press, 2010.

Rheinberger, Hans-Jörg. “On the historicity of scientific knowledge : Ludwik Fleck, Gaston Bachelard, Edmund Husserl.” In *Science and the life-world : essays on Husserl’s ‘Crisis of the European sciences’*, eds. David Hyder and Hans-Jörg Rheinberger. 164–176. Stanford, Ca.: Stanford University Press, 2010.

Rheinberger, Hans-Jörg. “Recent orientations and reorientations in the life sciences.” In *Science in the context of application*, eds. Martin Carrier and Alfred Nordmann. 161–168. Dordrecht: Springer, 2010.

- 2 Rheinberger, Hans-Jörg. *Reisen auf den Spuren der Wörter : Gedichte von Hans Jörg Rheinberger. [Siebdrucke und Digitalgrafik von Kasia Lewandowska und Wol Müller. CD: Improvisationen für Klavier von Kasia Lewandowska]*. Sulzbach [u. a.]: Alpha-Presse [u.a.], 2010.

Rheinberger, Hans-Jörg. “Vignette für W. H.” In *Babel : für Werner Hamacher*, ed. Aris Fioretos. 314–315. Basel [u. a.]: Engeler, 2010.

Rheinberger, Hans-Jörg. “Was bleibt vom Darwin-Jahr 2009? Entdeckt wurde nur ein Ei, aber der Ertrag des Jubiläums ist erstaunlich ; eine Graswurzelbewegung.” *Frankfurter Allgemeine Zeitung*, 07.04. 2010, N5.

Rheinberger, Hans-Jörg. “Was wir noch von Darwin lernen können : eine Rückschau auf das Darwin-Jahr 2009.” *Nach Feierabend : Zürcher Jahrbuch für Wissensgeschichte* 6 (2010): 163–169.

Rheinberger, Hans-Jörg. “Consistency from the perspective of an experimental systems approach to the sciences and their epistemic objects.” *Revista Internacional de Filosofia* 34 (1 2011): 307–321.

Rheinberger, Hans-Jörg. “Darstellung als Grundproblem.” In *Wirkungsmaschine Schauspieler : vom Menschendarsteller zum multifunktionalen Spielmacher*, eds. Anton Rey, Hajo Kurzenberger, and Stephan Müller. 138–143. Berlin: Alexander Verlag, 2011.

Rheinberger, Hans-Jörg. “Darwin, ‘Diversität’ und Evolution : ein historisches Aperçu.” In *Evolution : Theorie, Formen und Konsequenzen eines Paradigmas in Natur, Technik und Kultur*, eds. Volker Gerhardt, Klaus Lucas, and Günter Stock. 89–94. Berlin: Akademie Verlag, 2011.

Rheinberger, Hans-Jörg. “Disziplinen im Fluss.” *attempto!* (Mai 2011): 8–11.

Rheinberger, Hans-Jörg. “Entre falso tabú y falsa esperanza : una mirada a la herencia a 200 años del nacimiento de Darwin.” In *Darwin, el arte de hacer ciencia : las prensas de ciencias*, eds. Ana Barahona, Edna Suárez Díaz, and Hans-Jörg Rheinberger. 75–80. Mexico City: Universidad Autónoma de Mexico, 2011.

Rheinberger, Hans-Jörg. “Geleitwort.” In *Von Molekülen zu Zellen : 100 Jahre experimentelle Biologie ; Betrachtungen eines Biochemikers*, ed. Ernst J. M. Helmreich. 9–9. Diepholz [u. a.]: GNT-Verlag, 2011.

Rheinberger, Hans-Jörg. “Infra-experimentality : from traces to data, from data to patterning facts.” *History of Science* 49 (3 2011): 337–348.

Rheinberger, Hans-Jörg. “Kolumne : über den Kolumbus-Effekt.” *Wirtschaft regional für Liechtenstein, Werdenberg, Sarganserland und Rheintal : Jahresmagazin* (2011): 5.

Rheinberger, Hans-Jörg. “Pfropfen in Experimentalsystemen.” In *Pfropfen, Impfen, Transplantieren*, ed. Uwe Wirth. 65–74. Berlin: Kulturverlag Kadmos, 2011.

Rheinberger, Hans-Jörg. “Riskante Vernunft : produktive Spannung zwischen Kunst und Wissenschaft bei Paul Vanouse = Risking reason : the productive tension of art and science in the work of Paul Vanouse.” In *Paul Vanouse – Fingerprints ... : Index – Abdruck – Spur*, ed. Jens Hauser. 87–104. Berlin: Argobooks, 2011.

Rheinberger, Hans-Jörg. "Die Sprache der Wissenschaft : zwischen Normierung und epistemischer Dingwelt." In *Welche Sprache(n) spricht die Wissenschaft? Streitgespräche in den Wissenschaftlichen Sitzungen der Versammlung der Akademie-mitglieder am 2. Juli und am 26. November 2010*, 89–91. Berlin: Berlin-Brandenburgische Akademie der Wissenschaften, 2011.

Rheinberger, Hans-Jörg. "Vom Schreiben, ohne zu wissen, wie es endet [Interview]." In *Geschichte als Passion : über das Entdecken und Erzählen der Vergangenheit ; zehn Gespräche*, eds. Alexander Kraus and Birte Kohtz. 266–291. Frankfurt/M. [u. a.]: Campus, 2011.

Rheinberger, Hans-Jörg. "Alte Realschule Vaduz." In *Album für Robert Allgäuer 75*, eds. Claudine Kranz, Hansjörg Quaderer, and Hans-Jörg Rheinberger. Bl. 57–58. Frankfurt am Main [u. a.]: Stroemfeld, 2012.

Rheinberger, Hans-Jörg. "Auf Seitenpfaden zur Erkenntnis' : Interview." *Magazin / Universität Zürich* 21 (3 2012): 36–38:
<http://www.kommunikation.uzh.ch/publications/magazin.html>

Rheinberger, Hans-Jörg. "Biologie – mit System neu definiert." *Max-Planck-Forschung* (1 2012): 12–16: www.mpg.de/5764521/W001_Zur-Sache_012-016.pdf

Rheinberger, Hans-Jörg. "Diskussion 'Über das Ausblenden.'" In *Potentiale des Vergessens*, eds. André L. Blum, Theresa Georgen, Wolfgang Knapp, and Veronika Sellier. 291–297. Würzburg: Königshausen & Neumann, 2012.

Rheinberger, Hans-Jörg. "Epistemisches Ding und Verkörperung." In *Verkörperungen*, eds. André L. Blum, John Michael Krois, and Hans-Jörg Rheinberger. 3–9. Berlin: Akademie Verlag, 2012.

Rheinberger, Hans-Jörg. "Experiment, Forschung, Kunst." *Dramaturgie* (2 2012): 9–12.

Rheinberger, Hans-Jörg. "Experimental systems : difference, graphematicity, conjuncture." In *Intellectual birdhouse : artistic practice as research*, eds. Florian Dombois, Ute Meta Bauer, Claudia Mareis, and Michael Schwab. 89–99. Köln [u. a.]: König, 2012.

Rheinberger, Hans-Jörg. "Geleitwort." In *Alfred Kühn (1885 bis 1968) : ein Forscherleben*, ed. Reinhard Mocek. 9–10. Rangsdorf: Basilisken-Presse, 2012.

Rheinberger, Hans-Jörg. "Genesis of knowledge spaces and objects of knowledge." In *Rethinking epistemology. Vol. 1*, eds. Günter Abel and James Conant. 287–299. Berlin [u. a.]: de Gruyter, 2012.

Rheinberger, Hans-Jörg. “Internationalism and the history of molecular biology.” In *The globalization of knowledge in history*, ed. Jürgen Renn. 737–744. Berlin: epubli GmbH, 2012: http://www.edition-open-access.de/studies/1/chapter_32.html

Rheinberger, Hans-Jörg. “Die Mehlmotte.” In *Zoologicon : ein kulturhistorisches Wörterbuch der Tiere*, eds. Christian Kassung, Jasmin Mersmann, and Olaf B. Rader. 258–262. Paderborn: Fink, 2012.

Rheinberger, Hans-Jörg. “[Abstract] On epistemic objects.” In *The challenge of the object = Die Herausforderung des Objekts : 33rd congress of the International Committee of the History of Art, Nuremberg, 15th–20th July 2012*, eds. G. Ulrich Großmann and Petra Krutisch. 156–156. Nürnberg: Germanisches Nationalmuseum, 2012.

Rheinberger, Hans-Jörg. “A plea for a historical epistemology of research.” *Journal for General Philosophy of Science* 43 (1 2012): 105–111.

Rheinberger, Hans-Jörg. “A revolution in biology?” In *Differing routes to stem cell research : Germany and Italy*, eds. Renato G. Mazzolini and Hans-Jörg Rheinberger. 13–15. Bologna [u. a.]: Società editrice il Mulino [u. a.], 2012.

Rheinberger, Hans-Jörg. “Die Sprachen der Wissenschaftsgeschichte.” In *Fachsprachen und Normalsprache*, eds. Julia Voss and Michael Stolleis. 77–83. Göttingen: Wallstein, 2012.

Rheinberger, Hans-Jörg. “Über das Ausblenden.” In *Potentiale des Vergessens*, eds. André L. Blum, Theresa Georgen, Wolfgang Knapp, and Veronika Sellier. 287–290. Würzburg: Königshausen & Neumann, 2012.

Rheinberger, Hans-Jörg. “Das Wesen der Forschung besteht im Übersteigen von Grenzen’ : ein Gespräch mit Wolfert von Rahden über historische und aktuelle Grenzverläufe der Wissenschaften.” *Gegenworte* 27 (2012): 38–42.

Rheinberger, Hans-Jörg. “Wissenschaft und Experiment.” In *Autorität des Wissens : Kunst- und Wissenschaftsgeschichte im Dialog*, 123–132. Zürich: Diaphanes, 2012.

Rheinberger, Hans-Jörg. “Zettelwirtschaft.” In *Schreiben als Kulturtechnik*, ed. Sandro Zanetti. 441–452. Berlin: Suhrkamp, 2012.

Rheinberger, Hans-Jörg. “Ein Zweig aus dem Garten.” In *Über das Kolleg hinaus : Joachim Nettelbeck, dem Sekretär des Wissenschaftskollegs 1981 bis 2012*, eds. Mamadou Diawara, Klaus Günther, and Reinhart Meyer-Kalkus. 278–279. Berlin: Wissenschaftskolleg zu Berlin, 2012.

Rheinberger, Hans-Jörg, Jens Hauser, and Ingeborg Reichle. “Synthetisch : Biologie und Kunst ; die Technisierung des Lebendigen und die Verlebendigung von Technik ;



Ingeborg Reichle im Gespräch mit Hans-Jörg Rheinberger und Jens Hauser.” In *Die Akademie am Gendarmenmarkt : Jahresmagazin 2011/12*, ed. Günter Stock. 41–45. Berlin: Berlin-Brandenburgische Akademie der Wissenschaften, 2011.

Rheinberger, Hans-Jörg, Karin Krauthausen, and Omar W. Nasim. “Papierpraktiken im Labor : Interview mit Hans-Jörg Rheinberger.” In *Notieren, Skizzieren : Schreiben und Zeichnen als Verfahren des Entwurfs*, eds. Karin Krauthausen and Omar W. Nasim. 139–158. Zürich [u. a.]: Diaphanes, 2010.

Rickles, Dean *see also DeWitt and Rickles*

Rickles, Dean. “Quantum gravity meets &HPS.” In *Integrating history and philosophy of science : problems and prospects*, eds. Seymour Mauskopf and Tad Schmaltz. 163–199. Dordrecht [u. a.]: Springer, 2012.

Rieger, Simone *see Renn and Rieger*

- 1 Righini Bonelli, Maria L. and William R. Shea, eds. *Reason, experiment and mysticism in the scientific revolution*. New York: Science History Publications, 2012.

Roelcke, Volker. “Auf der Suche nach der Politik in der Wissensproduktion : Plädoyer für eine historisch-politische Epistemologie.” *Berichte zur Wissenschaftsgeschichte* 33 (2 2010): 176–192.

Roosth, Sophia. “Coral Reef.” In *Eine Naturgeschichte für das 21. Jahrhundert : hommage à, zu Ehren von, in honor of Hans-Jörg Rheinberger*, 20–21. Berlin: Max-Planck-Institut für Wissenschaftsgeschichte, 2011.

Roux, Sophie *see also Bour and Roux*

Roux, Sophie *see also Chabot and Roux*

Roux, Sophie *see also Goffi and Roux*

Roux, Sophie *see also Ierodiakonou and Roux*

Roux, Sophie *see also Palmerino and Roux*

Roux, Sophie. "L'essai de logique de Mariotte : une naturalisation de la méthode?" In *Lambertiana : hommage à Jacques Lambert*, eds. Pierre Edouard Bour and Sophie Roux. 163–188. Paris: Vrin, 2010.

Roux, Sophie. "Forms of mathematization (14th–17th centuries)." *Early Science and Medicine* 15 (4–5 2010): 319–337.

Roux, Sophie. "Histoire de la science classique et historicité des sciences chez Meyerson." In *L'histoire et la philosophie des sciences à la lumière de l'œuvre d'Émile Meyerson (1859–1933)*, eds. Eva Telkes-Klein and Elhanan Yakira. 91–114. Paris: Champion, 2010.

Roux, Sophie. "Meyerson et les mathématiques." *Corpus : revue de philosophie* 58 (2010): 23–46.

Roux, Sophie. "Quelles mathématiques pour la force de percussion?" In *Mathématiques et connaissance du monde réel avant Galilée*, ed. Sabine Rommevaux. 243–285. Montreuil: Omniscience, 2010.

Roux, Sophie. "The emergence of the notion of thought experiments." In *Thought experiments in historical and methodological context*, eds. Katerina Ierodiakonou and Sophie Roux. 1–33. Leiden [u. a.]: Brill, 2011.

- 2 Roux, Sophie. *L'essai de logique de Mariotte : archéologie des idées d'un savant ordinaire*. Histoire et philosophie des sciences ; 2. Paris: Garnier, 2011.

Roux, Sophie. "Exact experiences and mathematical deductions : physics according to Mariotte." In *Departure for modern Europe : a handbook of early modern philosophy (1400–1700)*, ed. Hubertus Busche. 715–733. Hamburg: Meiner, 2011.

Roux, Sophie. "Pour une étude des formes de la mathématisation." In *La mathématisation comme problème*, eds. Hugues Chabot and Sophie Roux. 3–38. Paris: Edition des archives contemporaines, 2011.

Roux, Sophie. "Logique and méthode au XVIIe siècle." *Cahiers philosophiques de Strasbourg : numéro spécial 'La science et sa logique'* 32 (2012): 21–46.

Sachse, Carola *see also Fengler and Sachse*

Sachse, Carola. "Bedingte Umbrüche : Überlegungen zum Verhältnis von Wissenschaft und Politik in der westdeutschen Nachkriegszeit." In *Die Deutsche Forschungsgemeinschaft 1920–1970 : Forschungsförderung im Spannungsfeld von Wissenschaft und Politik*, eds. Karin Orth and Willi Oberkrome. 36–52. Stuttgart: Steiner, 2010.

Sachse, Carola. "Kaiser-Wilhelm-Institut für Anthropologie, menschliche Erblehre und Eugenik Berlin." In *Denkorte : Max-Planck-Gesellschaft und Kaiser-Wilhelm-*

Gesellschaft ; Brüche und Kontinuitäten 1911–2011, eds. Peter Gruss and Reinhard Rürup. 230–238. Dresden: Sandstein Verlag, 2010.

Sachse, Carola. “‘Apology, responsibility, memory’ : coming to terms with Nazi medical crimes – The Example of the Max Planck Society.” *European Archives of Psychiatry and Clinical Neuroscience* 261 (2 2011): 202–206.

Sachse, Carola. “Ein ‘als Neugründung zu deutender Beschluß...’ : vom Kaiser-Wilhelm-Institut für Anthropologie, menschliche Erblehre und Eugenik zum Max-Planck-Institut für molekulare Genetik.” *Medizinhistorisches Journal* 46 (1 2011): 24–50.

Sachse, Carola. “Was bedeutet eine Entschuldigung? Die Überlebenden medizinischer NS-Verbrechen und die Max-Planck-Gesellschaft.” In *Politische Gewalt und Machtausübung im 20. Jahrhundert : Zeitgeschichte, Zeitgeschehen und Kontroversen ; Festschrift für Gerhard Botz*, eds. Heinrich Berger, Melanie Dejnega, Regina Fritz, and Alexander Prenninger. 631–649. Wien [u. a.]: Böhlau, 2011.

Sachse, Carola. “Was bedeutet ‘Entschuldigung’? Die Überlebenden medizinischer NS-Verbrechen und die Max-Planck-Gesellschaft.” *Berichte zur Wissenschaftsgeschichte* 34 (3 2011): 224–241.

Sachse, Carola. “Einleitung.” In *Kernforschung in Österreich : Wandlungen eines interdisziplinären Forschungsfeldes 1900–1978*, eds. Silke Fengler and Carola Sachse. 9–46. Wien [u. a.]: Böhlau, 2012.

Sachse, Carola. “Wissenschaft und Geschlecht in der NS-Medizin : Überlegungen zur Verbindung wissenschafts- und geschlechterhistorischer Untersuchungsansätze.” In *Geschlecht und ‘Rasse’ in der NS-Medizin*, eds. Insa Eschebach and Astrid Ley. 17–27. Berlin: Metropol, 2012.

Sachse, Carola and Mark Walker. “Naturwissenschaften, Krieg und Systemverbrechen : die Kaiser-Wilhelm-Gesellschaft im internationalen Vergleich 1933–1945.” In *Gebrochene Wissenschaftskulturen : Universität und Politik im 20. Jahrhundert*, eds. Michael Grüttner, Rüdiger Hachtmann, Konrad H. Jarausch, Jürgen John, Matthias Middell, John Jürgen, and Middell Matthias. 167–182. Göttingen: Vandenhoeck & Ruprecht, 2010.

Saifer, Neil. “Global knowledge on the move : itineraries, Amerindian narratives, and deep histories of science.” *Isis* 101 (1 2010): 133–145.

Salisbury, Donald C. *see also Blum, Renn and Salisbury*

Salisbury, Donald C. “Peter Bergmann and the invention of constrained Hamiltonian dynamics.” In *Einstein and the changing worldviews of physics*, eds. Christoph Lehner, Jürgen Renn, and Matthias Schemmel. 247–257. Boston [u. a.]: Birkhäuser, 2012.



- 1 Schäfer, Dagmar, ed. *Gong ting yu di fang : shi qi zhi shi ba shi ji de ji shu jiao liu*. Beijing: Zi jin cheng chu ban she, 2010.

Schäfer, Dagmar. “Historical perspectives on Chinese metallurgy. Essay review of: Needham, Joseph: Science and civilisation in China, vol. 5. Chemistry and chemical technology, part 11: ferrous metallurgy, ed. by Donald B. Wagner. Cambridge: Cambridge University Press 2008.” *Metascience* 19 (3 2010): 479–482.

Schäfer, Dagmar. “Staunen und Forschen in wunderlichen Welten.” In *Wunderforschung : ein Experiment von Kindern, Wissenschaftlern und Künstlern*, eds. Katja Bödeker and Carmen Hammer. 118–121. Berlin: Nicolai, 2010.

Schäfer, Dagmar. “Technologie und Innovation im vormodernen China : ein historischer Überblick.” *Ferrum* 82 (2010): 15–24.

- 2 Schäfer, Dagmar. *The crafting of the 10.000 things : knowledge and technology in 17th century China*. Chicago [u. a.]: The University of Chicago Press, 2011.

Schäfer, Dagmar, ed. *Cultures of knowledge : technology in Chinese history*. Sinica Leidensia ; 103. Leiden [u. a.]: Brill, 2012.

Schäfer, Dagmar. “Inscribing the artifact and inspiring trust : the changing role of markings in the Ming Era.” *East Asian Science, Technology and Society* 5 (2 2011): 239–265.

- 3 Schäfer, Dagmar. “Silken strands : making technology work in China.” In *Cultures of knowledge : technology in Chinese history*, ed. Dagmar Schäfer. 45–73. Leiden [u. a.]: Brill, 2012.

- 4 Scharf, Peter M. and Malcolm D. Hyman. *Linguistic issues in encoding Sanskrit*. Providence: The Sanskrit Library, 2010.

Schemmel, Matthias *see also Blum, Renn, Salisbury and Schemmel*

Schemmel, Matthias *see also Lehner, Renn and Schemmel*

Schemmel, Matthias *see also Renn and Schemmel*



Schemmel, Matthias. “Thomas Harriot as an English Galileo : the force of shared knowledge in early modern mechanics.” In *Thomas Harriot and his world : mathematics, exploration, and natural philosophy in early modern England*, ed. Robert Fox. 89–111. Farnham [u. a.]: Ashgate, 2012.

Schemmel, Matthias. “The transmission of scientific knowledge from Europe to China in the early modern period.” In *The globalization of knowledge in history*, ed. Jürgen Renn. 269–293. Berlin: epubli GmbH, 2012:
http://www.edition-open-access.de/studies/1/chapter_14.html

Schickore, Jutta and Theodore Arabatzis, eds. *Perspectives on Science : special issue, vol. 20/4*. Cambridge, Mass.: MIT Press, 2012.

- 1 Schierscher, Hanni and Hans-Jörg Rheinberger. *Ohne Titel, 2011 ('Iris')*. Positionen & Diskurse, eds. Cornelia Wolf and Laura Hilti. Schaan: Schichtwechsel, 2012.

Schirmmacher, Arne. “Looking into (the) matter : scientific artifacts and atomistic iconography.” In *Illuminating instruments*, eds. Peter John T. Morris and Klaus B. Staubermann. 131–155. Washington D.C.: Smithsonian Institution Scholarly Press, 2010.

- 2 Schirmmacher, Arne, ed. *Philipp Lenard : Erinnerungen eines Naturforschers ; kritische annotierte Ausgabe des Originaltyposkriptes von 1931/1943*. Berlin [u. a.]: Springer, 2010.

Schirmmacher, Arne. “‘Theoretiker’ zwischen mathematischer und experimenteller Physik – Zu Max Plancks Stil physikalischen Argumentierens.” In *Max Planck und die moderne Physik*, ed. Dieter Hoffmann. 35–48. Berlin: Springer, 2010.

Schirmmacher, Arne. “From ‘Kosmos’ to ‘Koralle’ : on the culture of science reading in Imperial and Weimar Germany.” In *Weimar culture and quantum mechanics : selected papers by Paul Forman and contemporary perspectives on the Forman thesis*, eds. Cathryn Carson, Alexei B. Kojevnikov, and Helmuth Trischler. 433–452. London [u. a.]: Imperial College Press [u. a.], 2011.

Schirmmacher, Arne. “Ein Leben in Experimenten : Philipp Lenard zwischen Naturforschertum und moderner Physik.” In *Konstruierte Wirklichkeit : Philipp*

Lenard 1862–1947 ; Biografie, Physik, Ideologie, eds. Wilhelm Füßl and Johannes-Geert Hagmann. 18–27. München: Deutsches Museum, 2012.

Schirmacher, Arne. “Ein physikalisches Konzil : wie die Solvay-Konferenz und das Solvay-Institut vor hundert Jahren nicht nur der Quantenmechanik zum Durchbruch verhalfen.” *Physik-Journal* 11 (1 2012): 39–42.

Schirmacher, Arne. “Popular science between news and education : a European perspective.” *Science & Education* 21 (3 2012): 289–291.

Schirmacher, Arne. “State-controlled multimedia education for all? Science programs in early German radio.” *Science & Education* 21 (3 2012): 381–401.

- 3 Schlich, Thomas. *The origins of organ transplantation : surgery and laboratory science, 1880–1930*. Rochester studies in medical history. Rochester, NY: University of Rochester Press, 2010.

Schlich, Thomas. “Die perfekte Maschine : die Rationalisierung der Knochenbruchbehandlung im Ersten Weltkrieg durch Lorenz Böhler.” In *Lorenz Böhler : Pionier der modernen Unfallmedizin*, ed. Thomas Feurstein. 116–172. Graz [u.a.]: Neugebauer, 2010.

Schlich, Thomas. “The technological fix and the modern body : surgery as a paradigmatic case.” In *The cultural history of the human body. Vol. 6: In the modern age*, ed. Ivan Crozier. 71–92. Oxford [u.a.]: Berg, 2010.

Schlich, Thomas. “Antisepsis and asepsis : clean surgery.” In *Great discoveries in medicine*, eds. William F. Bynum and Helen Bynum. 222–227. London: Thames & Hudson, 2011.

Schlich, Thomas. “Hip replacement : new for old.” In *Great discoveries in medicine*, eds. William F. Bynum and Helen Bynum. 252–255. London: Thames & Hudson, 2011.

Schlich, Thomas. “Invasive microbes.” In *Eine Naturgeschichte für das 21. Jahrhundert : hommage à, zu Ehren von, in honor of Hans-Jörg Rheinberger*, 239–241. Berlin: Max-Planck-Institut für Wissenschaftsgeschichte, 2011.

Schlich, Thomas. “Keyhole surgery : through the looking glass.” In *Great discoveries in medicine*, eds. William F. Bynum and Helen Bynum. 256–257. London: Thames & Hudson, 2011.

Schlich, Thomas. “Transplant surgery : diseases and organs, self and non-self.” In *Great discoveries in medicine*, eds. William F. Bynum and Helen Bynum. 246–251. London: Thames & Hudson, 2011.

Schlich, Thomas. "Asepsis and bacteriology : a realignment of surgery and laboratory science." *Medical History* 56 (3 2012): 308–334.

Schlünder, Martina. "Wissens-Hunger im Stall : die Entstehung von Knochen-Schafen als Versuchstiere in der Unfallchirurgie." *Berichte zur Wissenschaftsgeschichte* 35 (4 2012): 322–340.

Schlünder, Martina, Christian Reiß, Axel C. Hüntelmann, and Susanne Bauer, eds. *Cakes and candies – Zur Geschichte der Ernährung von Versuchstieren*. *Berichte zur Wissenschaftsgeschichte* ; 35/4. Special journal issue. Weinheim: Wiley-VCH, 2012.

Schmidgen, Henning *see also* Azzouni, Brandt, Gausemeier, Kursell and Schmidgen

Schmidgen, Henning. "1900 – The Spectatorium : on biology's audiovisual archive." *Grey Room* 43 (Spring 2011): 42–65.

Schmidgen, Henning. "Barcola." In *Eine Naturgeschichte für das 21. Jahrhundert : hommage à, zu Ehren von, in honor of Hans-Jörg Rheinberger*, 23–25. Berlin: Max-Planck-Institut für Wissenschaftsgeschichte, 2011.

Schmidgen, Henning. "Passagenwerk 1850 : Bild und Zahl in den physiologischen Zeitexperimenten von Hermann von Helmholtz." *Berichte zur Wissenschaftsgeschichte* 34 (2 2011): 139–155.

Schmidgen, Henning. "Cinematography without film : architectures and technologies of visual instruction in biology around 1900." In *The educated eye : visual culture and pedagogy in the life sciences*, eds. Nancy Anderson and Michael R. Dietrich. 94–120. Hanover, N.H.: Dartmouth College Press, 2012.

Schmidgen, Henning and Hans-Jörg Rheinberger. "Circulations : a virtual laboratory and its elements." *Circumscribere* 8 (2010): 1–11:
<http://revistas.pucsp.br/index.php/circumhc/article/view/3079/1997>

Schöttler, Peter *see also* Gosewinkel and Schöttler

Schöttler, Peter. "After the Deluge : the impact of the two World Wars on the historical works of Henri Pirenne and Marc Bloch." In *Nationalizing the past : historians as nation builders in modern Europe*, eds. Stefan Berger and Chris Lorenz. 404–425. New York: Palgrave Macmillan, 2010.

Schöttler, Peter. "Annales." In *Historiographies : concepts et débats. Vol. 1*, eds. Christian Delacroix, François Dosse, Patrick Garcia, and Nicolas Offenstadt. 33–41. Paris: Gallimard, 2010.

Schöttler, Peter. “Marcel Boll, physicien-philosophe et critique d’Émile Meyerson.” *Corpus : revue de philosophie* 58 (2010): 143–157.

Schöttler, Peter. “(in Japanese) The timeliness of Marc Bloch, pt 1.” *Misuzu* 51 (585 2010): 6–21.

Schöttler, Peter. “(in Japanese) The timeliness of Marc Bloch, pt 2.” *Misuzu* 51 (587 2010): 12–29.

Schöttler, Peter. “Alphatier.” In *Eine Naturgeschichte für das 21. Jahrhundert : hommage à, zu Ehren von, in honor of Hans-Jörg Rheinberger*, 210–211. Berlin: Max-Planck-Institut für Wissenschaftsgeschichte, 2011.

Schöttler, Peter. “De Humboldt à Hitler : une courte histoire des universités allemandes.” *Forum* (312 2011): 48–53:
http://www.forum.lu/pdf/artikel/7300_312_Schoettler.pdf

Schöttler, Peter. “Deutsche Historiker und ihre Geschichte [Interview].” *Tageblatt*, 10. 10. 2011: <http://www.tageblatt.lu/kultur/bucher/story/18552077>

Schöttler, Peter. “Karl Ferdinand Werner et l’histoire du temps présent.” *Francia* 38 (2011): 179–189.

Schöttler, Peter. “Nach der Angst : was könnte bleiben vom ‘linguistic turn’ ?” *Internationales Archiv für Sozialgeschichte der deutschen Literatur* 36 (1 2011): 135–151.

Schöttler, Peter. “Dreierlei Kollaboration : Europa-Konzepte und deutsch-französische Verständigung – am Beispiel der Karriere von SS-Brigadeführer Gustav Krukenberg.” *Zeithistorische Forschungen* 9 (3 2012): 365–386:
<http://www.zeithistorische-forschungen.de/16126041-Schoettler-3-2012>

Schöttler, Peter. “Fernand Braudel, prisonnier en Allemagne : face à la longue durée et au temps présent.” In *La captivité de guerre au XXe siècle : des archives, des histoires, des mémoires*, eds. Anne-Marie Pathé and Fabien Théofilakis. 128–140. Paris: Colin, 2012.

Schöttler, Peter. “Glaube, Mystik, Aberglauben : Interview mit Balduin Sulzer.” *Kosmos Österreich* 41 (2012): 22–28: <http://www.kulturforumberlin.at/kosmos-oesterreich/kosmos-41/komet-honoris-causa/>



- 1 Schöttler, Peter, ed. *Lefebvre, Georges: Napoleon*. Reclam-Taschenbuch ; 20251. Stuttgart: Reclam, 2012.

Schöttler, Peter. “Szientismus : zur Geschichte eines schwierigen Begriffs.” *NTM* 20 (4 2012): 245–269.

Schwegman, Jeffrey. “The ‘system’ as a reading technology : pedagogy and philosophical criticism in Condillac’s ‘Traité des systèmes.’” *Journal of the History of Ideas* 71 (3 2010): 387–409.

Schwerin, Alexander von. “Kaninchen (gebraten).” In *Eine Naturgeschichte für das 21. Jahrhundert : hommage à, zu Ehren von, in honor of Hans-Jörg Rheinberger*, 121–122. Berlin: Max-Planck-Institut für Wissenschaftsgeschichte, 2011.

Schwerin, Alexander von. “Humangenetik im Atomzeitalter : von der Mutationsforschung zum genetischen Bevölkerungsregister.” In *Das Heidelberger Institut für Humangenetik : Vorgeschichte und Ausbau (1962–2012) ; Festschrift zum 50jährigen Jubiläum*, eds. Anne Cottebrune and Wolfgang U. Eckart. 82–105. Heidelberg: Ruprecht-Karls-Universität, 2012.

Schwerin, Alexander von. “Mutagene Umweltstoffe : Gunter Röhrborn und eine vermeintlich neue eugenische Bedrohung.” In *Das Heidelberger Institut für Humangenetik : Vorgeschichte und Ausbau (1962–2012) ; Festschrift zum 50jährigen Jubiläum*, eds. Anne Cottebrune and Wolfgang U. Eckart. 106–129. Heidelberg: Ruprecht-Karls-Universität, 2012.

Schwerin, Alexander von. “Österreich im Atomzeitalter : Anschluß an die Ökonomie der Radioisotope.” In *Kernforschung in Österreich : Wandlungen eines interdisziplinären Forschungsfeldes 1900–1978*, eds. Silke Fengler and Carola Sachse. 367–394. Wien [u. a.]: Böhlau, 2012.

- 2 Sepkoski, David. *Rereading the fossil record : the growth of paleobiology as an evolutionary discipline*. Chicago [u. a.]: The University of Chicago Press, 2012.

Serpente, Norberto. “Interactome.” In *Eine Naturgeschichte für das 21. Jahrhundert : hommage à, zu Ehren von, in honor of Hans-Jörg Rheinberger*, 40–42. Berlin: Max-Planck-Institut für Wissenschaftsgeschichte, 2011.

Shea, William R. *see Righini Bonelli and Shea*

- 3 Shi, Yunli, ed. *Hai wai zhen xi Zhongguo ke xue ji shu dian ji ji cheng*. Beijing: Zhongguo ke xue ji shu da xue chu ban she, 2010.
- 4 Shi, Yunli. *Ke xue jian shi*. Beijing: Shou du jing ji mao yi da xue chu ban she, 2010.

Sibum H. Otto *see Aubin, Bigg and Sibum*

Siebert, Martina *see Messner and Siebert*

Sigurdsson, Skúli. "Rivers." In *Eine Naturgeschichte für das 21. Jahrhundert : hommage à, zu Ehren von, in honor of Hans-Jörg Rheinberger*, 46–47. Berlin: Max-Planck-Institut für Wissenschaftsgeschichte, 2011.

Silva da Silva, Circe Mary and Ligia Arantes Sad. "The transformations of knowledge through cultural interactions in Brazil : the case of the Tupinikim and the Guarani." In *The globalization of knowledge in history*, ed. Jürgen Renn. 525–558. Berlin: epubli GmbH, 2012: http://www.edition-open-access.de/studies/1/chapter_26.html

Simões, Ana *see Gavroglu and Simões*

Slaby, Jan and Suparna Choudhury. "Proposal for a critical neuroscience." In *Critical neuroscience : a handbook of the social and cultural contexts of neuroscience*, eds. Suparna Choudhury and Jan Slaby. 29–51. Chichester: Wiley-Blackwell, 2012.

Solhdju, Katrin. "Reisen in den Wahnsinn : ein Pariser Experimentalsystem um 1850." In *Wir sind Experimente: wollen wir es auch sein!*, eds. Michael Gamper, Martina Wernli, and Jörg Zimmer. 178–206. Göttingen: Wallstein, 2010.

Stadler, Max. "Biophysikalisches Doppelleben, 1939–1946. Oder: Räume der Lange-weile : zur (Nicht-)Zäsur des 'Informationsdiskurses.'" *Berichte zur Wissenschaftsgeschichte* 34 (1 2011): 27–63.

Stadler, Max. "Cell." In *Eine Naturgeschichte für das 21. Jahrhundert : hommage à, zu Ehren von, in honor of Hans-Jörg Rheinberger*, 224–226. Berlin: Max-Planck-Institut für Wissenschaftsgeschichte, 2011.

Stadler, Max. "The neurological patient in history : a commentary." In *The neurological patient in history*, eds. L. Stephen Jacyna and Stephen T. Casper. 223–230. Rochester, NY [u. a.]: University of Rochester Press, 2012.

Stadler, Max. "The neuromance of cerebral history." In *Critical neuroscience : a handbook of the social and cultural contexts of neuroscience*, eds. Suparna Choudhury and Jan Slaby. 135–158. Chichester: Wiley-Blackwell, 2012.

Stahnisch, Frank W. *see also Bergua, Schoenherr and Stahnisch*

Stahnisch, Frank W. *see also Werner, Zittel and Stahnisch*

Stahnisch, Frank W. *see also Wolbring, Legg and Stahnisch*

Stahnisch, Frank W. "German-speaking émigré neuroscientists in North America after 1933 : critical reflections on emigration-induced scientific change." *Österreichische Zeitschrift für Geschichtswissenschaften* 21 (3 2010): 36–68.

Stahnisch, Frank W. "The human nervous system – a clavichord? On the use of metaphors in the history of modern neurology." In *Neurology of music*, ed. Frank Clifford Rose. 73–101. London: Imperial College Press, 2010.

Stahnisch, Frank W. "‘Der Rosenthal’sche Versuch’ oder: Über den Ort produktiver Forschung – zur Exkursion des physiologischen Experimentallabors von Isidor Rosenthal (1836–1915) von der Stadt aufs Land." *Sudhoffs Archiv* 94 (1 2010): 1–30.

Stahnisch, Frank W. "The essential tension : on ethical and historical conundrums in the trajectories of deep brain stimulation." In *Implanted minds : the neuroethics of intracerebral stem cell transplantation and deep brain stimulation*, eds. Heiner Fangerau, Jörg M. Fegert, and Thorsten Trapp. 151–181. Bielefeld: Transcript, 2011.

Stahnisch, Frank W. "Experimentalstrategien und Teleologie des Lebendigen in unterschiedlichen Kontexten : physiologische Forschung bei Xavier Bichat (1771–1802) und François Magendie (1783–1855)." *Würzburger medizinhistorische Mitteilungen* 30 (2011): 350–385.

Stahnisch, Frank W. "Flexible Antworten – Offene Fragen : zu den Förderungsstrategien der Rockefellerstiftung für die deutsche Hirnforschung im Nationalsozialismus." *Journal für Neurologie, Neurochirurgie und Psychiatrie* 12 (1 2011): 56–62.

Stahnisch, Frank W. "The emergence of ‘Nervennahrung’ : mind and metabolism in the long eighteenth century." *Studies in History and Philosophy of Biological and Biomedical Sciences* 43 (2 2012): 405–417.

- 1 Stahnisch, Frank W. *Medicine, life and function : experimental strategies and medical modernity at the intersection of pathology and physiology*. Aspekte der Medizinphilosophie ; 11. Bochum [u. a.]: Projektverlag, 2012.

Stahnisch, Frank W. "The Tertium Comparationis of the Elementa Physiologiae – Johann Gottfried von Herder’s conception of ‘tears’ as mediators between the sublime and the actual bodily physiology." In *Blood, sweat and tears : the changing concepts of physiology from antiquity into early modern Europe*, eds. Manfred Horstmanshoff, Helen King, and Claus Zittel. 595–626. Leiden [u. a.]: Brill, 2012.

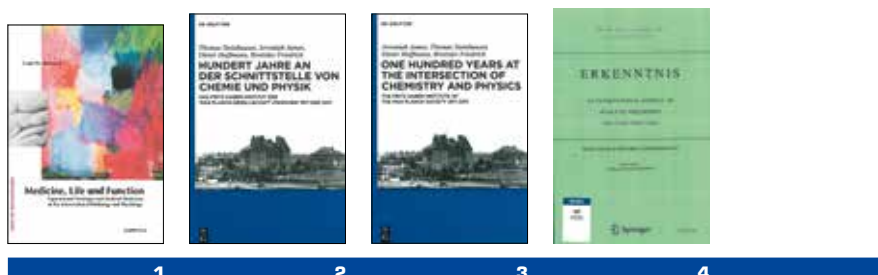

Stahnisch, Frank W. and Thomas Hoffmann. “Kurt Goldstein and the neurology of movement during the interwar years : physiological experimentation, clinical psychology and early rehabilitation.” In *Was bewegt uns? Menschen im Spannungsfeld zwischen Mobilität und Beschleunigung*, eds. Christian Hoffstadt, Franz Peschke, Andreas Schulz-Buchta, and Michael Nagenborg. 283–311. Bochum [u. a.]: Projektverlag, 2010.

Staley, Richard. “Michelson and the observatory : physics and the astronomical community in late nineteenth-century America.” In *The heavens on earth : observatories and astronomy in nineteenth-century science and culture*, eds. David Aubin, Charlotte Bigg, and H. Otto Sibum. 225–252. Durham, N.C. [u. a.]: Duke University Press, 2010.

2 Steinhauser, Thomas, Jeremiah James, Dieter Hoffmann, and Bretislav Friedrich, eds. *Hundert Jahre an der Schnittstelle von Chemie und Physik : das Fritz-Haber-Institut der Max-Planck-Gesellschaft zwischen 1911 und 2011*. Berlin [u. a.]: de Gruyter, 2011.

3 Steinhauser, Thomas, Jeremiah James, Dieter Hoffmann, and Bretislav Friedrich, eds. *One hundred years at the intersection of chemistry and physics : the Fritz Haber Institute of the Max Planck Society 1911–2011*. Berlin [u. a.]: de Gruyter, 2011.

Sturm, Thomas *see also Wunderlich and Sturm*

4 Sturm, Thomas and Uljana Feest, eds. *What (good) is historical epistemology?* Erkenntnis ; 75,3. Special issue. Dordrecht [u. a.]: Springer, 2011.

Suárez Díaz, Edna *see also Barahona and Suárez Díaz*

Suárez Díaz, Edna. “Making room for new faces : evolution, genomics, and the growth of bioinformatics.” *History and Philosophy of the Life Sciences* 32 (1 2010): 65–90.

Sundermeyer, Kurt *see Blum, Renn, Salisbury, Schemmel and Sundermeyer*

Sýkorová, Jitka and Luděk Vacín. “Bibliography of Blahoslav Hruška.” In *U4 du11-ga-ni sá mu-ni-ib-du11 : ancient Near Eastern studies in memory of Blahoslav Hruška*, ed. Luděk Vacín. 1–29. Dresden: ISLET-Verlag, 2011.



Teissier, Pierre. “Solid-state chemistry in France : structures and dynamics of a scientific community since World War II.” *Historical Studies in the Natural Sciences* 40 (2 2010): 225–258.

Thiering, Martin *see also* Renn, Schemmel and Thiering

Thiering, Martin. “Intralingual variation of spatial concepts in an Athapaskan language.” In *Cognitive sociolinguistics : language variation in its structural, conceptual and cultural dimensions ; 34th International LAUD Symposium, March 15–18, 2010, Landau, Pfalz (Germany)*, 92–123. Essen: LAUD, 2010.

Thiering, Martin. “Figure-ground reversals in language.” *Gestalt theory* 33 (3/4 2011): 245–276.

Thiering, Martin. “[Entries] ‘Praktik’, ‘Referenzrahmen’, ‘Spur.’” In *Lexikon der Raumphilosophie*, ed. Stephan Günzel. Darmstadt: Wiss. Buchgesellschaft, 2012.

Thiering, Martin. “Topographical coordinates and spatial language.” In *Cognitive psycholinguistics : bilingualism, cognition and communication ; Proceedings of the 35th International LAUD Symposium, March 26–29, 2012*, 1–58. Landau/Pfalz: LAUD, 2012.

Tholen, Georg Christoph. “Auge, Blick und Bild : zur Intermedialität der Blickregime.” In *Blickregime und Dispositive audiovisueller Medien*, eds. Nadja Elia-Borer, Samuel Sieber, and Georg Christoph Tholen. 19–30. Bielefeld: Transcript, 2011.

Tian, Miao *see* Zhang and Tian

Tillberg, Margareta. “The cold war from a Swedish perspective.” In *A new deal : post-soviet realities meet welfare state models ; in what way will this reflect on the arts?*, ed. Margareta Tillberg. 25–38. Lund: Swedish Art Critics Association Press, 2010.

Tillberg, Margareta. “‘Litteraturen är tankebärande, men inte konsten’ : om synen på konstens epistemologiska värde inom vetenskapen.” In *Det åskådliga och det bottenlösa : tankar om konst och humaniora tillägnade Margaretha Rossholm*

Lagerlöf, eds. Margaretha Rossholm Lagerlöf and Tomas Björk. 247–254. Stockholm: Konstvetenskapliga Institutionen, Stockholms Universitet, 2010.

Tillberg, Margareta. “Made in the USSR : design of electronic / electrical systems in the Soviet Union from Khrushchev’s thaw to Gorbachev’s perestroika.” *Baltic Worlds* 3 (2 2010): 34–40.

Tillberg, Margareta. “Matjusins ‘erweitertes Sehen’ : Klangechos auf der Netzhaut.” In *Ultravision : zum Wissenschaftsverständnis der Avantgarde*, eds. Sabine Flach and Margarete Vöhringer. 35–60. München: Fink, 2010.

- 1 Tillberg, Margareta, ed. *A new deal : post-soviet realities meet welfare state models ; in what way will this reflect on the arts?* Lund: Swedish Art Critics Association Press, 2010.

Tillberg, Margareta. “‘Be a spectator with a large ear’ : ‘Victory over the Sun’ as a public laboratory experiment for Mikhail Matiushin’s theories of colour vision.” In *Victory over the sun : the world’s first futurist opera*, eds. Rosamund Bartlett and Sarah Dadswell. 208–223. Exeter: University of Exeter Press, 2012.

Tillberg, Margareta and John Peter Nilsson. “A new deal : post-soviet realities meet welfare state models ; in what way will this reflect on the arts?” In *A new deal : post-soviet realities meet welfare state models ; in what way will this reflect on the arts?*, ed. Margareta Tillberg. 9–14. Lund: Swedish Art Critics Association Press, 2010.

Tkaczyk, Viktoria *see also Hauschild, Heinrich, Potthast and Tkaczyk*

Tkaczyk, Viktoria *see also Lazardzig and Tkaczyk*

- 2 Tkaczyk, Viktoria. *Himmels-Falten : zur Theatralität des Fliegens in der Frühen Neuzeit*. München: Fink, 2011.

Tkaczyk, Viktoria. “Leonardo da Vinci’s Theater van het Vliegen.” *Deus ex machina* 137 (2011): 78–85.

Tkaczyk, Viktoria. “La parole et l’apprentissage par coeur.” *Théâtre public* 201 (2011): 118–123.

Tkaczyk, Viktoria. “Performativität und Wissen(schaft)sgeschichte.” In *Theorien des Performativen : Sprache – Wissen – Praxis ; eine kritische Bestandsaufnahme*, eds. Klaus W. Hempfer and Jörg Volbers. 115–139. Bielefeld: Transcript, 2011.

Tkaczyk, Viktoria. “Renaissance oder Resonanz : Kunst und Wissenschaft des Fliegens bei Leonardo da Vinci.” *Forum Modernes Theater* 25 (2 2012): 143–158.

Tkaczyk, Viktoria. "Theater und Wortgedächtnis : eine Spurensuche nach der Gegenwart." In *Die Aufführung : Diskurs – Macht – Analyse*, ed. Erika Fischer-Lichte. 275–289. München: Fink, 2012.

Tresch, John. "Experimental ethics and the science of the meditating brain." In *Neurocultures : glimpses into an expanding universe*, eds. Francisco Ortega and Fernando Vidal. 49–68. Frankfurt/M. [u. a.]: Lang, 2011.

Tsouparopoulou, Christina *see also Kantel, Damerow, Köhler and Tsouparopoulou*

Tsouparopoulou, Christina. "The K-9 corps of the third dynasty of Ur : the dog handlers at Drehem and the army." *Zeitschrift für Assyriologie und Vorderasiatische Archäologie* 102 (1 2012): 1–16.

Vacín, Luděk *see also Sykorová and Vacín*

Vacín, Luděk. "Corrigenda to N.A.B.U. 2/2010, no. 32." *Nouvelles assyriologiques brèves et utilitaires (N.A.B.U.)* (3 2010): 77–78.

Vacín, Luděk. "A new Sumerian proverb." *Nouvelles assyriologiques brèves et utilitaires* (2 2010): 39–40.

Vacín, Luděk. "‘Youth known to An among the gods’ : a new look at the ‘coronation hymns’ of king Šulgi." In *Shepherds of the black-headed people : the royal office vis-à-vis godhead in ancient Mesopotamia*, eds. Kateřina Šašková, Lukáš Pecha, and Petr Charvát. 89–109. Plzen: Západočeská univerzita, 2010.

- 1 Vacín, Luděk, ed. *U4 du11-ga-ni sá mu-ni-ib-du11 : ancient Near Eastern studies in memory of Blahoslav Hruška*. Dresden: ISLET-Verlag, 2011.

Vacín, Luděk. "Gudea and Ningišzida : a ruler and his god." In *U4 du11-ga-ni sá mu-ni-ib-du11 : ancient Near Eastern studies in memory of Blahoslav Hruška*, ed. Luděk Vacín. 253–275. Dresden: ISLET-Verlag, 2011.

Vacín, Luděk. "Vzpomínky na Šulgiho : obraz proslulého panovníka v mezopotamském písemnictví po pádu III. dynastie urské." *Acta FF ZČU* (3 2011): 133–144. <http://www.zcu.cz/ff/research/edicni-cinnost/acta/>

Vacín, Luděk. "Dva mýty o mauzoleu Klementa Gottwalda." *Literární noviny* 23 (36 2012): 22–23.

Vackimes, Sophia. "Plague." In *Eine Naturgeschichte für das 21. Jahrhundert : hommage à, zu Ehren von, in honor of Hans-Jörg Rheinberger*, 95–97. Berlin: Max-Planck-Institut für Wissenschaftsgeschichte, 2011.

Valleriani, Matteo. "L'accusa di plagio era impensabile nel Rinascimento." *La Stampa*, 01.09. 2010, 25.



- 2 Valleriani, Matteo. *Galileo engineer*. Boston studies in the philosophy of science ; 269. Dordrecht [u. a.]: Springer, 2010.

Valleriani, Matteo. "The garden of Pratolino : ancient technology breaks through the barriers of modern iconology." In *Ludi naturae : Spiele der Natur in Kunst und Wissenschaft*, eds. Natascha Adamowsky, Hartmut Böhme, and Robert Felfe. 121–141. München: Fink, 2010.

Valleriani, Matteo. "Der Garten von Pratolino." In *Wunderforschung : ein Experiment von Kindern, Wissenschaftlern und Künstlern*, eds. Katja Bödeker and Carmen Hammer. 95–102. Berlin: Nicolai, 2010.

Valleriani, Matteo. "Il ruolo della pneumatica antica durante il Rinascimento : l'esempio dell'organo idraulico nel giardino di Pratolino." In *La civiltà delle acque tra Medioevo e Rinascimento : atti del convegno internazionale, Mantova, 1–4 ottobre 2008. Vol. 2*, eds. Arturo Calzona and Daniela Lamberini. 613–632. Firenze: Olschki, 2010.

Valleriani, Matteo. "The war in Ariosto's Orlando furioso : a snapshot of the passage from medieval to early modern technology." In *War in words : transformations of war from antiquity to Clausewitz*, eds. Marco Formisano and Hartmut Böhme. 375–390. Berlin [u. a.]: de Gruyter, 2010.

Valleriani, Matteo. "L'esperienza e la nascita della balistica all'inizio dell'età moderna." In *La scienza delle armi : Luigi Ferdinando Marsili 1658–1730*, 93–107. Bologna: Pendragon, 2012.

Valleriani, Matteo. "Galileo's abandoned project on acoustic instruments at the Medici Court." *History of Science* 50 (1 2012): 1–31.

Valleriani, Matteo. "The knowledge Agora : the role of the officials." In *Cultures of knowledge : technology in Chinese history*, ed. Dagmar Schäfer. 233–246. Leiden [u. a.]: Brill, 2012.

Vicedo Castello, Marga. "The social nature of the mother's tie to the child : John Bowlby's theory of attachment in post-war America." *The British Journal for the History of Science* 44 (3 2011): 401–426.



Vidal, Fernando *see also Ortega and Vidal*

Vidal, Fernando. “Histoire de la psychologie et ‘Geschichte der Menschheit’ : l’oeuvre de Friedrich August Carus (1770–1809).” In *Göttingen vers 1800 : l’Europe des sciences de l’homme*, eds. Hans Erich Bödeker, Philippe Büttgen, and Michel Espagne. 221–246. Paris: Editions du Cerf, 2010.

Vidal, Fernando. “Fiction film and the cerebral subject.” In *Neurocultures : glimpses into an expanding universe*, eds. Francisco Ortega and Fernando Vidal. 329–344. Frankfurt/M. [u. a.]: Lang, 2011.

Vidal, Fernando. “Human persons and human brains : a historical perspective within the Christian tradition.” In *Rethinking human nature : a multidisciplinary approach*, ed. Malcolm Jeeves. 30–57. Grand Rapids, Mich.: Eerdmans, 2011.

Vidal, Fernando. “Memory, movies, and the brain.” In *The memory process : neuroscientific and humanistic perspectives*, eds. Suzanne Nalbantian, Paul M. Matthews, and James L. McClelland. 395–415. Cambridge, Mass.: MIT Press, 2011.

- 1 Vidal, Fernando. *The sciences of the soul : the early modern origins of psychology*. Translated by Saskia Brown. Chicago [u. a.]: The Chicago University Press, 2011.

Vidal, Fernando. “Von unserem eigenen Gehirn überlebt.” In *Images of the Mind : Bildwelten des Geistes aus Kunst und Wissenschaft*, eds. Colleen M. Schmitz and Ladislav Kesner. 41–48. Göttingen: Wallstein, 2011.

Vidal, Fernando and Rosália Duarte. “Identidade e cérebro : o que o cinema tem a dizer.” In *Filosofia, cinema e educação*, eds. Jorge Mirande de Almeida and Itamar Pereira de Aguiar. 133–156. Vitória da Conquista: Edições UESB, 2010.

Vidal, Fernando and Francisco Ortega. “Approaching the neurocultural spectrum : an introduction.” In *Neurocultures : glimpses into an expanding universe*, eds. Francisco Ortega and Fernando Vidal. 7–27. Frankfurt/M. [u. a.]: Lang, 2011.

Vidal, Fernando and Francisco Ortega. “Are there neural correlates of depression?” In *Critical neuroscience : a handbook of the social and cultural contexts of neuroscience*, eds. Suparna Choudhury and Jan Slaby. 345–366. Chichester: Wiley-Blackwell, 2012.

Vimieiro Gomes, Ana Carolina. “A emergência da biotipologia no Brasil : medir e classificar a morfologia, a fisiologia e o temperamento do brasileiro na década de 1930.” *Boletim do Museu Paraense Emílio Goeldi : ciências humanas* 7 (3 2012): 705–719.

- 2 Vlahakis, George N., and Kostas Tabakis, eds. *The keys to knowledge : 19th century textbooks & books on the popularization of science ; exhibition 15 June–16 July 2011 = Κλειδιά της γνώσης : Διδακτικά εγχειρίδια και βιβλία επιστημονικής εκλαΐκευσης ; Έκθεση*. Athen: University of Athens, 2011:
<http://www.hpdst.gr/system/files/1106-keys-of-knowledge-catalogue.pdf>

Vogt, Annette *see also* Jarausch, Middell and Vogt

Vogt, Annette. “Barrieren und Karrieren – am Beispiel der Wissenschaftlerinnen in Instituten der Kaiser-Wilhelm-Gesellschaft.” In *Frauen in der Wissenschaft – Frauen an der TU Dresden : Tagung aus Anlass der Zulassung von Frauen zum Studium in Dresden vor 100 Jahren*, eds. Hildegard Küllchen, Sonja Koch, Brigitte Schober, and Susanne Schötz. 161–179. Leipzig: Leipziger Universitätsverlag, 2010.

Vogt, Annette. “Die Ehrenpromotionen der Humboldt-Universität von 1947 bis 1960/68.” In *Die Humboldt-Universität Unter den Linden 1945 bis 1990 : Zeitzeugen – Einblicke – Analysen*, eds. Wolfgang Girnus and Klaus Meier. 107–127. Leipzig: Leipziger Universitätsverlag, 2010.

Vogt, Annette. “In memoriam : Boris Abramovic Rosenfeld (1917–2008).” *Historia Mathematica* 37 (1 2010): 8–10.

Vogt, Annette. “The role of tables in the history of different styles of thinking in statistics.” In *Styles of thinking in science and technology : proceedings of the 3rd International Conference of the European Society for the History of Science ; Vienna, September 10–12, 2008 (CD-ROM)*, eds. Hermann Hunger, Felicitas Seebacher, and Gerhard Holzer. 376–383. Wien: Verlag der Österreichischen Akademie der Wissenschaften, 2010.

Vogt, Annette. “[Entries] ‘Kobel’, ‘Kornfeld’, ‘Kremer’, ‘Sponer’, ‘Shtern’, ‘Vogt’, ‘Woker.’” In *European women in chemistry*, eds. Jan Apotheker and Livia Simon Sarkadi. Weinheim: Wiley-VCH, 2011.

Vogt, Annette. “Vom Wiederaufbau der Berliner Universität bis zum Universitäts-Jubiläum 1960.” In *Geschichte der Universität unter den Linden. Vol. 3: Sozialistisches Experiment und Erneuerung in der Demokratie – die Humboldt-Universität zu Berlin 1945–2010*, eds. Konrad H. Jarausch, Matthias Middell, and Annette Vogt. 125–250. Berlin: Akademie Verlag, 2012.

Vogt, Annette. “Wissenschaftlerinnen im Exil – Abbruch, Neubeginn oder Erfolg der Karriere.” In *Alma Maters Töchter im Exil : zur Vertreibung von Wissenschaftler-*

innen und Akademikerinnen in der NS-Zeit, eds. Inge Hansen-Schaberg and Hiltrud Häntzschel. 19–45. München: Edition Text + Kritik, 2011.

Volmar, Axel. "Listening to the body electric : electrophysiology and the telephone in the late 19th century." *The virtual laboratory : essays and resources on the experimentalization of life* (2010): 1–13: <http://vlp.mpiwg-berlin.mpg.de/essays/data/art76>

Wahsner, Renate *see also Borzeszkowski and Wahsner*

Wahsner, Renate. "[Entries] 'Atomismus', 'Bewegung', 'Messung.'" In *Enzyklopädie Philosophie. Vol. 1–2*, eds. Hans Jörg Sandkühler, Volker Schürmann, and Pirmin Stekeler-Weithofer. 2. Auflage. Hamburg: Meiner, 2010.

Wahsner, Renate. "Erfordert die moderne Naturwissenschaft eine neue Philosophie des Geistes?" In *Bewußtsein zwischen Natur und Geist*, eds. Wolfgang Neuser and Wolfgang Lenski. 41–53. Würzburg: Neumann & Königshausen, 2010.

Wahsner, Renate. "Kann die Hegelsche Naturphilosophie kritisch aufgehoben werden?" In *Hegels Naturphilosophie in der Dritten Moderne : Bestimmungen, Probleme und Perspektiven*, eds. Olaf Breidbach and Wolfgang Neuser. 49–57. Berlin: Verlag für Wissenschaft und Bildung, 2010.

Wahsner, Renate. "Noch einmal zu den Bedingungen einer materialistischen Spekulation : Bemerkungen zu den Beiträgen von A. Hüllinghorst und Th. Metscher in Z. 81." *Zeitschrift marxistische Erneuerung : Z 21* (82 2010): 122–133.

Wahsner, Renate. "Hegels Logik und die Struktur des naturwissenschaftlichen Denkens in der Moderne." In *Hegel-Jahrbuch 2010/11 : Geist? 2. Teil*, eds. Andreas Arndt, Paul Cruysberghs, and Andrzej Przylebski. 148–153. Berlin: Akademie Verlag, 2011.

Wahsner, Renate. "Kants Begründung der Ethik – nach Cohen und deren Kritik." In *Ethik als prima philosophia?*, ed. Hans-Dieter Klein. 151–170. Würzburg: Königshausen & Neumann, 2011.

- 1 Wailoo, Keith, Alondra Nelson, and Catherine Lee, eds. *Genetics and the unsettled past : the collision of DNA, race, and history*. New Brunswick, N. J. [u. a.]: Rutgers University Press, 2012.

Watson, Cecelia. "Points of contention : rethinking the past, present, and future of punctuation." *Critical Inquiry* 38 (3 2012): 649–672.

Wazeck, Milena. "The relativity deniers." *New Scientist* (13 November 2010): 48–51.

Wegener, Mai. "Laienanalyse, wilde Analyse und die Lacanianer : Psychoanalytiker als unmögliche Experten – Experten des Unmöglichen." In *Dilettantismus als Beruf*, eds. Safia Azzouni and Uwe Wirth. 143–162. Berlin: Kulturverlag Kadmos, 2010.

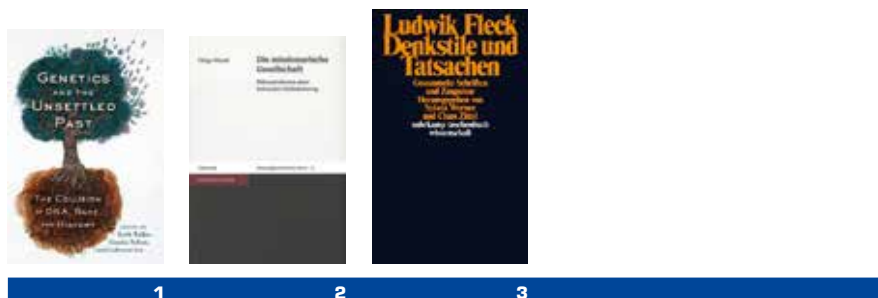

Wegener, Mai. "Nabel." In *Eine Naturgeschichte für das 21. Jahrhundert : hommage à, zu Ehren von, in honor of Hans-Jörg Rheinberger*, 42–43. Berlin: Max-Planck-Institut für Wissenschaftsgeschichte, 2011.

Wendt, Helge see also *Wilkens, Ramponi and Wendt*

Wendt, Helge. "Mission transnational, trans-kolonial, global." *Schweizerische Zeitschrift für Religions- und Kulturgeschichte* 105 (2011): 95–116.

- 2** Wendt, Helge. *Die missionarische Gesellschaft : Mikrostrukturen einer kolonialen Globalisierung*. Missionsgeschichtliches Archiv ; 17. Stuttgart: Steiner, 2011.

Wendt, Helge. "Migration in Missionen : drei Fallbeispiele räumlicher und sozialer Mobilität im 19. Jahrhundert." In *Migration und Reisen : Mobilität in der Neuzeit*, eds. Elena Taddei, Michael Müller, and Robert Rebitsch. 283–294. Innsbruck [u. a.]: Studien Verlag, 2012.

Wendt, Helge. "Moralisches Wissen : der Umgang mit der Frage der Ehe in unterschiedlichen Missionskontexten im 19. Jahrhundert." In *Missionsgeschichte als Geschichte der Globalisierung von Wissen : transkulturelle Wissensaneignung und -vermittlung durch christliche Missionare in Afrika und Asien im 17., 18. und 19. Jahrhundert*, eds. Ulrich van der Heyden and Andreas Feldtkeller. 429–440. Stuttgart: Steiner, 2012.

Wendt, Helge and Jürgen Renn. "Knowledge and science in current discussions of globalization." In *The globalization of knowledge in history*, ed. Jürgen Renn. 45–72. Berlin: epubli GmbH, 2012: http://www.edition-open-access.de/studies/1/chapter_5.html

- 3** Werner, Sylwia, Claus Zittel, and Frank W. Stahnisch, eds. *Ludwik Fleck : Denkstile und Tatsachen ; gesammelte Schriften und Zeugnisse*. Suhrkamp Taschenbuch Wissenschaft ; 1953. Berlin: Suhrkamp, 2011.

Werrett, Simon. "The astronomical capital of the world : Pulkovo observatory in the Russia of Tsar Nicholas I." In *The heavens on earth : observatories and astronomy in nineteenth-century science and culture*, eds. David Aubin, Charlotte Bigg, and H. Otto Sibum. 33–57. Durham, N.C. [u. a.]: Duke University Press, 2010.



Wessely, Christina. “Das Geschäft mit der Welt aus Eis : kosmologischer Dilettantismus und die professionelle Verführung der Massen um 1900.” In *Dilettantismus als Beruf*, eds. Safia Azzouni and Uwe Wirth. 95–112. Berlin: Kulturverlag Kadmos, 2010.

Wessely, Christina. “Wasser.” In *Eine Naturgeschichte für das 21. Jahrhundert : hommage à, zu Ehren von, in honor of Hans-Jörg Rheinberger*, 234–236. Berlin: Max-Planck-Institut für Wissenschaftsgeschichte, 2011.

Westermann, Lidia *see Hoffmann and Westermann*

Whitmer, Kelly J. “The model that never moved : the case of a virtual memory theater and its christian philosophical argument, 1700–1732.” *Science in Context* 23 (3 2010): 289–327.

Whitmer, Kelly J. “Lilium.” In *Eine Naturgeschichte für das 21. Jahrhundert : hommage à, zu Ehren von, in honor of Hans-Jörg Rheinberger*, 51–52. Berlin: Max-Planck-Institut für Wissenschaftsgeschichte, 2011.

Widmer, Alexandra. “Native medical practitioners, temporality, and nascent biomedical citizenship in the new Hebrides.” *Political and Legal Anthropology Review* 33 (Suppl. 1 2010): 57–80.

Widmer, Alexandra. “Making mothers : birth and the changing relationships of mothering in Pango Village, Vanuatu.” In *An anthropology of mothering*, eds. Michelle Walks and Naomi MacPherson. 102–114. Bradford: Demeter Press, 2011.

Widmer, Alexandra. “From research encounters to metropolitan debates : the making and meaning of the Melanesian ‘race’ during demographic decline.” *Paideuma* 58 (2012): 69–93.

Wilder, Kelley. “Visualizing radiation : the photographs of Henri Becquerel.” In *Histories of scientific observation*, eds. Lorraine Daston and Elizabeth Lunbeck. 349–368. Chicago: The University of Chicago Press, 2011.

- 1 Wilkens, Anna E., Patrick Ramponi, and Helge Wendt, eds. *Inseln und Archipele : kulturelle Figuren des Insularen zwischen Isolation und Entgrenzung*. Kultur- und Medientheorie. Bielefeld: Transcript, 2011.

- 2 Windgätter, Christof, ed. *Wissen im Druck : zur Epistemologie der modernen Buchgestaltung*. Buchwissenschaftliche Beiträge ; 80. Wiesbaden: Harrassowitz, 2010.

Windgätter, Christof. "Vom 'Blattwerk der Signifikanz' oder: Auf dem Weg zu einer Epistemologie der Buchgestaltung." In *Wissen im Druck : zur Epistemologie der modernen Buchgestaltung*, ed. Christof Windgätter. 6–50. Wiesbaden: Harrassowitz, 2010.

Winter, Christine. "Changing frames : identity and citizenship of New Guineans of German heritage during the inter-war years." *Journal of Pacific History* 47 (3 2012): 347–367.

Wittmann, Barbara *see also* Azzouni, Brandt, Gausemeier, Kursell, Schmidgen and Wittmann

Wittmann, Barbara. "Lost in attention : erneut zu Edouard Manets Porträtkunst." In *Ähnlichkeit und Entstellung : Entgrenzungstendenzen des Porträts*, eds. Werner Busch, Oliver Jehle, Bernhard Maaz, and Sabine Slanina. 107–116. München: Deutscher Kunstverlag, 2010.

Wittmann, Barbara. "Das Steckenpferd als Lebenswerk : Ironie und Utopie der Dilettanten in der Kunst der Moderne." In *Dilettantismus als Beruf*, eds. Safia Azzouni and Uwe Wirth. 181–200. Berlin: Kulturverlag Kadmos, 2010.

Wittmann, Barbara. "Johnny-Head-in-the-Air in America : Aby Warburg's experiment with children's drawings." In *New Perspectives in iconology : visual studies and anthropology*, eds. Barbara Baert, Ann-Sophie Lehmann, and Jenke Van den Akkerveken. 120–142. Brussels: Academic & Scientific Publ., 2011.

Wittmann, Barbara. "Prachtleierschwanz." In *Eine Naturgeschichte für das 21. Jahrhundert : hommage à, zu Ehren von, in honor of Hans-Jörg Rheinberger*, 113–116. Berlin: Max-Planck-Institut für Wissenschaftsgeschichte, 2011.

Wittmann, Barbara. "Winnicotts Arabesken : vom Witz einer psychotherapeutischen Praxis." *Luzifer-Amor* 24 (47 2011): 110–116.

Wittmann, Barbara. "Papierprojekte : die Zeichnung als Instrument des Entwurfs." *Zeitschrift für Medien- und Kulturforschung* (1 2012): 135–150.

Wolbring, Gregor, David Legg, and Frank W. Stahnisch. "Meaning of inclusion throughout the history of the paralympic games and movement." *The International Journal of Sport and Society* 1 (3 2010): 81–94.

Wolf, Herta. "Es werden Sammlungen jeder Art entstehen' : Zeichnen und Aufzeichnen als Konzeptualisierungen der fotografischen Medialität." *Zeitschrift für Medienwissenschaft* 3 (2 2010): 27–41.

Wolters, Gereon. "Mach and Einstein, or, clearing troubled waters in the history of science." In *Einstein and the changing worldviews of physics*, eds. Christoph Lehner, Jürgen Renn, and Matthias Schemmel. 39–57. Boston [u. a.]: Birkhäuser, 2012.

- 1 Wulz, Monika. *Erkenntnisagenten : Gaston Bachelard und die Reorganisation des Wissens*. Kaleidogramme ; 61. Berlin: Kulturverlag Kadmos, 2010.

Wulz, Monika. "Franz and Gwendolin." In *Eine Naturgeschichte für das 21. Jahrhundert : hommage à, zu Ehren von, in honor of Hans-Jörg Rheinberger*, 63–64. Berlin: Max-Planck-Institut für Wissenschaftsgeschichte, 2011.

Wunderlich, Falk. "Johann Georg Sulzers Widerlegung des Materialismus und die Materietheorien der Zeit." In *Johann Georg Sulzer : Aufklärung zwischen Christian Wolff und David Hume*, eds. Frank Grunert and Gideon Stiening. 37–55. Berlin: Akademie Verlag, 2011.

Wunderlich, Falk. "Empirismus und Materialismus an der Göttinger Georgia Augusta – Radikalaufklärung im Hörsaal?" *Aufklärung* (2012): 65–90.

Wunderlich, Falk. "Philosophiegeschichte, Ideengeschichte und das Verhältnis von Philosophie und Wissenschaften im 18. Jahrhundert." In *Klopffechtereien – Missverständnisse – Widersprüche? : methodische und methodologische Perspektiven auf die Kant-Forster-Kontroverse*, eds. Rainer Godel and Gideon Stiening. 211–223. München: Fink, 2012.

Wunderlich, Falk. "[Entry] 'Johann Nicolaus Tetens'" In *The Continuum companion to Kant*, eds. Gary Banham, Nigel Hems, and Dennis Schulting. 145–147. London [u. a.]: Continuum Press, 2012.

Wunderlich, Falk and Thomas Sturm. "Kant and the scientific study of consciousness." *History of the Human Sciences* 23 (3 2010): 48–71.

- 2 Wüthrich, Adrian. *The genesis of Feynman diagrams*. Archimedes ; 26. Dordrecht [u. a.]: Springer, 2010.

Xu, Xiaodong 徐晓东. "Qing dai de zhai jie pai." *Shou cang jia = Collectors – 收藏家* (1 2010): 55–58.

Xu, Xiaodong 徐晓东. "Wen yu wu : yu cong xing zhi ren shi de liu bian" In *Yu hun guo po : Zhongguo gu dai yu qi yu chuan tong wen hua xue shu tao lun hui wen ji*, eds. Jing Yang and Jiang Weidong. 348–360. Zhejiang: Zhejiang chu ban she, 2010.

Zacharias, Sebastian. "Über analytische und synthetische Aussagen in wissenschaftlichen Theorien : eine Antwort auf W. V. O. Quine im Anschluß an Moritz Schlick." In *Moritz Schlick : Ursprünge und Entwicklungen seines Denkens*, eds. Fynn Ole Engler and Mathias Iven. 387–405. Berlin: Parerga, 2010.



Zemplén, Gábor Á. *see also* Kutrovázt, Láng and Zemplén

Zemplén, Gábor Á. “Kognitív munkamegosztás és a tudás termelése.” In *Szubjektív tudás – objektív tudomány*, eds. Zoltán Csörgö and Levente Szabados. 182–193. Budapest: L’Harmattan, 2010.

Zemplén, Gábor Á. “Putting sociology first – reconsidering the role of the social in ‘Nature of Science’ education.” *Science & Education* 18 (5 2010): 525–559.

Zemplén, Gábor Á. “Távol-Keleti orvoslás és a tudomány-tanulmányok poszthumanista fordulata.” In *Határmunkálatok a tudományban*, eds. Gábor Kutrovázt, Benedek Láng, and Gábor Á. Zemplén. 82–100. Budapest: L’Harmattan, 2010.

Zemplén, Gábor Á. “A tudománytörténet(ek) Darwinja(i) – egy mitologizált természetbúvár recepciótörténetéhez.” *Magyar Pszichológia Szemle* 65 (1 2010): 25–36.

Zemplén, Gábor Á. “Early 20th century conventionalism in Hungary : a case for Győző Zemplén’ reappréciation.” In *Der Wiener Kreis in Ungarn = The Vienna circle in Hungary*, eds. András Máté, Miklós Rédei, and Friedrich Stadler. 45–64. Wien: Springer, 2011.

Zemplén, Gábor Á. “Prism.” In *Eine Naturgeschichte für das 21. Jahrhundert : hommage à, zu Ehren von, in honor of Hans-Jörg Rheinberger*, 174–176. Berlin: Max-Planck-Institut für Wissenschaftsgeschichte, 2011.

Zemplén, Gábor Á. and Tamás Demeter. “Being charitable to scientific controversies : lessons from the debate on the demonstrativity of experimentum crucis.” *Monist* 93 (4 2010): 640–656.

Zhang, Baichun and Miao Tian. “Archimedian mechanical knowledge in 17th century China.” In *The genius of Archimedes : 23 centuries of influence on mathematics, science and engineering*, eds. Stephanos A. Paipetis and Marco Ceccarelli. 189–205. Dordrecht [u.a.]: Springer, 2010.

Ziemer, Hansjakob. “Symphonischer Optimismus’ im Konzertsaal : zur Kulturgeschichte des Hörens um 1900.” In *Musik – Bürger – Stadt : Konzertleben und*

musikalisches Hören im historischen Wandel, eds. Christian Thorau, Andreas Odenkirchen, and Peter Ackermann. 279–299. Regensburg: ConBrio, 2011.

Ziemer, Hansjakob. “Hörerlebnisse als soziale Utopie im Fin de Siècle : Mahlers Achte Symphonie im Kontext.” *Jahrbuch des Simon-Dubnow-Instituts = Simon Dubnow Institute Yearbook* 11 (2012): 197–217.

Ziemer, Hansjakob. “Modernizing musical spaces : music halls and utopian communities in Frankfurt am Main, 1900–1930.” In *Making a new world : architecture and communities in Interwar Europe*, eds. Rajesh Heynickx and Tom Avermaete. 155–165. 13th ed. Leuven: Leuven University Press, 2012.

Zik, Yaakov and Giora Hon. “The eccentricity of the Sun : Kepler’s novel method of calculation.” *Journal for the History of Astronomy* 43 (2012): 181–189.

Zik, Yaakov and Giora Hon. “Magnification : how to turn a spyglass into an astronomical telescope.” *Archive for History of Exact Sciences* 66 (4 2012): 439–464.

Zorzanelli, Rafaela *see Ortega and Zorzanelli*

Preprints 2010, 2011, 2012

No. 391 Horst-Heino v. Borzeszkowski & Renate Wahsner Die Fassung der Welt unter der Form des Objekts und der philosophische Begriff der Objektivität

No. 392 Ana Barahona, Edna Suarez-Díaz, and Hans-Jörg Rheinberger (eds.) Hereditary Hourglass. Genetics and Epigenetics, 1868–2000

No. 393 Luis Campos and Alexander von Schwerin (eds.) Making Mutations: Objects, Practices, Contexts

No. 394 Volkmar Schüller Some Remarks on Prop. VIII Probl. II of Newton’s Opticks Book I Part I

No. 395 Tamás Demeter Hume’s Experimental Method

No. 396 Fynn Ole Engler, Björn Henning und Karsten Böger Transformationen der wissenschaftlichen Philosophie und ihre integrative Kraft — Wolfgang Köhler, Otto Neurath und Moritz Schlick

No. 397 Frank W. Stahnisch «Der Rosenthal’sche Versuch» oder: Über den Ort produktiver Forschung — Zur Exkursion des physiologischen Experimentallabors von Isidor Rosenthal (1836–1915) von der Stadt aufs Land

No. 398 Angela Matyssek Überleben und Restaurierung. Barnett Newmans *Who’s afraid of Red, Yellow, and Blue III* und *Cathedra*

No. 399 Susanne Lehmann-Brauns, Christian Sichau, Helmuth Trischler (eds.) The Exhibition as Product and Generator of Scholarship

No. 400 Fynn Ole Engler und Jürgen Renn Wissenschaftliche Philosophie, moderne Wissenschaft und Historische Epistemologie (in preparation)

- No. 401** *M. J. Geller* Look to the Stars: Babylonian medicine, magic, astrology and *melothesia*
- No. 402** *Matthias Schemmel* Medieval Representations of Change and Their Early Modern Application (TOPOI — Towards a Historical Epistemology of Space)
- No. 403** *Frank W. Stahnisch* German-Speaking Émigré Neuroscientists in North America after 1933: Critical Reflections on Emigration-Induced Scientific Change
- No. 404** *Francesca Bordogna* Asceticism and Truth: The Case of ‘Magic Pragmatism’
- No. 405** *Christoph Hoffmann and Alexandre Métraux (eds.)* Working with Instruments — Three Papers of Ernst Mach and Ludwig Mach (Translated by Daniel Bowles)
- No. 406** *Karin Krauthausen* Paul Valéry and Geometry: Instrument, Writing Model, Practice
- No. 407** *Wolfgang Lefèvre* Picturing the World of Mining in the Renaissance. The Schwazer Bergbuch (1556)
- No. 408** *Tobias Breidenmoser, Fynn Ole Engler, Günther Jirikowski, Michael Pohl and Dieter G. Weiss* Transformation of Scientific Knowledge in Biology: Changes in our Understanding of the Living Cell through Microscopic Imaging
- No. 409** *Werner Kogge* Schrift und das Rätsel des Lebendigen. Die Entstehung des Begriffssystems der Molekularbiologie zwischen 1880 und 1950
- No. 410** *Florentina Badalanova Geller 2* (Slavonic Apocalypse of) Enoch: Text and Context
- No. 411** *Henning Schmidgen & Urs Schoepflin (eds.)* Hans-Jörg Rheinberger : a Bibliography
- No. 412** *Renate Wahsner & Horst-Heino v. Borzeszkowski* Erkenntnis statt Erbauung: Hegel und das naturwissenschaftliche Denken der Moderne
- No. 413** *Mirjam Brusius* From photographic science to scientific photography: Photographic experiments at the British Museum around 1850
- No. 414** *Viktor J. Frenkel* Professor Friedrich Houtermans — Arbeit, Leben, Schicksal. Biographie eines Physikers des zwanzigsten Jahrhunderts. Herausgegeben und ergänzt von Dieter Hoffmann, unter Mitwirkung von Mary Beer
- No. 415** *Ilana Löwy (ed.)* Microscope Slides — Reassessing a Neglected Historical Ressource
- No. 416** *André L. Blum, John Michael Krois und Hans-Jörg Rheinberger (Hrsg.)* Verkörperungen
- No. 417** *Pietro Daniel Omodeo* Sixteenth Century Professors of Mathematics at the German University of Helmstedt. A Case Study on Renaissance Scholarly Work and Networks
- No. 418** *Peter Schöttler & Hans-Jörg Rheinberger (éds.)* Marc Bloch et les crises du savoir
- No. 419** *Albert Presas i Puig (ed.)* A Comparative Study of European Nuclear Energy Programs
- No. 420** *Mathias Grote & Max Stadler (eds.)* Membranes Surfaces Boundaries. Interstices in the History of Science, Technology and Culture
- No. 421** *Frank W. Stahnisch* The emergence of *Nervennahrung*: Nerves, mind and metabolism in the long eighteenth century

- No. 422** *Pietro Daniel Omodeo, Irina Tupikova* Aristotle and Ptolemy on Geocentrism: Diverging Argumentative Strategies and Epistemologies (TOPOI — Towards a Historical Epistemology of Space)
- No. 423** *Han F. Vermeulen* Linguistik und Völkerkunde — der Beitrag der historisch-vergleichenden Linguistik von G. W. Leibniz zur Entstehung der Völkerkunde im 18. Jahrhundert [Leicht erweiterte Fassung des Working Papers No. 133 aus dem MPI for Social Anthropology]
- No. 424** *Alfred Gierer* Mit Schiller gegen den “Egoismus der Vernunft”. Zeitübergreifende Gedanken zur Natur des Menschen
- No. 425** *Annette Vogt* Die Berliner Humboldt-Universität von 1945/1946 bis 1960/1961
- No. 426** *Klaus Geus, Martin Thiering (eds.)* Common Sense Geography and Mental Modelling
- No. 427** *Renate Wahsner* Kann eine moderne Naturphilosophie auf Hegelsche Prinzipien gegründet werden? Spekulatives und naturwissenschaftliches Denken
- No. 428** *Stefano Bordon* Widening the Scope of Analytical Mechanics Duhem’s third pathway to Thermodynamics
- No. 429** *Pietro Daniel Omodeo* Copernicus in the Cultural Debates of the Renaissance: Reception, Legacy, Transformation [Part I & II]
- No. 430** *Mark Geller & Klaus Geus (eds.)* Productive Errors: Scientific Concepts in Antiquity (TOPOI — Dahlem Seminar for the History of Ancient Sciences)
- No. 431** *Klaus Gottstein* The Amaldi Conferences. Their Past and Their Potential Future
- No. 432** *Mikuláš Teich* The Scientific Revolution Revisited
- No. 433** *Lorraine Daston & Jürgen Renn (Hrsg.)* Festkolloquium für Hans-Jörg Rheinberger. Beiträge zum Symposium am 24. 1. 2011 im Max-Planck-Institut für Wissenschaftsgeschichte
- No. 434** *Conference* Epistemology and History. From Bachelard and Canguilhem to Today’s History of Science
- No. 435** *Jens Høyrup* Sanskrit-Prakrit interaction in elementary mathematics as reflected in Arabic and Italian formulations of the rule of three — and something more on the rule elsewhere
- No. 436** *Jens Høyrup* A hypothetical history of Old Babylonian mathematics: places, passages, stages, development

Index

A

Abbott, Andrew 88
Abdounur, Oscar Joao 229
Abel, Günter 218
Acerbi, Fabio 154
Adam, Thomas 278
Agnew, Vanessa 99, 229
Alder, Ken 85
Allen, Keith R. 221
Alter, Stephen G. 138
Alt, Peter-André 63
Amad, Paula Tatla 229
Anderson, Warwick Hugh 140, 145, 229
Andersson, Daniel 113, 229, 279
Andretta, Elisa 113, 229, 279
Andrews, Noam 113, 229
Anthony, Scott 87
Arabatzis, Theodore 114, 229
Arana, Andrew 154
Arnaud, Sabine 6, 17, 163, 164, 165, 166, 170, 226, 230, 278
Aronova, Elena 15, 67, 71, 74, 205, 230
Arponen, Vesa 113, 230, 279
Ash, Mitchell 278
Aufrecht, Monica 113, 230, 279
Axworthy, Angela 156, 230
Azzouni, Safia 15, 114, 198, 230, 279

B

Baadj, Nadja Sera 190, 230
Bacciagaluppi, Guido 230
Bacht, Nikolaus 15, 230
Badino, Massimiliano 34, 37, 38, 39, 230
Bado, Jean-Paul 141
Baker, Tawrin 184, 230
Balibar, Françoise 200
Bangham, Jenny 135, 136, 230
Baracca, Angelo 50, 231
Barahona, Ana 201, 380
Bargheer, Stefan 69, 87, 89, 138, 231, 279

Bassiri, Nima 106
Basso, Elisabetta 114, 231
Bauche, Manuela 150, 231
Bauer, Susanne 17, 72, 132, 133, 136, 139, 231, 272, 273, 277, 279, 284
Becchi, Antonio 15, 33, 34, 231
Beckman, Jenny 114, 231
Beck, Naomi 113, 231
Beer, Mary 381
Belhoste, Bruno 231
Bellis, Delphine 156, 157, 231, 280
Bendix, Daniel 141
Benson, Etienne 15, 67, 69, 73, 74, 139, 204, 205, 222, 227, 231, 273, 274, 280
Beretta, Marco 192, 195
Bergmann, Sven 150, 231, 279, 280
Bernardoni, Andrea 195
Berson, Joshua 69, 75, 231, 280
Bertoloni Meli, Domenico 72, 232
Bertram, Sabine 215, 285
Bertucci, Paola 190, 232
Besse, Jean-Marc 80, 232
Bethke, Berit 150, 232
Beurton, Peter 15, 232
Bevilacqua, Fabio 14
Beyer, Marcel 197
Biagioli, Francesca 154
Biank, Johanna 18, 28, 232
Biggam, Carole 175, 195
Bigg, Charlotte 80, 232
Bittel, Carla 96
Blacker, Sarah 140, 150, 232
Blaschke, Estelle 68, 113, 232, 284
Blomme, Henny 157, 232
Blondé, Bruno 195
Blum, Alexander 15, 18, 34, 39, 40, 41, 42, 54, 62, 63, 232
Blum, André L. 381
Blum, Gerd 87
Böger, Karsten 380
Bol, Marjolijn 178, 181, 194, 232
Boltz, William G. 24, 233
Bonolis, Luisa 18
Borchers, Stefan 114, 233
Borck, Cornelius 200
Bordogna, Francesca 94, 233, 381
Bordoni, Stefano 38, 233, 382
Borg, Alexander 195
Bork, Camilla 110
Borkopp-Restle, Birgitt 195
Borrelli, Arianna 233
Borzeszkowski, Horst-Heino v. 380, 381
Bosch, Mineke 96, 99, 233
Bosetti, Alessandro 170
Boucher, Marie-Pier 114, 233
Bouk, Dan 72, 76, 113, 233
Boyce-Jacino, Katherine Sara 113, 233
Boysen, Sigrid 63
Brafman, David 195
Brandenberger, Katharina 114, 233
Brandt, Christina 15, 114, 196, 197, 198, 201, 233, 280
Brauckmann, Urte 215
Braunstein, Jean-François 169, 199
Bray, Francesca 14, 233
Bréard, Andrea 80, 234
Bredenkamp, Horst 222
Breidenmoser, Tobias 381
Brentjes, Sonja 15, 48, 49, 234
Brilmyer, S. Pearl 113, 234
Brody, Martin 86
Bromberg, Joan 40
Bronfman, Alejandra 72
Brusius, Mirjam 76, 113, 234, 272, 381
Buchwald, Jed Zachary 38, 234
Bucklow, Spike 194, 195
Bukhman, Andrey 15, 56, 234
Bullyncck, Maarten 72
Buono, Amy 193
Burak, Guy 83, 234
Büttner, Jochen 6, 15, 28, 32, 46, 51, 56, 57, 59, 61, 203, 234

C

Callard, Felicity 85, 106, 234, 278
Calvo-Lopez, José 194
Campos, Luis 380
Camps, Celine 192, 234
Cândido da Silva, André Felipe
 141
Caplan, Jane 80, 234
Carey, Daniel 102
Carrier, Martin 114, 234
Carroy, Jacqueline 86
Carson, John 89, 235
Casper, Stephen 106
Cassou-Nogues, Pierre 273
Castagnetti, Giuseppe 15, 37, 235
Casties, Robert 56, 58, 59, 203,
 204, 205, 235
Cattaneo, Angelo 195
Cavazzini, Andrea 200
Ceglia, Francesco Paolo de 235
Cesar De Mattos, Adriana 235
Ceulemans, Anne-Emmanuelle
 195
Chadarevian, Soraya de 139, 197
Chamayou, Grégoire 15, 71, 72,
 85, 225, 235, 280
Charmantier, Isabelle 222
Chemla, Karine 72, 94, 235
Cheung, Tobias 114, 235
Chimisso, Cristina 200
Choudhury, Suparna 15, 66, 84,
 105, 222, 235, 278, 280
Christie, John 94, 235
Clarke, Mark 175, 176, 194, 235
Cleempoel, Koenraad van 195
Coghe, Samuël 145, 235
Cohen-Cole, Jamie 138
Collet, Dominik 102
Collins, Edward 102
Conant, James 88
Cook, Harold 175
Cooper, Barbara M. 141
Cooter, Roger 106
Cottebrune, Anne 142
Creager, Angela 73, 88
Crippa, Davide 158, 236, 158

Crull, Elise 236

Cryle, Peter 170

Csiszar, Alex 80, 236

D

Dacome, Lucia 193

Dai, Lianbin 83, 236

Damerow, Julia 36, 56, 205

Damerow, Peter 8, 15, 20, 24, 31,
 45, 51, 57, 58, 60, 209, 222, 223,
 236, 277

Darling, Karen 88

Darnell, Regna 138

Daston, Lorraine 6, 15, 65, 67,
 70, 72, 77, 81, 82, 85, 86, 88,
 100, 104, 138, 197, 218, 221,
 222, 223, 224, 226, 236, 269,
 272, 273, 274, 283, 284, 382

Davis, Lennard 171

Davis, Sophia Danielle 113, 236

Debaise, Didier 114, 236, 280

Debru, Claude 200

Debuiche, Valérie 158, 159, 158

Delaporte, François 199

Demeter, Tamás 114, 236, 280,
 380

De Pierris, Graciela 155

De Risi, Vincenzo 6, 17, 153, 155,
 159, 161, 226, 236, 278

Derman, Joshua 87

Devasher, Rohini 64, 227, 236

Días, Nélia 69, 237

Divarci, Lindy 18, 51, 58

Draelants, Isabell 18

Drucker, Donna 72

Dubourg Glatigny, Pascal 192

Düppe, Till 89

Dupree, Mary Helen 110

Dupré, Sven 6, 17, 132, 173, 174,
 175, 176, 177, 178, 179, 180,
 184, 189, 192, 195, 237, 216,
 218, 223, 224, 186, 269, 273,
 274, 278

E

Eastaugh, Nicholas 195

Ebke, Thomas 114, 200, 237, 280

Eckert, Michael 37

Edwards, Elizabeth 68

Efstathiou, Sophia 150, 237

Egloff, Rainer 87

Egmond, Florike 195

Egorova, Yulia 142

Ehlers, Sarah 141

Eijk, Philipp van der 218

Eklöf, Jenny 73

Elazar, Michael 33, 237, 280

Elkana, Yehuda 9, 20, 51, 63, 237

El Shakry, Omnia 141

Enescu, Raluca 168, 237

Engler, Olaf 18, 42, 51, 52, 53,
 221, 237, 380, 381

Engstrom, Eric 151, 237

Epplé, Moritz 14

Epstein, Steve 85

Erickson, Paul 82, 87, 237

Eskildsen, Kasper Risbjerg 237

Esposito, Teresa 194

Estévez Durey, David Daniel 237
Eugenio Pérez, Guillermo de
 113, 238

Ezra, Ruth 194

F

Fakiner, Nike Verena 113, 238

Falk, Raphael 142

Farge, Marie 94, 238

Farhat, Georges 194

Farinelli, Franco 154

Fauvel, Aude 113, 238

Fearnley, Andrew M. 113, 150,
 238, 280

Feest, Uljana 197

Fehrenbach, Frank 193

Feldhay, Rivka 33, 100, 101, 238

Felsch, Phillip 216

Ferron, Isabella 151, 238

Feuerhahn, Wolf 86

Fick, Hans Dietrich 39, 238

Field, J.V. 194

- Fiorani, Francesca* 194
Fisher, Jill 85
Fjaestad, Maja 238, 280
Fleck, Christian 87
Fleming, Martha 80, 102, 238, 278
Forrester, John 14, 85, 86, 87
Fortun, Mike 142
Freitas, Fabio 238
Frenkel, Viktor J. 381
Fressoz, Jean-Baptiste 72
Freudenthal, Gideon 238
Friedman, Judith 114, 239, 280
Friedman, Michael 53, 94, 114, 154, 155, 239
Friedrich, Bretislav 37
Friedrich, Markus 77, 239
Frumer, Yulia 113, 239
Fuechtner, Veronika 142
Fujimura, Joan H. 140, 146
Fuller, Steven 106
Fullilove, Courtney 80, 239
Fumagalli, Paul 272
- G**
Gabel, Isabel 113, 239
Gainty, Caitjan 85
Galbaatar, Tuvdendorj 239
Galison, Peter 88
Galluzzi Bizzo, Maria Letícia 141
Galluzzi, Paolo 61
Gänger, Stefanie 69, 239, 279, 280
Gannett, Lisa 142
Garber, Daniel 88, 155
Garrido, Juan Manuel 114, 239
Garske, Ellen 215
Gasché, Rodolphe 114, 239
Gatto, Maurizio 239
Gaudenzi, Nicolás 239
Gausemeier, Bernd 15, 114, 124, 240, 125, 125
Gavroglu, Kostas 38, 53, 54
Geiger, Ido 240
Geimer, Peter 68, 197, 218
Geisthövel, Alexa 151, 240
- Geller, Florentina Badalanova* 48, 381
Geller, Mark 22, 218, 381, 382
Gelleri, Gabor 102
Germanese, Donatella 15, 90, 240
Germann, Pascal 146, 240
Geroulanos, Stefanos 94, 240
Gerovitch, Slava 138
Gerritsen, Anne 195, 240
Gess, Nicola 110
Geus, Klaus 382
Giannakopoulou, Polyxeni 96, 240
Giannini, Giulia 18, 240
Gierer, Alfred 382
Giere, Ronald 88
Gil-Riaño, Sebastián 150, 240
Ginsburg, Faye 68
Ginzburg, Carlo 277
Gissis, Snait 142
Goldstein, Jan 86
Gonçalves Martín, Johanna 73, 150, 240
Gordin, Michael D. 81, 82, 138, 241
Görz, Günther 27, 28, 205, 240, 274
Göttler, Christine 189, 194
Gottstein, Klaus 382
Gouyon, Jean-Baptiste 113, 241
Grachova, Sofiya 150, 241
Grafton, Anthony 6, 82, 83, 241
Gramelsberger, Gabriele 139
Granada, Miguel Ángel 27, 29
Graßhoff, Gerd 72, 218
Gray, Jeremy 155
Greist, Alexa 194
Grimaldi, Carmine 113, 241
Gross, Sky 106
Grote, Mathias 381
Grunberg, Angela 110
Gründler, Beatrice 48
Gutas, Dimitri 48
Güttler, Nils 111, 241, 273, 279, 280
- H**
Habinek, Jacob K. 113, 241
Hacking, Ian 88
Haffner, Jeanne M. 151, 241
Hagner, Michael 197
Haines, Margaret 57
Halpern, Orit 94, 139, 241
Hammer, Carmen 15, 36, 62, 241
Hammerstein, Peter 197
Hanke, Christine 139
Hanson, Marta 241
Härdle, Wolfgang 272, 273
Harris, Randy 138
Harwood, Jonathan 147, 242
Hasler, Felix 94, 242
Hatfield, Gary 155
Haug, Henrike 195
Haverkamp, Anselm 200
Heesen, Anke te 192, 197, 218
Heinich, Nathalie 87
Heise, Ursula K. 69
HE, Juan 242
Helbig, Daniela 113, 242, 280
Hellström, Petter 142
Henning, Björn 380
Henry, Christie 88
Herfeld, Catherine 113, 242, 281
Hermann, Beatrice 18
Herrgott, Gerhard 197
Herrmann, Hans Christian von 218
Hesselink, Liesbeth 96
Heumann, Ina 114, 242, 281
Hiebert, Elfrieda 10
Hiebert, Erwin 10
Hills, Paul 194
Hinrichsen, Ralf 215
Hitlin, Steven 87
Hochadel, Oliver 150, 242
Hoffmann, Christoph 15, 114, 197, 242, 281, 381
Hoffmann, Dieter 15, 36, 37, 38, 40, 52, 62, 221, 222, 224, 242, 269, 284, 381
Höhler, Sabine 139
Holterhoff, Anna 18, 27, 28, 29, 242

Hon, Giora 38, 52, 114, 242
Hoquet, Thierry 114, 243
Hoßfeld, Uwe 142
Høyrup, Jens 382
Hsia, Florence 80, 243
Huentelmann, Axel Caesar 151, 243
Hui, Alexandra 110
Huijnen, Pim 243
Hume, Brad 114, 151, 243
Hunter, Matthew C. 195
Hütten, Moritz 18, 243
Hyman, Ludmila 243, 281
Hyman, Malcolm 45
Hyslop, Scott 34, 243

I

Igo, Sarah 80, 85, 243
Imhof, Dirk 195
Inaba, Hajime 18, 243

J

Jähnert, Martin 18, 36, 39, 40, 243, 284
Jahn, Josephine 114, 124, 127, 127
James, Jeremiah 15, 18, 37, 40, 244
Janiak, Andrew 155
Jankovic, Vladimir 80, 244
Janousch, Andreas 244
Janssen, Michel 38
Jasanoff, Sheila 73
JEON, Chihyung 72, 78, 244, 281
Jesseph, Douglas 155
Jirikowski, Günther 381
Joaquim, Leyla Mariane 40, 113, 244
Joas, Christian 18, 36, 37, 38, 40, 51, 54, 62, 244, 272, 281
Johnson, Jenell 106
Johnston, Stephen 195
Jonckheere, Koenraad 188
Jones, Alexander 154
Jonge, Krista De 194
Jordi Taltavull, Marta 39, 244
Joseph, John E. 138
Jurkowitz, Edward 40, 244

K

Kahn, Didier 194, 195
Kaiser, David 88
Kakaliouras, Ann M. 147, 244
Kamlah, Andreas 52
Kammer, Stephan 114, 244
Kantel, Jörg 57, 58, 59, 203, 223
Kant, Horst 15, 37, 39, 40, 62, 224, 245
Kao, Philip 38
Kaplan, Judy 138
Karl, Barbara 195
Karlin, Jennifer 85
Kashanipour, Ryan Amir 113, 245
Kaster, Robert 83, 245
Katsaloulis, Iraklis 114, 245
Katzir, Shaul 38, 39, 245
Kayser, Sabine 18
Keller, Agathe 72
Keller, Felix 87, 139
Kelley, Theresa M. 94, 245, 284
Kern, Hartmut 245
Kerssenbrock-Krosigk, Dedo von 186, 195
Kessentini, Ruth 215
Kessler, Bruno 193
Keuck, Lara 150, 245
Kheirandish, Elaheh 194
Kieffer, Fanny 195
Kiely, Garrett 88
Kirby, Jo 195
Kirsh, Nurit 142
Klamm, Stefanie 68, 112, 245, 279, 281
Klein, Cornelia 58
Klein, Joel 113, 245
Klein, Judy 82, 245
Klein, Ursula 15, 18, 34, 114, 194, 195, 245, 269, 272, 273, 274, 278, 279
Klenhova, Jana 113, 246
Klöpffer, Hannes 63
Knauff, Falk-Juri 15, 56, 204, 226, 246, 281
Knolle, Johannes 38, 246

Kogge, Werner 381
Kohlstedt, Sally Gregory 96
Kojevnikov, Alexei 37, 38, 246
Kolboske, Birgit 18
Konečný, Peter 114
Konen, Peter 246
König, Wolfgang 218
Kopsky, Georg 38, 246
Kormos-Buchwald, Diana L. 36, 246
Kort, Pamela 94, 114, 246
Krajewski, Markus 72, 80, 246
Krämer, Fabian 112, 246, 279, 281, 284
Krampf, Arie 50, 246, 281
Krauthausen, Karin 114, 246, 281, 381
Krebernik, Manfred 57, 60
Krekel, Christoph 195
Kremer, Richard 72, 80, 247
Kreuder-Sonnen, Katharina 247
Krois, John Michael 381
Küçük, Harun 103, 247, 279, 281
Kühnast, Antje 141
Kundert, Ursula 80, 247
Kursell, Julia 15, 110, 114, 198, 247, 278, 281
Kusukawa, Sachiko 195
Kvíčalová, Anna 110
Kypta, Ulla 113, 247, 279, 282

L

Lacour, Pierre-Yves 102, 113, 247
Laitko, Hubert 278
Lange, Britta 110
Langlitz, Nicolas 84, 221, 223
Laplane, Lucie 113, 247
Laubichler, Manfred 43, 63, 197, 247
Laufenberg, Mike 150, 247, 281
Lawrence, Adam 113, 247, 281
Laywine, Alison 154
Ledebur-Wicheln, Sophie 72, 114, 247, 279, 281
Leduc, Christian 159
Lee, Clarissa 248

- Leendertz, Ariane* 278
Lefebvre, Jean-Pierre 86
Lefèvre, Wolfgang 15, 43, 225, 248, 269, 381
Lefkaditou, Ageliki 150, 248
Lehmann-Brauns, Susanne 380
Lehmann, Katrin von 130, 248
Lehner, Christoph 15, 18, 34, 35, 37, 40, 51, 63, 222, 223, 248, 274
Leitão, Henrique 278
Lemke, Thomas 139
LeMOV, Rebecca 69, 78, 82, 87, 248
Leng, Kirsten 96, 99, 248, 281
Leonelli, Sabina 139
Leong, Elaine 6, 15, 66, 96, 101, 107, 108, 177, 248
Leonhard, Karin 17, 174, 175, 183, 184, 194, 195, 224, 248
LI, Liang 248
Limoges, Camille 199
Lipphardt, Veronika 6, 17, 129, 131, 132, 136, 138, 139, 140, 141, 142, 192, 216, 218, 221, 223, 248, 269, 272, 274, 277
Littlefield, Melissa 106
Littleton, Judith 141
Llobat, Ximo Guillem 114, 248, 282
Lockhart, William 113, 248, 279
López Beltrán, Carlos 114, 141, 201, 249
Löwy, Ilana 80, 249, 381
Lücke, Martin 151, 249
Ludwig, David 138
Lunbeck, Elizabeth 85, 87, 104
Lund, Hannah Lotte 17, 249
Lüst, Reimar 278
Luz, Nimrod 249
- M**
- Maas, Harro* 94, 249
Mackenzie, Adrian 139
Maclot, Petra 194
MacPhail, Beate 215
- Magone, Rui* 249
Maienschein, Jane 43
Malkin, Irad 249
Mamine, Tomoko 198
Manoff, Marlene 80, 249
Mansnerus, Erika 139
Mar Gago, Maria do 114, 249
Margocsy, Daniel 102
Margulies, Daniel 106
Marks, Jonathan 142
Martelli, Matteo 194, 195
Martin, Emily 85
Mateescu, Oana 113, 249
Mateos, Gisela 114, 249
Matyssek, Angela 94, 249, 380
Maxwell, Susan 192
Mayer, Andreas 15, 72, 81, 85, 86, 87, 90, 104, 222, 250
Mayer, Thomas 150, 250
M'charek, Amade 140
McKay, Francis 113, 250
McLaughlin, Peter 30, 197, 250
McNally, Ruth 139
McNamee, Megan 83, 113, 250
Meganck, Tine 194
Meinel, Christoph 14
Mendell, Henry 154
Mendelsohn, Andrew 94, 250
Merz, Martina 139
Messner, Angelika 250
Méthot, Pierre-Olivier 200
Métraux, Alexandre 381
Meunier, Robert 140, 148, 250, 274, 279, 282
Meyer, Sophie 114, 124, 127, 250, 127
Meyers, Todd 170, 200
Midwinter, Charles 38, 250
Mihoci, Andrija 272
Milam, Erika Lorraine 94, 250
Miller, David Marshall 159, 160, 159
Miller, Peter N. 195
Miller, Thomas Ross 151, 251
Mills, Mara 169
Minkowski, Christopher 83, 251
- Missfelder, Jan-Friedrich* 110
Mitman, Gregg 68, 85
Miyake, Teru 113, 251
Molino, Paola 83, 102, 251
Monaldi, Daniela 39
Montoto Echevarría, Arturo 114, 251
Moran, Sarah Joan 194
Morat, Daniel 110
Morawski, Jill 85
Morel, Thomas 251
Morris-Reich, Amos 141, 142, 151, 251
Mosßburger, Marija 197
Most, Glenn W. 6, 17, 82, 83, 251
Mota, Bernardo 34, 154, 251
Muhle, Maria 200
Müller-Tamm, Jutta 217, 218
Müller-Wille, Staffan 102, 137, 139, 140, 197, 201, 220, 222, 251, 277
Mumma, John 160, 251, 282
Munck, Bert De 176
Munz, Tania 15, 104, 138, 223, 251, 282
Murdock, Caitlin 94, 252
Murphy, Michelle 139
- N**
- Nag, Anindita* 113, 252, 282
Nakane, Michiyo 38
Nanni, Romano 34
Napolitani, Daniele 34
Nappi, Carla 80, 252
Naquin, Susan 252
Nasim, Omar W. 113, 114, 252, 282
Navarro, Jaume 37, 252
Neis, Dalia 181, 252
Nelson, Alondra 148, 252
Nelson, Sean 190, 195, 252
Németh, András 15, 82, 83, 91, 252
Nenci, Elio 252
Nergui, Basan 252
Neswald, Elizabeth 94, 114, 252

- Neumaier, Christopher* 87
Neven, Sylvie 174, 175, 183, 195, 253
Newman, William 192, 195
Nickel, Hildegard 218
Niewöhner, Jörg 273
Nirenberg, David 48
Nordlund, Christer 80, 253
Nowacki, Horst 253
Nowotny, Helga 220
Nummedal, Tara 194
Nye, Mary Jo 277
Nyssa, Zoe 85, 113, 253
- O**
- O'Dochartaigh, Eavan* 102
Oertzen, Christine von 15, 67, 71, 72, 79, 95, 96, 97, 205, 221, 226, 253, 272, 273, 274
Oltrogge, Doris 177, 192, 195
Omodeo, Pietro Daniel 15, 18, 24, 27, 28, 29, 34, 48, 222, 253, 381, 382
Onaga, Lisa 114, 253, 282
Ordóñez Rodríguez, Javier 253
Ortega, Francisco Javier Guerrero 84, 222, 253
Ossendrijver, Mathieu 72
Otis, Laura 94, 114, 197, 253
Ottner-Diesenberg, Christine 80, 254
Overbeck, Anne 99, 113, 254
- P**
- Paaß, Claudia* 17
Pacheco, José M. 50, 254
Pádua, José-Augusto 69
Paethe, Cathleen 254
Palfreyman, Harriet 113, 254
Papoulias, Constantina 106
Paramei, Galina 195
Park, Jin-kyung 141
Park, Julie 141
Park, Katharine 103, 254
Parolini, Giuditta 150, 254
Peiffer, Jeanne 179, 192
- Perlina, Anna* 18, 52, 87, 254
Pestre, Dominique 91, 254
Peterson, Heather 114, 254
Petrou, Marissa Helene 113, 254
Phalkey, Jahnvi 114, 255
Pickersgill, Martyn 106
Pietzke, Anke 199, 215
Pimentel, Juan 102
Plofker, Kim 80, 255
Plumb, Christopher 113, 255, 279, 282
Plümecke, Tino 148, 255, 282
Podgorny, Irina 15, 69, 114, 255
Pohl, Michael 381
Pols, Hans 141
Pomata, Gianna 96
Pontani, Filippomaria 83, 255
Poplow, Marcus 255
Portuondo, Maria 102
Potthast, Jörg 272
Pravica, Sandra 114, 200, 255
Preda, Alexandru 87
Presas i Puig, Albert 15, 255, 282, 381
Principe, Lawrence 186, 192, 195
Proust, Christine 72
Pugliano, Valentina 188, 194, 255
Pugliese, Ida 102
Pulte, Helmut 34
Putnam, Constance 96
- R**
- Rabouin, David* 154
Radeck, Antje 197
Radick, Gregory 94, 138, 255
Radin, Joanna 69, 149, 256
Ragep, F. Jamil 100, 101, 256
Ragep, Sally P. 100, 101
Raina, Dhruv 80, 256
Raj, Kapil 86
Ramplig, Jennifer 194, 195
Ramsingh, Brigit 113, 256, 282
Rangel de Almeida, João 150, 256
Raphael, Renée 278
Rasch, Manfred 278
- Raymundo, José Emmanuel* 151, 256
Raynaud, Dominique 194
Raz, Amir 106
Regier, Jonathan 157
Reinhardt, Carsten 37, 73, 80, 114, 256
Reisch, George 88
Reiß, Christian 114, 256
Rémy, Catherine 73
Renn, Jürgen 5, 15, 18, 19, 25, 29, 30, 31, 33, 35, 37, 40, 41, 42, 43, 45, 46, 48, 49, 50, 51, 52, 53, 54, 58, 59, 60, 61, 63, 218, 221, 222, 223, 224, 226, 227, 256, 269, 272, 273, 284, 380, 382
Rentetzi, Maria 95, 96, 114, 256
Ren, Xinguo 38
Reynolds, Andrew 94, 256
Rheinberger, Hans-Jörg 6, 15, 114, 142, 197, 198, 199, 220, 221, 222, 223, 224, 257, 269, 274, 276, 283, 380, 381
Richard, Nathalie 86, 87
Richards, Robert J. 85, 86, 88, 138
Rickles, Dean 41, 42, 257, 282
Rieger, Simone 15, 51, 56, 57, 58, 60, 61, 62, 257
Rijks, Marlise 188, 192, 257
Rinke, Patrick 38
Risbjerg Eskildsen, Kasper 94
Ritvo, Harriet 94, 257
Roccasecca, Pietro 192, 194
Roelcke, Volker 114, 257
Roosth, Sophia 114, 257, 282
Roque, Ricardo 142, 257
Rosenhagen, Raja 257
Rosol, Christoph 50, 113, 114, 257
Ross Winthereik, Britt 139
Roux, Sophie 257
Ruge, Nina 18
Rusk, Bruce 258

S

- Sabeen, David* 14, 258
Sachse, Carola 258, 278
Safier, Neil F. 94, 102, 258
Salisbury, Donald 25, 41, 42, 224, 258
Samir, Imad 18, 258
Sander, Frank 59
Santesmases, María Jesús 201
Saß, Maurice Yves-Christian 194
Savoth, Eric 113, 258
Schäfer, Armin 72
Schäfer, Dagmar 6, 17, 204, 225, 226, 258, 283
Scheffler, Mathias 38
Schemmel, Matthias 15, 18, 23, 24, 25, 27, 28, 31, 33, 41, 42, 48, 51, 57, 58, 204, 224, 258, 274, 278, 381
Schickore, Jutta 197
Schiefenhövel, Wulf 24, 258
Schirmacher, Arne 15, 37, 38, 40, 221, 258, 272, 273
Schivelbusch, Wolfgang 94, 258
Schlich, Thomas 114, 259, 277
Schlögl, Robert 50
Schlünder, Martina 99, 150, 259, 273
Schmaltz, Florian 259
Schmidgen, Henning 15, 114, 198, 199, 223, 259, 282, 284, 381
Schmidle, Wolfgang 15, 56, 259, 282
Schmidt-Biggemann, Wilhelm 218
Schmidtke, Sabine 22
Schmidt-Pfister, Diana 73
Schmitz-von Ledebur, Katja 195
Schneider, Jochen 17
Schneider, Marius 61
Schoepflin, Urs 17, 57, 58, 101, 197, 199, 208, 214, 215, 223, 259, 279, 381
Scholz, Peter 194
Schön, Wolfgang 21
Schöttler, Peter 114, 199, 259, 277, 381
Schramm, Katharina 140, 141, 259
Schröter, Petra 18
Schüller, Volkmar 15, 34, 259, 380
Schwartz, Manuela 110
Schwegman, Jeffrey 114, 259, 282
Schwerdt, Matthias 199, 215
Schwerin, Alexander von 142, 150, 259
Sebastiani, Valentina 193
Seidengart, Jean 27, 28
Sentker, Andreas 220
Sepkoski, David 15, 67, 69, 71, 80, 92, 259
Serpente, Norberto 114, 260
Serrano, Elena 97, 113, 260
Shank, J.B. 194
Shapiro, Ryan 73
Shea, William R. 260
Shen, Grace Yen 260
SHI, Yunli 260
Sibum, H. Otto 114, 260
Sichau, Christian 380
Siebert, Harald 27, 260
Sigurðsson, Skúli 260
Silva, Indianara 40
Simões, Ana 14
Skaar-Jacobsen, Anja 38
Skinner, David 151
Slaby, Jan 222
Sluiter, Ineke 83, 260
Smith, Mark 194
Smith, Pamela H. 14, 100, 101
Sofronieva, Tzveta 62, 260
Solhdju, Katrin 197
Sommer, Marianne 143
Sonderland, Hilary 73
Sørensen, Estrid 272
Spinks, Jennifer 113, 260, 282
Stachel, John 41, 260
Stadler, Friedrich 52
Stadler, Max 105, 114, 261, 283, 381
Stahnisch, Frank W. 114, 261, 380, 381
Stan, Marius 161, 261
Stark, Laura 73, 85
Stedall, Jacqueline 57, 204, 261
Stein, Claudia 261
Steingart, Alma 113, 261
Steinhauser, Thomas 37
Steinle, Friedrich 72, 197, 218
Stinson, Catherine 114, 261
Storeck, Gunthild 18
Strasser, Bruno J. 139
Sturm, Thomas 82, 104, 138, 261
Suárez, Edna 201
Summers, David 194
Sundermeyer, Kurt 41, 42
SUN, Xiaochun 261
Surendorf, Kai 58
Swan, Claudia 193
Sysling, Fenneke 151, 261

T

- Taltavull, Marta Jordi* 226
Tantner, Anton 72
Teicher, Amir 142, 151, 261
Teich, Mikuláš 382
Teissier, Pierre 114, 262, 283
Testa, Giuseppe 220
Thielemann, Andreas 180
Thiering, Martin 24, 262, 382
Thimann, Michael 192
Thoden, Klaus 56, 57, 204, 262
Tholen, Georg Christoph 114, 262
Thomas, Julia Adeney 69
Thompson, Carl 102
TIAN, Miao 262
Tillberg, Margareta 262
Timmermann, Anke 193, 195
Tkaczyk, Viktoria 6, 15, 66, 109, 110, 262, 272, 273, 278
Topalov, Christian 86
Tornay, Magaly 114, 262
Tournès, Dominique 72
Trachtenberg, Marvin 194
Trakulhun, Sven 102
Tramelli, Barbara 177, 192, 194, 262

- Tresch, John* 94, 262
Trischler, Helmuth 278, 380
Trzeciok, Stefan 31, 48, 262
Tsouparopoulou, Christina 57, 263, 283
Tucker, Jennifer 68
Tugendhaft, Aaron 83, 263
Tupikova, Irina 24, 27, 263, 382
- U**
Urzúa Contreras, Jorge Patricio 56, 73, 205, 263
- V**
Vacín, Luděk 57, 263, 283
Vackimes, Sophia 114, 263
Vaerenbergh, Jeroen Van 195
Vallejo, Mauro Sebastián 114, 263, 283
Valleriani, Matteo 15, 18, 27, 28, 30, 31, 32, 33, 48, 49, 61, 178, 224, 263, 272, 273, 284
Vandervellen, Pascale 195
Vargha, Dora 98, 263
Ventura Santos, Ricardo 141, 149, 263
Vermeir, Koen 157, 273
Vermeulen, Han F. 50, 263, 382
Vertesi, Janet 68
Vidal, Fernando 15, 67, 69, 81, 84, 86, 222, 224, 227, 263, 278, 283
Vierck, Henning 62
Vimieiro Gomes, Ana Carolina 151, 264
Vingron, Martin 197
Visigalli, Paolo 83, 264
Vitali, Samuel 264
Vlahakis, George N. 38, 61, 264
Vogel, Klaus 27, 28, 264, 274
Vogt, Annette 15, 95, 98, 264, 272, 273, 274, 382
Vollandt, Ronny 83, 264
Volmar, Axel 110, 114, 264
Vongsathorn, Kathleen 99, 113, 264
Voss, Julia 106, 197
- W**
Wade, Peter 142
Wagner, Berit 194
Wahrig, Bettina 197
Wahsner, Renate 15, 264, 380, 381, 382
Waisse Priven, Silvia 114, 264
Wakefield, André 80, 264
Walker, Oriana 113, 265
Walther, Daniel J. 151, 265
Walther, Peter Th. 272
WANG Cong, Harriet 38, 265
Wang, Weining 274
Warren, Daniel 265
Watkins, Elizabeth 95, 96
Watkins, Eric 265
Watson, Cecelia 15, 92, 113, 265
Waysand, Georges 38
Wazeck, Milena 15, 221, 265, 283, 284
Weerd, Hilde de 265
Wegener, Mai 114, 265
Weinberg, Joanna 83, 265
Weindling, Paul 142
Weingart, Peter 114, 265
Weiss, Dieter G. 381
Welsh, Caroline 110
Wendt, Helge 18, 45, 46, 48, 49, 50, 61, 219, 227, 265
Werner, Anja 167, 266
Werner, Klaus E. 17, 180, 194, 266
Wesley, Morgan 195
Wessely, Christina 114, 266, 283
Westermann, Andrea 113, 266, 283
Weststeijn, Matthijs 191, 266, 283
Wharton, Steve 191, 195, 266
White, Paul 102
Whitmer, Kelly J. 266, 283
Widmer, Alexandra 17, 134, 136, 140, 141, 227, 266
Wiedemann, Felix 142, 266
Wilder, Kelley 68, 104
Wilding, Nick 277
Willenborg, Josef 56, 266
- Wille, Robert-Jan* 151, 266
Williams, Alan 195
Williams, Simon 106
Winter, Alison 85, 86
Winter, Christine 151, 266
Wintergrün, Dirk 17, 56, 57, 59, 101, 205, 207, 267, 278
Wise, M. Norton 14, 88, 94, 267
Wisselgren, Per 80, 267, 283
Wittmann, Barbara 15, 114, 198, 225, 267
Wolf, Frieder Otto 200
Wolf, Gerhard 278
Wolf, Herta 114, 267, 277
Wolf, Rebecca 110
Wolters, Gereon 38, 52, 267
Wragge-Morley, Alexander 113, 267, 283
Wübben, Yvonne 93, 222, 267
Wulz, Monika 114, 200, 267, 283
Wunderlich, Falk 267
Wynne, Brian 73
- Y**
Yang, Guoqing 267
Young, Allan 106
- Z**
Zacharias, Sebastian 18, 42, 268
Zakariya, Nasser 113, 268, 283
Zemplén, Gábor Áron 114, 268
Zenner, Hans-Peter 50
Ziemer, Hansjakob 17, 93, 110, 224, 268
Ziemke, Anne 113, 268
Zittel, Claus 192
Zorzanelli, Rafaela Teixeira 113, 268

AURORA (VISUAL)

